

Overview

The KEMET T500 is a high-temperature product that offers optimum performance characteristics in applications with operating temperatures up to 200°C. The T500 is classified as MSL (Moisture Sensitivity Level) 1 under J-STD-020: unlimited floor life time at ≤ 30°C/85% RH.

Benefits

- Meets or exceeds EIA standard 535BAAC
- Weibull failure rate to B Level available
- Standard gold-plated termination
- RoHS Compliant
- Operating temperature range of -55°C to +200°C
- 100% steady-state accelerated aging at 200°C
- Voltage derating is 40% at 200°C
- Qualified at 1,000 hours of life test at 200°C
- Taped and reeled per EIA 481
- Meets MSL 1 requirements for Pb-free assembly according to JEDEC J-STD-020 (*)
- Surge current options available

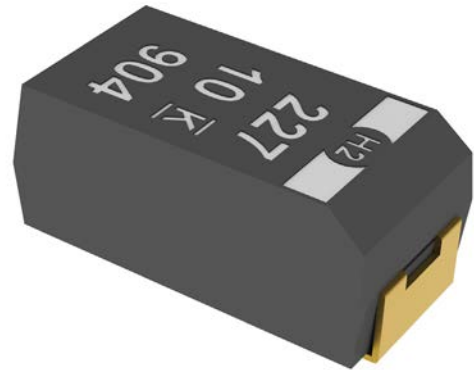

Applications

Typical applications include decoupling and filtering in down-hole, defense, and aerospace industries.

K-SIM

For a detailed analysis of specific part numbers, please visit ksim.kemet.com to access KEMET's K-SIM software. KEMET K-SIM is designed to simulate behavior of components with respect to frequency, ambient temperature, and DC bias levels.

Ordering Information

T	500	X	227	M	010	A	G	61	10	
Capacitor Class	Series	Case Size	Capacitance Code (pF)	Capacitance Tolerance	Rated Voltage (VDC)	Failure Rate/Design	Termination Finish	Performance	ESR	Packaging (C-Spec)
T = Tantalum	High Temperature 200°C	B C D X	First two digits represent significant figures. Third digit specifies number of zeros.	K = ±10% M = ±20%	006 = 6.3 010 = 10 016 = 16 035 = 35 050 = 50	A = N/A B = 0.1%/1,000 hours	G = Gold-plated	61 = Surge None 62 = Surge at 25°C after Weibull 63 = Surge -55°C and +85°C after Weibull	10 = Standard ESR	Blank = 7" reel 7280 = 13" reel

Performance Characteristics

Item	Performance Characteristics
Operating Temperature	-55°C to 200°C
Rated Capacitance Range	4.7 – 220 µF at 120 Hz/25°C
Capacitance Tolerance	K Tolerance (10%), M Tolerance (20%)
Rated Voltage Range	6.3 – 50 V
DF (120 Hz)	Refer to Part Number Electrical Specification Table
ESR (100 kHz)	Refer to Part Number Electrical Specification Table
Leakage Current	≤ 0.01 CV (µA) at rated voltage after 5 minutes

Qualification

Test	Condition	Characteristics				
Endurance	200°C at 0.4 x V _R , 1,000 hours (**)	Δ C/C	Within ±10% of initial value			
		DF	Within initial limits			
		DCL	1 mAmp maximum			
		ESR	Within initial limits			
Storage Life	200°C at 0 volts, 1,000 hours	Δ C/C	Within ±10% of initial value			
		DF	Within initial limits			
		DCL	1 mAmp maximum			
		ESR	Within initial limits			
Humidity	85°C, 85% RH, 0 volts, 1,000 hours	Δ C/C	Within ±10% of initial value			
		DF	Within initial limits			
		DCL	Within initial limits			
		ESR	Within initial limits			
Temperature Stability	Extreme temperature exposure at a succession of continuous steps at +25°C, -55°C, +25°C, +85°C, +125°C, +25°C		+25°C	-55°C	+85°C	+150°C
		Δ C/C	IL*	±10%	±10%	±20%
		DF	IL	IL	1.5 x IL	1.5 x IL
		DCL	IL	N/A	10 x IL	12 x IL
Mechanical Shock/ Vibration	MIL-STD-202, Method 213, Condition I, 100 G peak MIL-STD-202, Method 204, 10 Hz to 2,000 Hz, 5 G for 20 minutes, 12 cycles each of 3 orientations	Δ C/C	Within ±10 of initial value			
		DF	Within initial limits			
		DCL	Within initial limits			

*IL = Initial limit

**

Electrical Characteristics

Impedance & ESR vs. Frequency

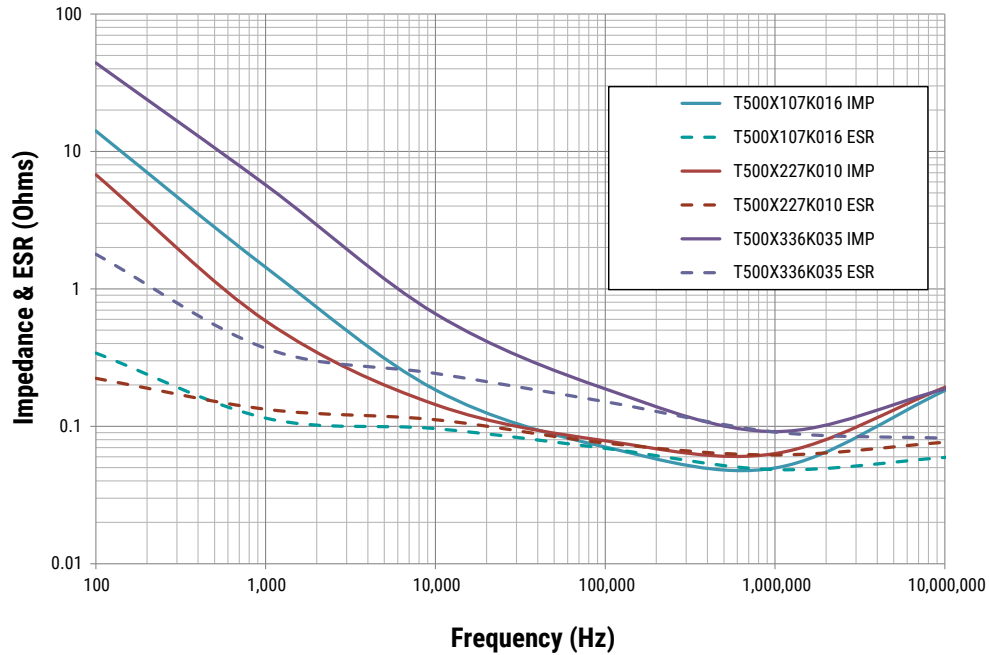

The measurements were taken at room temperature (25°C)

Capacitance vs. Frequency

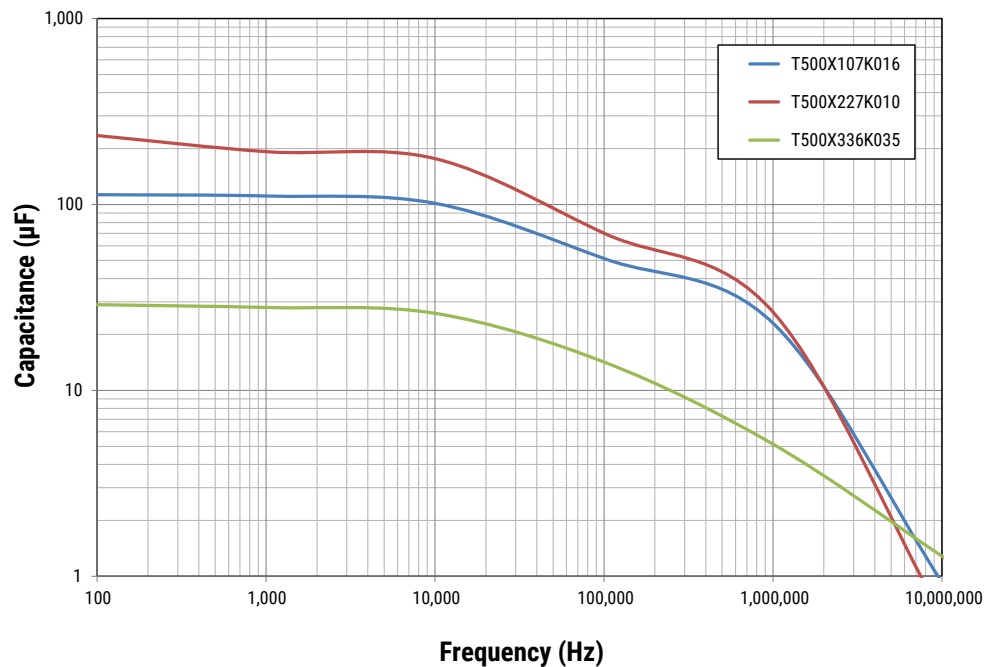

The measurements were taken at room temperature (25°C)

Dimensions – Millimeters

CATHODE (-) END VIEW

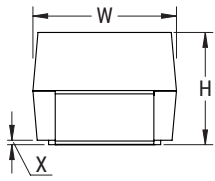

SIDE VIEW

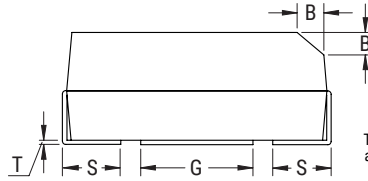

ANODE (+) END VIEW

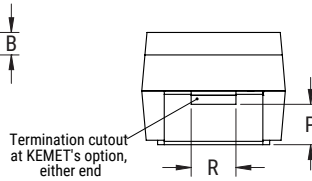

BOTTOM VIEW

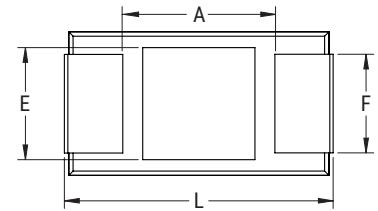

Case Size		Component												
KEMET	EIA	L	W	H	F ±0.1 ±(0.004)	S ±0.3 ±(0.012)	B ±0.15 (Ref) ±0.006	X (Ref)	P (Ref)	R (Ref)	T (Ref)	A (Minimum)	G (Ref)	E (Ref)
B	3528-21	3.5±0.2 (0.138±0.008)	2.8±0.2 (0.110±0.008)	1.9±0.2 (0.075±0.008)	2.2 (0.087)	0.80+0.1/-0.3 (0.032+0.004/-0.011)	0.4 (0.016)	0.10±0.10 (0.004±0.004)	0.5 (0.020)	1.0 (0.039)	0.13 (0.005)	1.9 (0.075)	1.8 (0.071)	2.2 (0.087)
C	6032-28	6.0±0.3 (0.236±0.012)	3.2±0.3 (0.126±0.012)	2.5±0.3 (0.098±0.012)	2.2 (0.087)	1.3 (0.051)	0.5 (0.020)	0.10±0.10 (0.004±0.004)	0.9 (0.035)	1.0 (0.039)	0.13 (0.005)	2.9 (0.114)	2.8 (0.110)	2.4 (0.094)
D	7343-31	7.3±0.3 (0.287±0.012)	4.3±0.3 (0.169±0.012)	2.8±0.3 (0.110±0.012)	2.4 (0.094)	1.3 (0.051)	0.5 (0.020)	0.10±0.10 (0.004±0.004)	0.9 (0.035)	1.0 (0.039)	0.13 (0.005)	3.8 (0.150)	3.5 (0.138)	3.5 (0.138)
X	7343-43	7.3±0.3 (0.287±0.012)	4.3±0.3 (0.169±0.012)	4.0±0.3 (0.157±0.012)	2.4 (0.095)	1.3 (0.051)	0.5 (0.020)	0.10±0.10 (0.004±0.004)	1.7 (0.067)	1.0 (0.039)	0.13 (0.005)	3.8 (0.150)	3.5 (0.138)	3.5 (0.138)

Notes: (Ref) – Dimensions provided for reference only.

Table 1 – Ratings & Part Number Reference

Rated Voltage	Working Voltage		Rated Cap	Case Code/ Case Size	KEMET Part Number	DC Leakage		DF	ESR	Maximum Allowable Ripple Current (rms)			Maximum Operating Temperature	MSL
	VDC at 85°C	VDC at +125°C				VDC at +200°C	µF			KEMET/EIA	(See below for part options)	µA at 25°C Maximum /5 Minutes		
6.3	4.2	2.5	6.8	B/3528-21	T500B685(1)006AG(3)10	0.5	5	6	3500	156	62	16	200	1
6.3	4.2	2.5	10	B/3528-21	T500B106(1)006AG(3)10	0.6	6	6	2800	174	70	17	200	1
6.3	4.2	2.5	15	B/3528-21	T500B156(1)006AG(3)10	0.9	9	6	3500	156	62	16	200	1
6.3	4.2	2.5	22	B/3528-21	T500B226(1)006AG(3)10	1.4	14	6	3500	156	62	16	200	1
6.3	4.2	2.5	33	C/6032-28	T500C336(1)006AG(3)10	2.1	21	6	1800	247	99	25	200	1
6.3	4.2	2.5	47	C/6032-28	T500C476(1)006AG(3)10	3.0	30	6	1800	247	99	25	200	1
6.3	4.2	2.5	68	C/6032-28	T500C686(1)006AG(3)10	4.3	43	6	1200	303	121	30	200	1
10	6.6	4.0	6.8	B/3528-21	T500B685(1)010AG(3)10	0.7	7	6	3500	156	62	16	200	1
10	6.6	4.0	10	B/3528-21	T500B106(1)010AG(3)10	1	10	6	2800	174	70	17	200	1
10	6.6	4.0	15	B/3528-21	T500B156(1)010AG(3)10	1.5	15	6	3500	156	62	16	200	1
10	6.6	4.0	47	D/7343-31	T500D476(1)010AG(3)10*	4.7	47	6	800	433	173	43	200	1
10	6.6	4.0	220	X/7343-43	T500X227(1)010(2)G(3)10*	22	220	10	250	812	325	81	200	1
16	10.6	6.4	4.7	B/3528-21	T500B475(1)016AG(3)10	0.8	8	6	6000	119	48	12	200	1
16	10.6	6.4	6.8	B/3528-21	T500B685(1)016AG(3)10	1.1	11	6	3500	156	62	16	200	1
16	10.6	6.4	10	B/3528-21	T500B106(1)016AG(3)10	1.6	16	6	2800	174	70	17	200	1
16	10.6	6.4	33	D/7343-31	T500D336(1)016AG(3)10	5.3	53	6	800	433	173	43	200	1
16	10.6	6.4	47	D/7343-31	T500D476(1)016AG(3)10	7.5	75	6	800	433	173	43	200	1
16	10.6	6.4	100	X/7343-43	T500X107(1)016(2)G(3)10*	16	160	8	250	812	325	81	200	1
20	13.4	8.0	22	D/7343-31	T500D226(1)020AG(3)10	4.4	44	6	800	433	173	43	200	1
20	13.4	8.0	33	D/7343-31	T500D336(1)020AG(3)10	6.6	66	6	700	463	185	46	200	1
25	16.8	10.0	6.8	D/7343-31	T500D685(1)025AG(3)10	1.7	17	6	1300	340	136	34	200	1
25	16.8	10.0	10	D/7343-31	T500D106(1)025AG(3)10	2.5	25	6	1000	387	155	39	200	1
25	16.8	10.0	15	D/7343-31	T500D156(1)025AG(3)10	3.8	38	6	1000	387	155	39	200	1
25	16.8	10.0	22	D/7343-31	T500D226(1)025AG(3)10	5.5	55	6	800	433	173	43	200	1
25	16.8	10.0	33	D/7343-31	T500D336(1)025AG(3)10	8.3	83	6	700	463	185	46	200	1
35	23.1	14.0	6.8	D/7343-31	T500D685(1)035AG(3)10	2.4	24	6	1300	340	136	34	200	1
35	23.1	14.0	10	D/7343-31	T500D106(1)035AG(3)10	3.5	35	6	1000	387	155	39	200	1
35	23.1	14.0	10	X/7343-43	T500X106(1)035(2)G(3)10*	3.5	35	6	700	486	194	49	200	1
35	23.1	14.0	15	D/7343-31	T500D156(1)035AG(3)10	5.3	53	6	1000	387	155	39	200	1
35	23.1	14.0	22	D/7343-31	T500D226(1)035AG(3)10	7.7	77	6	700	460	184	46	200	1
35	23.1	14.0	33	X/7343-43	T500X336(1)035(2)G(3)10*	11.6	116	8	600	524	210	52	200	1
50	33.5	20.0	6.8	D/7343-31	T500D685(1)050AG(3)10	3.4	34	6	1000	387	155	39	200	1
50	33.5	20.0	10	D/7343-31	T500D106(1)050AG(3)10	5.0	50	6	1000	387	155	39	200	1

(1) To complete KEMET part number, insert M for ±20% or K for ±10%. Designates capacitance tolerance.

(2) To complete KEMET part number, insert B (0.1%/1,000 hours) or A = N/A. Designates reliability level.

(3) To complete KEMET part number, insert 61 = None, 62 = 10 cycles +25°C after Weibull, 63 = 10 cycles -55°C +85°C after Weibull. Designates surge current option.

* For the part numbers marked with an (*) please consider a 33% derating at +200°C

Refer to Ordering Information for additional detail.

Better than series product may be substituted within the same capacitance and voltage at KEMET's option.

Recommended Voltage Derating Guidelines

Rated Voltage	Working Voltage				Recommended Application Voltage (for maximum reliability)			
	+25°C	+85°C	+125°C	+200°C	25°C	85°C	125°C	200°C
6.3	6.3	6.3	5.0	2.5	3.2	3.2	2.5	1.3
10	10	10	8.0	4.0	5.0	5.0	4.0	2.0
16	16	16	12.8	6.4	8.0	8.0	6.4	3.2
20	20	20	16.0	8.0	10	10	8.0	4.0
25	25	25	20.0	10.0	12.5	12.5	10.0	5.0
35	35	35	28.0	14.0	17.5	17.5	14.0	7.0
50	50	50	40.0	20.0	25.0	25.0	20.0	10.0

Note: Additional reliability can be obtained through the derating of voltage

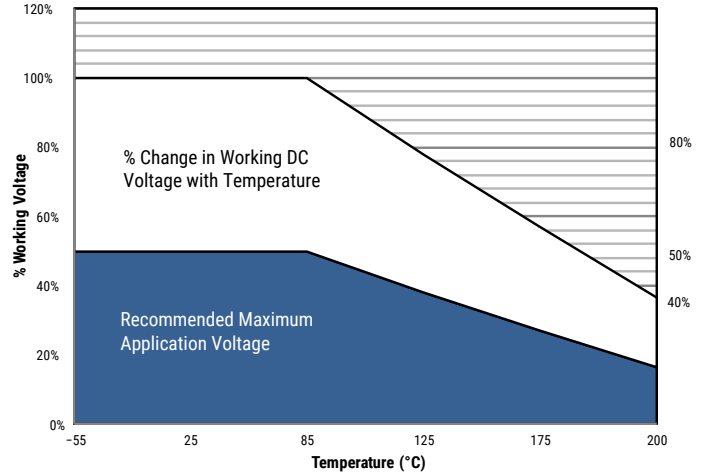

Ripple Current/Ripple Voltage

Permissible AC ripple voltage and current are related to equivalent series resistance (ESR) and the power dissipation capabilities of the device. Permissible AC ripple voltage which may be applied is limited by two criteria:

1. The positive peak AC voltage plus the DC bias voltage, if any, must not exceed the DC voltage rating of the capacitor.
2. The negative peak AC voltage in combination with bias voltage, if any, must not exceed the allowable limits specified for reverse voltage. See the Reverse Voltage section for allowable limits.

The maximum power dissipation by case size can be determined using the table at right. The maximum power dissipation rating stated in the table must be reduced with increasing environmental operating temperatures. Refer to the table below for temperature compensation requirements.

KEMET Case Code	EIA Case Code	Maximum Power Dissipation (P max) mWatts at 25°C with +20°C Rise
B	3528-21	85
C	6032-28	110
D	7343-31	150
X	7343-43	165

The maximum power dissipation rating must be reduced with increasing environmental operating temperatures. Refer to the Temperature Compensation Multiplier table for details.

Using the P max of the device, the maximum allowable rms ripple current or voltage may be determined.

$$I(max) = \sqrt{P_{max}/R}$$

$$E(max) = Z \sqrt{P_{max}/R}$$

I = rms ripple current (amperes)
E = rms ripple voltage (volts)
P max = maximum power dissipation (watts)
R = ESR at specified frequency (ohms)
Z = Impedance at specified frequency (ohms)

Temperature Compensation Multipliers for Maximum Ripple Current					
T ≤ 25°C	T ≤ 85°C	T ≤ 125°C	T ≤ 150°C	T ≤ 175°C	T ≤ 200°C
1.00	0.90	0.40	0.30	0.20	0.10

T = Environmental Temperature

Reverse Voltage

Solid tantalum capacitors are polar devices and may be permanently damaged or destroyed if connected with the wrong polarity. The positive terminal is identified on the capacitor body by a stripe, plus in some cases a beveled edge. A small degree of transient reverse voltage is permissible for short periods per the below table. The capacitors should not be operated continuously in reverse mode, even within these limits.

Temperature	Permissible Transient Reverse Voltage
25°C	15% of Rated Voltage
85°C	5% of Rated Voltage
125°C	1% of Rated Voltage

Table 2 – Land Dimensions/Courtyard

KEMET	Metric Size Code	Density Level A: Maximum (Most) Land Protrusion (mm)					Density Level B: Median (Nominal) Land Protrusion (mm)					Density Level C: Minimum (Least) Land Protrusion (mm)					
		Case	EIA	W	L	S	V1	V2	W	L	S	V1	V2	W	L	S	V1
B	3528-21		2.35	2.21	0.92	6.32	4.00	2.23	1.80	1.12	5.22	3.50	2.13	1.42	1.28	4.36	3.24
C	6032-28		2.35	2.77	2.37	8.92	4.50	2.23	2.37	2.57	7.82	4.00	2.13	1.99	2.73	6.96	3.74
D	7343-31		2.55	2.77	3.67	10.22	5.60	2.43	2.37	3.87	9.12	5.10	2.33	1.99	4.03	8.26	4.84
X ¹	7343-43		2.55	2.77	3.67	10.22	5.60	2.43	2.37	3.87	9.12	5.10	2.33	1.99	4.03	8.26	4.84

Density Level A: For low-density product applications. Recommended for wave solder applications and provides a wider process window for reflow solder processes.

Density Level B: For products with a moderate level of component density. Provides a robust solder attachment condition for reflow solder processes.

Density Level C: For high component density product applications. Before adapting the minimum land pattern variations the user should perform qualification testing based on the conditions outlined in IPC standard 7351 (IPC-7351).

¹ Height of these chips may create problems in wave soldering.

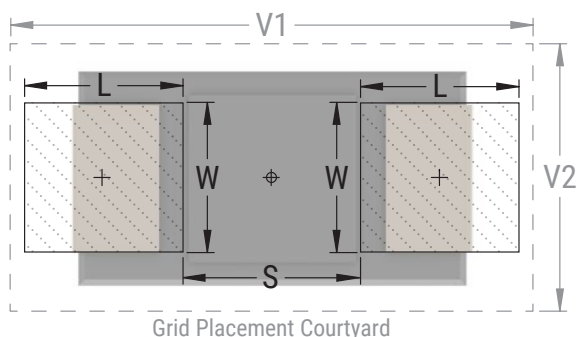

Soldering Process

The KEMET families of surface mount capacitors are compatible with wave (single or dual), convection, IR, or vapor phase reflow techniques. Preheating of these components is recommended to avoid extreme thermal stress. KEMET's recommended profile conditions for convection and IR reflow reflect the profile conditions of the IPC/J-STD-020D standard for moisture sensitivity testing. The devices can safely withstand a maximum of three reflow passes at these conditions.

Please note that although the X/7343-43 case size can withstand wave soldering, the tall profile (4.3 mm maximum) dictates care in wave process development.

Hand soldering should be performed with care due to the difficulty in process control. If performed, care should be taken to avoid contact of the soldering iron to the molded case. The iron should be used to heat the solder pad, applying solder between the pad and the termination, until reflow occurs. Once reflow occurs, the iron should be removed immediately. "Wiping" the edges of a chip and heating the top surface is not recommended.

During typical reflow operations, a slight darkening of the gold-colored epoxy may be observed. This slight darkening is normal and not harmful to the product. Marking permanency is not affected by this change.

Profile Feature	SnPb Assembly	Pb-Free Assembly
Preheat/Soak		
Temperature Minimum (T_{Smin})	100°C	150°C
Temperature Maximum (T_{Smax})	150°C	200°C
Time (t_s) from T_{Smin} to T_{Smax}	60 – 120 seconds	60 – 120 seconds
Ramp-up Rate (T_L to T_P)	3°C/second maximum	3°C/second maximum
Liquidous Temperature (T_L)	183°C	217°C
Time Above Liquidous (t_L)	60 – 150 seconds	60 – 150 seconds
Peak Temperature (T_P)	220°C* 235°C**	250°C* 260°C**
Time within 5°C of Maximum Peak Temperature (t_p)	20 seconds maximum	30 seconds maximum
Ramp-down Rate (T_P to T_L)	6°C/second maximum	6°C/second maximum
Time 25°C to Peak Temperature	6 minutes maximum	8 minutes maximum

Note: All temperatures refer to the center of the package, measured on the package body surface that is facing up during assembly reflow.

* For Case Size height > 2.5 mm

** For Case Size height ≤ 2.5 mm

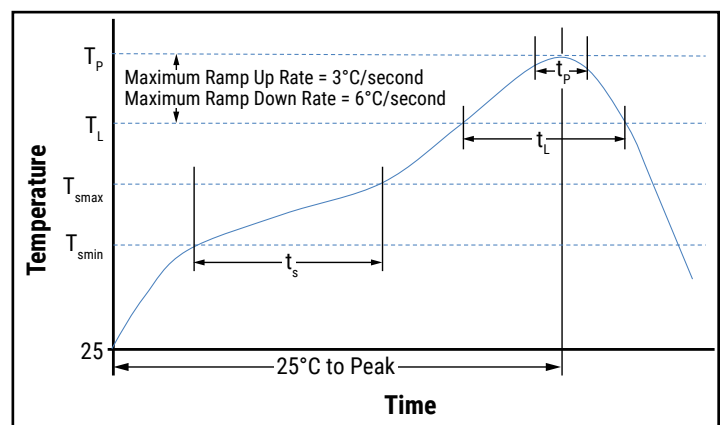

Storage

Tantalum chip capacitors should be stored in normal working environments. While the chips themselves are quite robust in other environments, solderability will be degraded by exposure to high temperatures, high humidity, corrosive atmospheres, and long term storage. In addition, packaging materials will be degraded by high temperature – reels may soften or warp, and tape peel force may increase. KEMET recommends that maximum storage temperature not exceed 40°C and maximum storage humidity not exceed 60% relative humidity. Temperature fluctuations should be minimized to avoid condensation on the parts, and atmospheres should be free of chlorine and sulphur bearing compounds. For optimized solderability, chip stock should be used promptly, preferably within three years of receipt.

Due to the potential use of high melting point solders, KEMET has taken the initiative to package this product in moisture barrier bags with desiccant and a humidity indicator card.

Construction

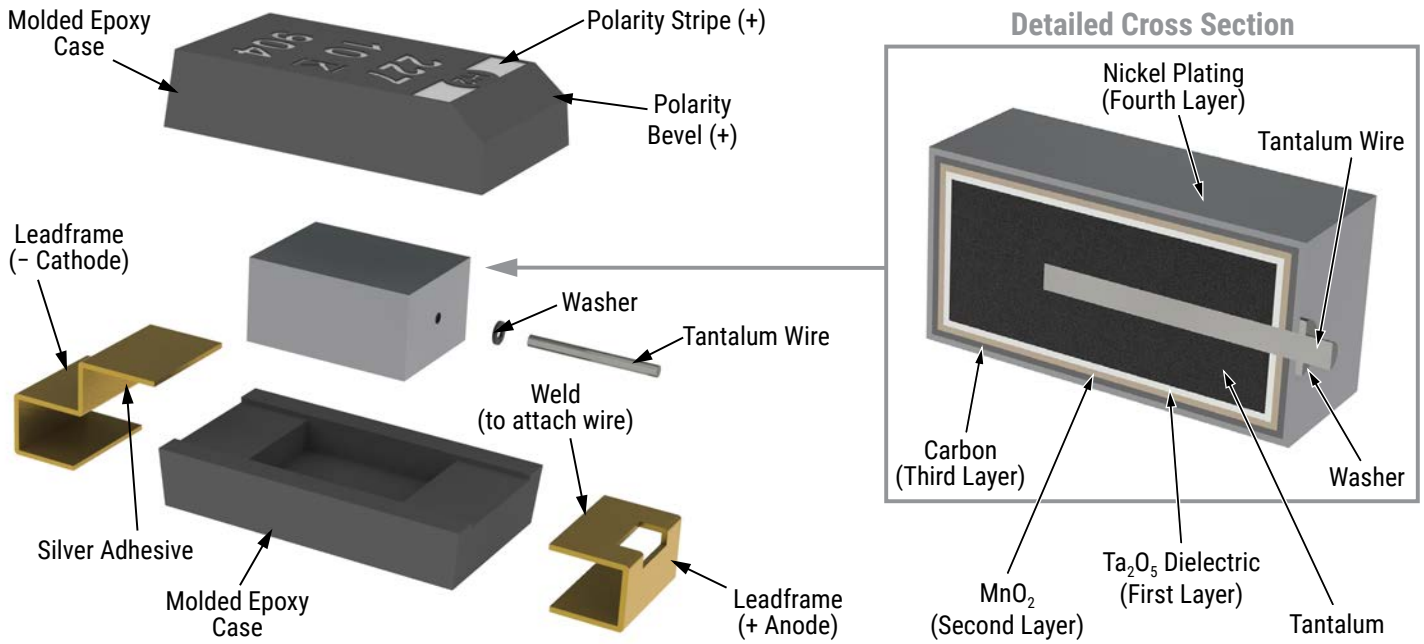

Capacitor Marking

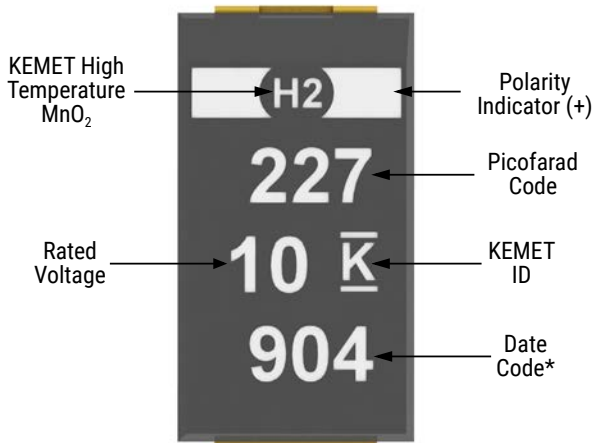

* 904 = 4th week of 2019

Date Code *	
1 st digit = Last number of Year	8 = 2018 9 = 2019 0 = 2020 1 = 2021 2 = 2022 3 = 2023
2 nd and 3 rd digit = Week of the Year	01 = 1 st week of the Year to 52 = 52 nd week of the Year

Tape & Reel Packaging Information

KEMET’s molded chip capacitor families are packaged in 8 and 12 mm plastic tape on 7" and 13" reels in accordance with *EIA Standard 481: Embossed Carrier Taping of Surface Mount Components for Automatic Handling*. This packaging system is compatible with all tape-fed automatic pick-and-place systems.



Table 3 – Packaging Quantity

Case Code		Tape Width (mm)	7" Reel*	13" Reel*
KEMET	EIA			
S	3216-12	8	2,500	10,000
A	3216-18	8	2,000	9,000
T	3528-12	8	3,000	10,000
M	3528-15	8	2,500	8,000
B	3528-21	8	2,000	8,000
U	6032-15	12	1,000	5,000
C	6032-28	12	500	3,000
W	7343-15	12	1,000	3,000
V	7343-20	12	1,000	3,000
D	7343-31	12	500	2,500
X	7343-43	12	500	2,000
E/T428P	7360-38	12	500	2,000

* No C-Spec required for 7" reel packaging. C-7280 required for 13" reel packaging.

Figure 1 – Embossed (Plastic) Carrier Tape Dimensions



Table 4 – Embossed (Plastic) Carrier Tape Dimensions

Metric will govern

Constant Dimensions – Millimeters (Inches)									
Tape Size	D ₀	D ₁ Minimum Note 1	E ₁	P ₀	P ₂	R Reference Note 2	S ₁ Minimum Note 3	T Maximum	T ₁ Maximum
8 mm	1.5 +0.10/-0.0 (0.059 +0.004/-0.0)	1.0 (0.039)	1.75 ±0.10 (0.069 ±0.004)	4.0 ±0.10 (0.157 ±0.004)	2.0 ±0.05 (0.079 ±0.002)	25.0 (0.984)	0.600 (0.024)	0.600 (0.024)	0.100 (0.004)
12 mm		1.5 (0.059)							

Variable Dimensions – Millimeters (Inches)									
Tape Size	Pitch	B ₁ Maximum Note 4	E ₂ Minimum	F	P ₁	T ₂ Maximum	W Maximum	A ₀ , B ₀ & K ₀	
8 mm	Single (4 mm)	4.35 (0.171)	6.25 (0.246)	3.5 ±0.05 (0.138 ±0.002)	2.0 ±0.05 or 4.0 ±0.10 (0.079 ±0.002 or 0.157 ±0.004)	2.5 (0.098)	8.3 (0.327)	Note 5	
12 mm	Single (4 mm) and Double (8 mm)	8.2 (0.323)	10.25 (0.404)	5.5 ±0.05 (0.217 ±0.002)	2.0 ±0.05 (0.079 ±0.002) or 4.0 ±0.10 (0.157 ±0.004) or 8.0 ±0.10 (0.315 ±0.004)	4.6 (0.181)	12.3 (0.484)		

1. The embossment hole location shall be measured from the sprocket hole controlling the location of the embossment. Dimensions of embossment location and hole location shall be applied independent of each other.
2. The tape, with or without components, shall pass around R without damage (see Figure 4).
3. If S₁ < 1.0 mm, there may not be enough area for cover tape to be properly applied (see EIA Standard 481-D, paragraph 4.3, section b).
4. B₁ dimension is a reference dimension for tape feeder clearance only.
5. The cavity defined by A₀, B₀ and K₀ shall surround the component with sufficient clearance that:
 - (a) the component does not protrude above the top surface of the carrier tape.
 - (b) the component can be removed from the cavity in a vertical direction without mechanical restriction, after the top cover tape has been removed.
 - (c) rotation of the component is limited to 20° maximum for 8 and 12 mm tapes (see Figure 2).
 - (d) lateral movement of the component is restricted to 0.5 mm maximum for 8 mm and 12 mm wide tape (see Figure 3).
 - (e) see Addendum in EIA Standard 481-D for standards relating to more precise taping requirements.

Packaging Information Performance Notes

- 1. Cover tape break force:** 1.0 kg minimum.
- 2. Cover tape peel strength:** The total peel strength of the cover tape from the carrier tape shall be:

Tape Width	Peel Strength
8 mm	0.1 to 1.0 newton (10 to 100 gf)
12 mm	0.1 to 1.3 newton (10 to 130 gf)

The direction of the pull shall be opposite the direction of the carrier tape travel. The pull angle of the carrier tape shall be 165° to 180° from the plane of the carrier tape. During peeling, the carrier and/or cover tape shall be pulled at a velocity of 300 ±10 mm/minute.

- 3. Labeling:** Bar code labeling (standard or custom) shall be on the side of the reel opposite the sprocket holes. Refer to EIA Standards 556 and 624.

Figure 2 – Maximum Component Rotation

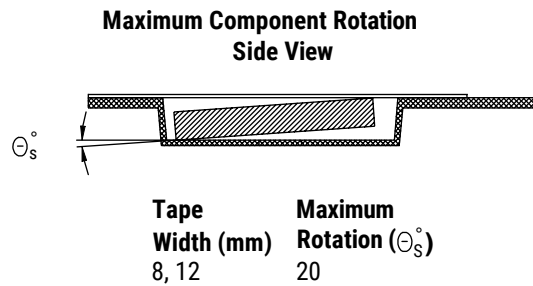
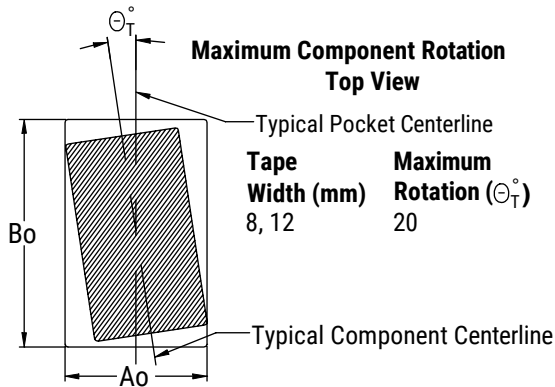

Figure 3 – Maximum Lateral Movement



Figure 4 – Bending Radius



Figure 5 – Reel Dimensions



Note: Drive spokes optional; if used, dimensions B and D shall apply.

Table 5 – Reel Dimensions

Metric will govern

Constant Dimensions – Millimeters (Inches)				
Tape Size	A	B Minimum	C	D Minimum
8 mm	178 ±0.20 (7.008 ±0.008)	1.5 (0.059)	13.0 +0.5/-0.2 (0.521 +0.02/-0.008)	20.2 (0.795)
12 mm	330 ±0.20 (13.000 ±0.008)			
Variable Dimensions – Millimeters (Inches)				
Tape Size	N Minimum	W ₁	W ₂ Maximum	W ₃
8 mm	50 (1.969)	8.4 +1.5/-0.0 (0.331 +0.059/-0.0)	14.4 (0.567)	Shall accommodate tape width without interference
12 mm		12.4 +2.0/-0.0 (0.488 +0.078/-0.0)	18.4 (0.724)	

Figure 6 – Tape Leader & Trailer Dimensions



Figure 7 – Maximum Camber

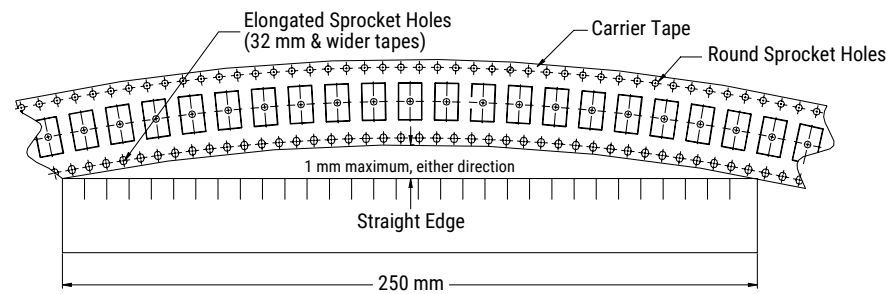

KEMET Electronics Corporation Sales Offices

For a complete list of our global sales offices, please visit www.kemet.com/sales.

Disclaimer

All product specifications, statements, information and data (collectively, the "Information") in this datasheet are subject to change. The customer is responsible for checking and verifying the extent to which the Information contained in this publication is applicable to an order at the time the order is placed. All Information given herein is believed to be accurate and reliable, but it is presented without guarantee, warranty, or responsibility of any kind, expressed or implied.

Statements of suitability for certain applications are based on KEMET Electronics Corporation's ("KEMET") knowledge of typical operating conditions for such applications, but are not intended to constitute – and KEMET specifically disclaims – any warranty concerning suitability for a specific customer application or use. The Information is intended for use only by customers who have the requisite experience and capability to determine the correct products for their application. Any technical advice inferred from this Information or otherwise provided by KEMET with reference to the use of KEMET's products is given gratis, and KEMET assumes no obligation or liability for the advice given or results obtained.

Although KEMET designs and manufactures its products to the most stringent quality and safety standards, given the current state of the art, isolated component failures may still occur. Accordingly, customer applications which require a high degree of reliability or safety should employ suitable designs or other safeguards (such as installation of protective circuitry or redundancies) in order to ensure that the failure of an electrical component does not result in a risk of personal injury or property damage.

Although all product-related warnings, cautions and notes must be observed, the customer should not assume that all safety measures are indicated or that other measures may not be required.

KEMET is a registered trademark of KEMET Electronics Corporation.