

# SINGLE TURN CERMET TRIMMERS

# RJ-6

RoHS compliant

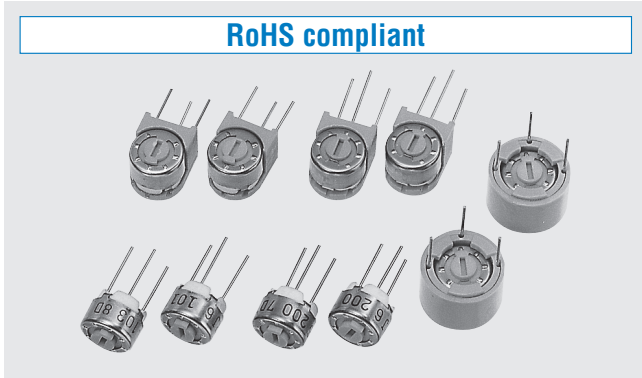

## FEATURES

- RoHS compliant
- Wide resistance range from 10  $\Omega$  to 5 M  $\Omega$
- Low contact resistance variation (1 % maximum)
- Precious metal alloy wiper

## INTERNAL STRUCTURE

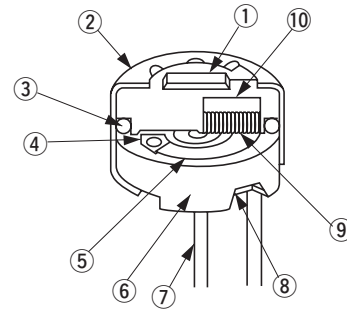

	Part name	Material	Flammability
①	Rotor	Polybutyleneterephthalate	UL94HB
②	Cover	Stainless steel	—
③	“O” ring	Silicone rubber	UL94HB
④	Electrode	Ag-Pd cermet	—
⑤	Resistive element	RuO <sub>2</sub> cermet	
⑥	Base element	Ceramic	
⑦	Terminal pin	Nickel, Gold-plated	
⑧	Adhesive	Epoxy	
⑨	Wiper	Multi metal alloy	
⑩	Rubber cushion	Silicone rubber	





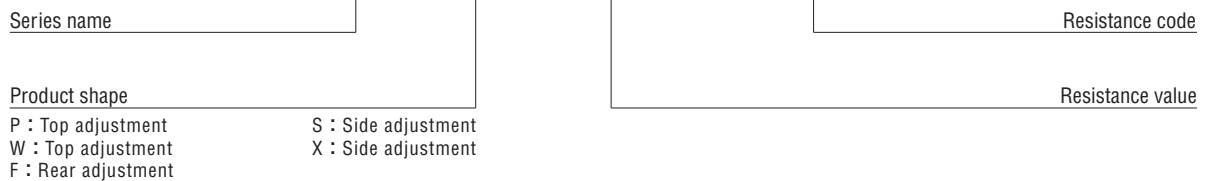

## PART NUMBER DESIGNATION

R J - 6 P 1 0 k  $\Omega$  ( 1 0 3 )



※ Please refer to the LIST OF PART NUMBERS when placing orders.

## LIST OF PART NUMBERS

Adjustment position	Shape of terminal (Top view)	Form of packaging	Pieces in package
		Plastic bag	
Top adjustment 		RJ-6P	50 pcs./pack
		RJ-6W	
Side adjustment (↑ Adjustment direction)		RJ-6S	
		RJ-6X	
Rear adjustment		 RJ-6F	

## ELECTRICAL CHARACTERISTICS

Nominal resistance range	10 Ω ~ 5 MΩ
Resistance tolerance	± 10 %
Power ratings	0.5 W (70 °C) 0 W (120 °C)
Resistance law	(B) Linear law
Maximum input voltage	DC200 V or power rating, whichever is smaller
Maximum wiper current	100 mA or power rating, whichever is smaller
Effective electrical angle	230 ° (1 turn)
End resistance	1 % or 2 Ω, whichever is greater
C.R.V.	1 % or 3 Ω, whichever is greater
Operating temp. range	− 55 ~ 120 °C
Temp. coefficient	10 Ω, 20Ω, 5 MΩ : ± 250 10 <sup>-6</sup> /°C maximum 50 Ω ~ 2 MΩ : ± 100 10 <sup>-6</sup> /°C maximum
Insulation resistance	1000 MΩ minimum (DC500 V)
Dielectric strength	AC900 V, 60 s
Net weight	Approx. 0.60 g (RJ-6P,W) Approx. 0.80 g (RJ-6S, X) Approx. 1.01 g (RJ-6F)

## <Nominal resistance values>





 10 Ω	 20 Ω	50 Ω	100 Ω	200 Ω	500 Ω	1 k Ω	2 k Ω	5 k Ω	10 k Ω
20 k Ω	 25 k Ω	50 k Ω	100 k Ω	200 k Ω	 250 k Ω	500 k Ω	1 M Ω	2 M Ω	 5 M Ω

Fig. 1

\* The above part numbers are all available with the respective combination of <Nominal resistance values> (Fig. 1).

\* Verify the above part numbers when placing orders.

**The products indicated by  mark are manufactured upon receipt of order basis.**

## MECHANICAL CHARACTERISTICS

Mechanical angle	270 ° (1 turn)
Operating torque	2~ 15 mN·m {20 ~ 153 gf·cm}
Stop strength	50 mN·m {510 gf·cm} minimum
Rotational life	200 cycles 10 Ω ~ 200 Ω [ Δ R/R ≤ ± (0.5 Ω + 3 %) ] 500 Ω ~ 5 MΩ [ Δ R/R ≤ ± (0.5 Ω + 2 %) ]
Terminal to strength	10 N {1.02 kgf} minimum (Tensile strength)
Thrust rotor	10 N {1.02 kgf} minimum
Solderability	245 ± 3 °C, 2 ~ 3 s

{ } : Reference only

## ENVIRONMENTAL CHARACTERISTICS

Test item	Test conditions	Specifications
Thermal shock	− 65 ~ 125 °C (0.5 h), 5 cycles	[ Δ R/R ≤ 1 % ] [ S.S. ≤ 1 % ]
Humidity	− 10 ~ 65 °C (80 ~ 98 %), 10 cycles, 240 h	[ Δ R/R ≤ 1 % ]
Shock	981 m/s <sup>2</sup> , 6 ms 6 directions for 3 times each	[ Δ R/R ≤ 1 % ] [ S.S. ≤ 1 % ]
Vibration	(Amplitude) 1.52 mm or (Acceleration) 196 m/s <sup>2</sup> ; 10 ~ 2000 Hz, 3 directions, 12 times each	
Load life	70 °C, 0.5 W, 1000 h	[ Δ R/R ≤ 2 % ] [ S.S. ≤ 1 % ]
Low temp. operation	− 55 °C, 2 h	[ Δ R/R ≤ 1 % ] [ S.S. ≤ 2 % ]
High temp. exposure	120 °C, 250 h	[ Δ R/R ≤ 2 % ] [ S.S. ≤ 2 % ]
Immersion seal	85 °C, 60 s	No leaks (No continuous bubbles)
Soldering heat	Flow 260 ± 3 °C, 5 ~ 6 s, two times maximum	[ Δ R/R ≤ 1 % ]
	Manual soldering 380 ± 10 °C, 3 ~ 4 s	

Δ R/R : Change in total resistance  
S.S. : Setting stability

# RJ-6

## CERMET TRIMMERS

### MAXIMUM INPUT RATINGS

Nominal resistance values (Ω)	Resistance code	Maximum input voltage (V)	Maximum wiper current (mA)
<ul style="list-style-type: none"> <li>↷ 10</li> <li>↷ 20</li> <li>50</li> <li>100</li> <li>200</li> <li>500</li> </ul>	<ul style="list-style-type: none"> <li>100</li> <li>200</li> <li>500</li> <li>101</li> <li>201</li> <li>501</li> </ul>	<ul style="list-style-type: none"> <li>1.00</li> <li>2.00</li> <li>5.00</li> <li>7.07</li> <li>10.0</li> <li>15.8</li> </ul>	<ul style="list-style-type: none"> <li>100</li> <li>100</li> <li>100</li> <li>70.7</li> <li>50.0</li> <li>31.6</li> </ul>
<ul style="list-style-type: none"> <li>1 k</li> <li>2 k</li> <li>5 k</li> <li>10 k</li> <li>20 k</li> <li>↷ 25 k</li> <li>50 k</li> </ul>	<ul style="list-style-type: none"> <li>102</li> <li>202</li> <li>502</li> <li>103</li> <li>203</li> <li>253</li> <li>503</li> </ul>	<ul style="list-style-type: none"> <li>22.4</li> <li>31.6</li> <li>50.0</li> <li>70.7</li> <li>100</li> <li>112</li> <li>158</li> </ul>	<ul style="list-style-type: none"> <li>22.4</li> <li>15.8</li> <li>10.0</li> <li>7.07</li> <li>5.00</li> <li>4.48</li> <li>3.16</li> </ul>
<ul style="list-style-type: none"> <li>100 k</li> <li>200 k</li> <li>↷ 250 k</li> <li>500 k</li> <li>1 M</li> <li>2 M</li> <li>↷ 5 M</li> </ul>	<ul style="list-style-type: none"> <li>104</li> <li>204</li> <li>254</li> <li>504</li> <li>105</li> <li>205</li> <li>505</li> </ul>	<ul style="list-style-type: none"> <li>200</li> <li>200</li> <li>200</li> <li>200</li> <li>200</li> <li>200</li> <li>200</li> </ul>	<ul style="list-style-type: none"> <li>2.00</li> <li>1.00</li> <li>0.80</li> <li>0.40</li> <li>0.20</li> <li>0.10</li> <li>0.04</li> </ul>

The products indicated by ↷ mark are manufactured upon receipt of order basis.

### OUTLINE DIMENSIONS

Unless otherwise specified, tolerance: ± 0.3 (Unit: mm)

#### RJ-6P Top adjustment

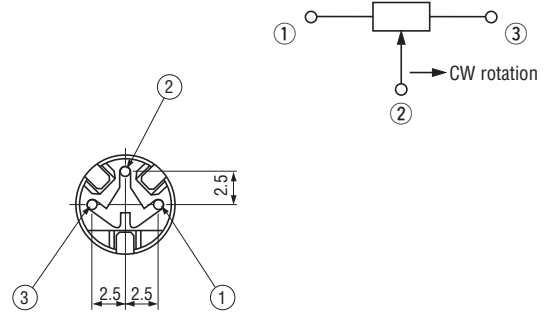
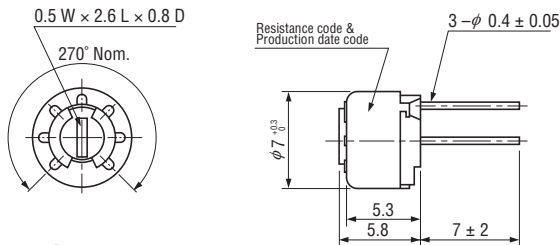

#### RJ-6W Top adjustment

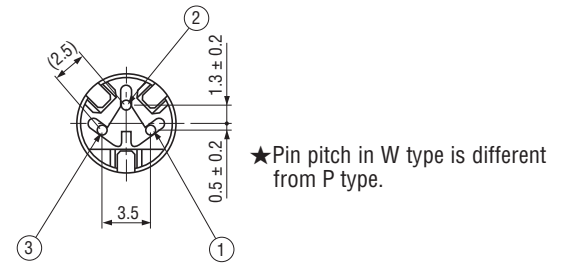
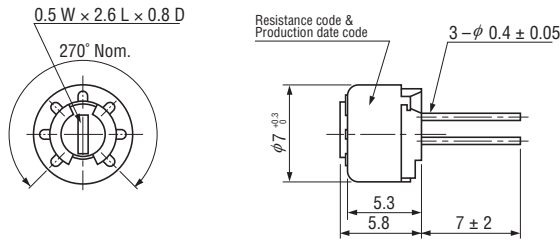

★ Pin pitch in W type is different from P type.

#### RJ-6S Side adjustment

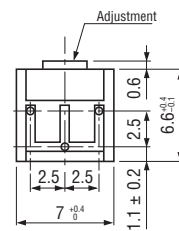
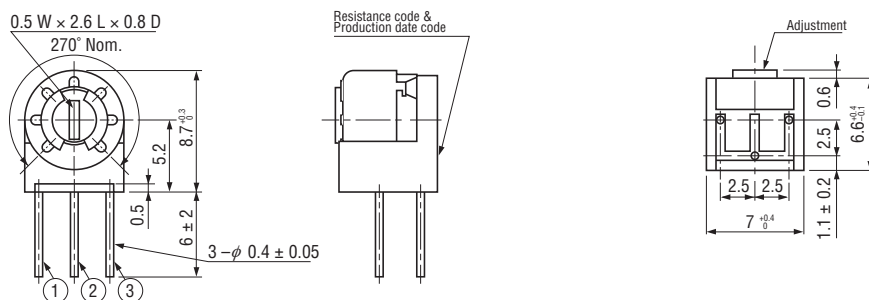

### OUTLINE DIMENSIONS

#### RJ-6X Side adjustment

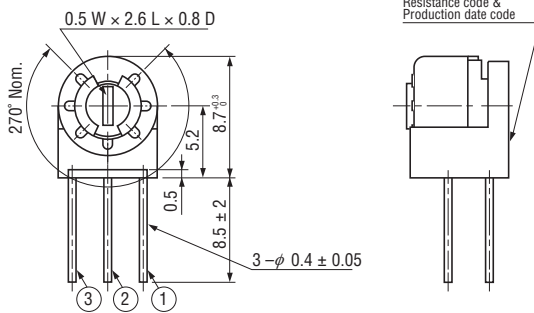

Unless otherwise specified, tolerance: ± 0.3 (Unit: mm)

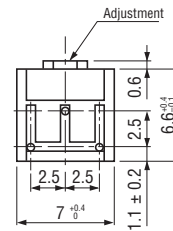
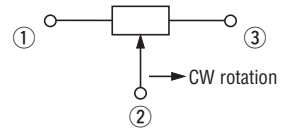

★ Pin position & stopper position of X type are different from S type.

#### RJ-6F Rear adjustment

< Semi-standard products >

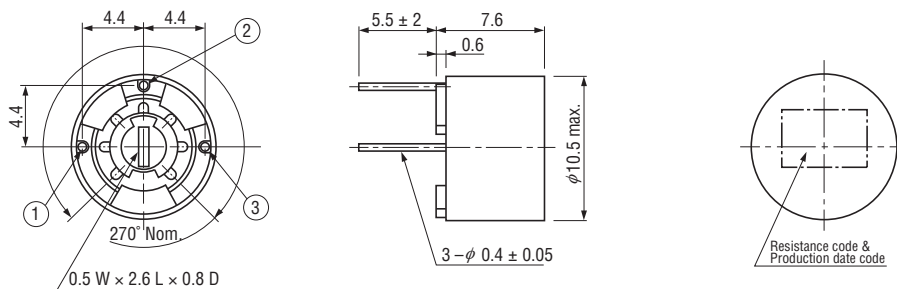

### PACKAGING SPECIFICATIONS

#### <Bulk pack specifications>

- Unit of bulk pack in a plastic bag is 50 pcs. per pack.
- Boxing of bulk in a plastic bag is performed with 200 pcs. (RJ-6F is 100 pcs.) per box.