

6

5

4

3

2

1

APPROVED: _____
DATE: _____ TITLE: _____

Rev	AWO #	Description	Date	Appr
-		RELEASED	8/16/21	

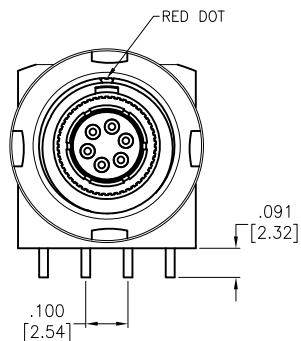
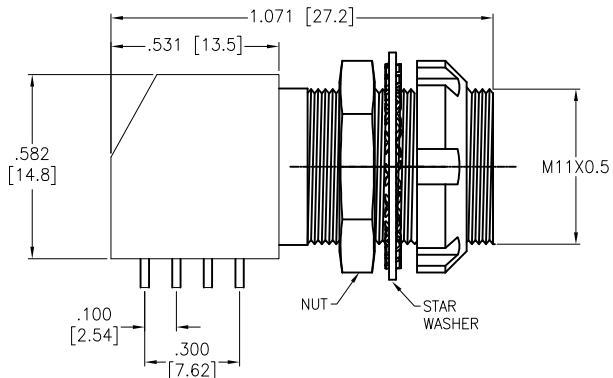

MMI-ES1GXXPR-T

OF POSITIONS
(02, 03, 04, 05, 06, 07, 08 & 10)

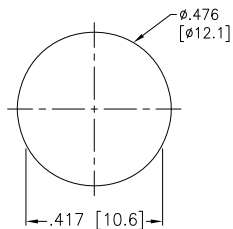
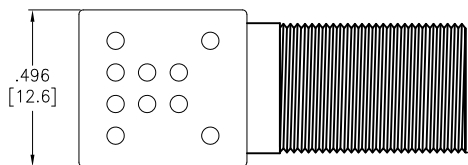

Panel Cut-Out
(Rear Panel Mounting)

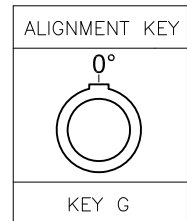

	2 Pin	3 Pin	4 Pin	5 Pin	6 Pin	7 Pin	8 Pin	10 Pin
Configuration								
Testing Voltage	1700V	1700V	1600V	1300V	1350V	1450V	1300V	1000V
Working Voltage	300V	300V	250V	250V	200V	200V	200V	200V
Rated Current / Pin	4.5A	4.5A	4.5A	4.5A	4.5A	2A	2A	1.5A

SPECIFICATIONS:

Material:
 Insulator: (PPS) Hi-temp thermoplastic, rated UL 94V-0
 Insulator color: Black
 Contacts: Brass, Gold plated
 Shell: Brass
 Electrical:
 Voltage Rating: See chart
 Current Rating: See chart
 Dielectric withstanding voltage: See chart
 Electrical Life: 1,000 Cycles min.
 Mechanical:
 Endurance: 5,000 Cycles Min.
 Temperature Rating:
 Operating temperature: -55°C to +150°C
 Environmental:
 IP50 Protection (Mated Condition)
 Lead free, RoHS compliant



UNLESS OTHERWISE SPECIFIED
 ALL DIMENSIONS ARE INCHES [MM]
 TOLERANCES: EXCEPT AS NOTED

INCHES		HOLES	
.X	± .10	Ø.X	± .10
.XX	± .020	Ø.XX	± .015
.XXX	± .015	Ø.XXX	± .010



909 Rahway Avenue,
 Union, NJ 07083
 Phone: 908-687-5000
 Fax: 908-687-5710

APPROVALS		DATE
DRAWN	SS	8/16/21
CHECKED	SS	8/16/21
APPROVED		

TITLE
 PUSH-PULL ELBOW SOCKET, RIGHT ANGLE, SIZE 1,
 PCB MOUNT, THREADED BUSHING, IP50

SIZE X	PART NO. MMI-ES1GXXPR-T	REV. -
REF: SXXXXX	SCALE: NTS	SHEET 1 OF 2

6

5

4

3

2

1

APPROVED: _____
 DATE: _____ TITLE: _____

Rev	AWO #	Description	Date	Appr
-		RELEASED	8/16/21	

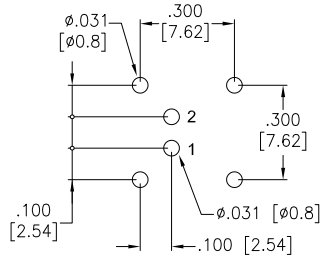

2 PIN

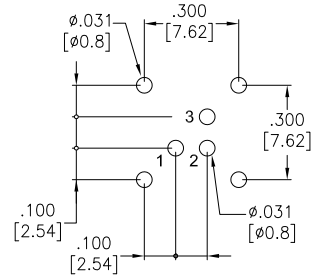

3 PIN

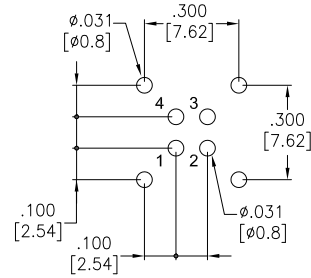

4 PIN

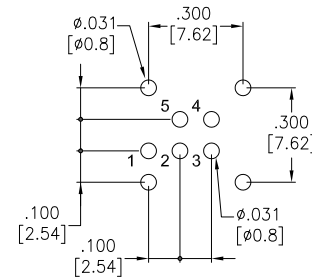

5 PIN

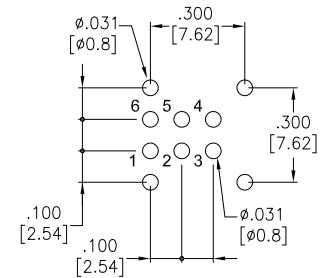

6 PIN

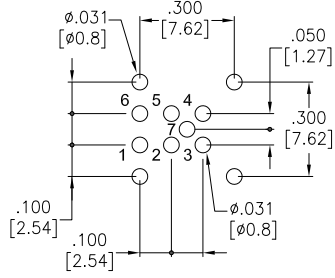

7 PIN

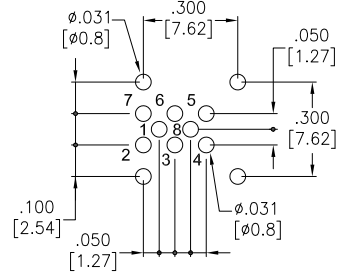

8 PIN

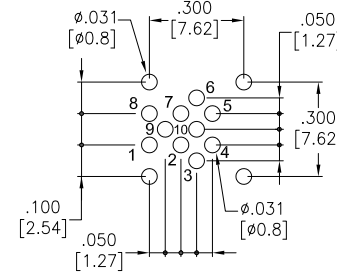

10 PIN

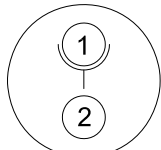

2 PIN

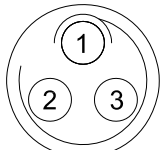

3 PIN

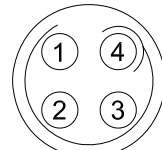

4 PIN

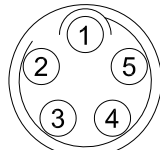

5 PIN

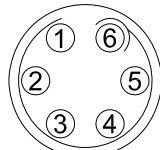

6 PIN

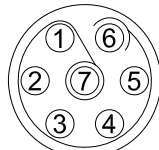

7 PIN

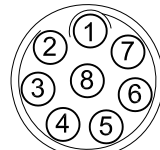

8 PIN

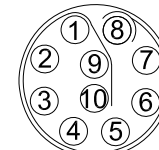

10 PIN

UNLESS OTHERWISE SPECIFIED
 ALL DIMENSIONS ARE INCHES [MM]
 TOLERANCES: EXCEPT AS NOTED

.X	± .10	∅X	± .10
.XX	± .020	∅.XX	± .015
.XXX	± .015	∅.XXX	± .010

APPROVALS		DATE
DRAWN	SS	8/16/21
CHECKED	SS	8/16/21
APPROVED		

ADAM TECH 909 Rahway Avenue,
 Union, NJ 07083
 Phone: 908-687-5000
 Fax: 908-687-5710

TITLE: PUSH-PULL ELBOW SOCKET, RIGHT ANGLE, SIZE 1,
 PCB MOUNT, THREADED BUSHING, IP50

SIZE X	PART NO. MMI-ES1GXXPR-T	REV. -
REF: SXXXXX	SCALE: NTS	SHEET 2 OF 2