

Data sheet | Item number: 890-225

Socket; 5-pole; Cod. A; 1,50 mm²; white

www.wago.com/890-225

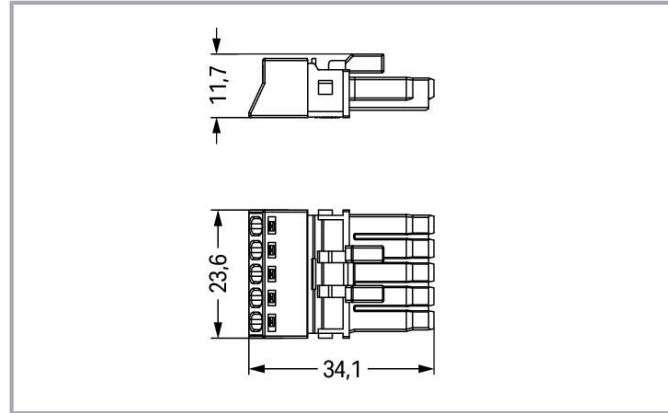
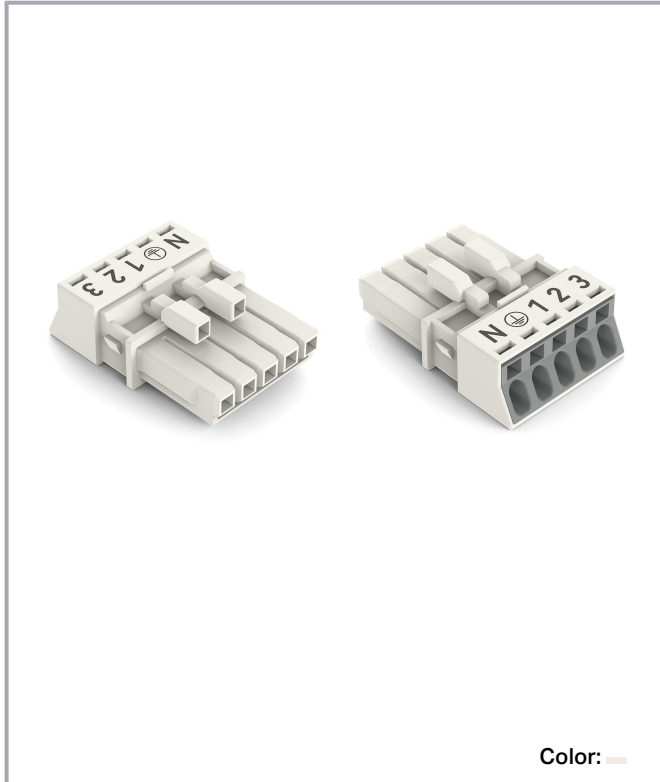

Item description

Female connector/socket *WINSTA*® MINI with protection against mismatching

The *WINSTA*® MINI female connector/socket A coding is the pluggable solution for your application in control cabinets, on PCBs or for lighting connections. On PCBs, in control cabinets or for connecting lights – pluggable installation connectors from WAGO allow you to make connections according to many different requirements in seconds. The coding options reduce installation errors, allowing fast, secure wiring of all components. General mains applications for almost any domain of use can be realised with *WINSTA*® MINI pluggable installation connectors with A coding. If only limited space is available, our smallest pluggable connection system, *WINSTA*® MINI, conveniently displays its advantages. It saves space, and, thanks to Push-in CAGE CLAMP® spring pressure connection technology, it also saves time, since the installation is low-maintenance and requires no screw connections.

Lower costs through fast commissioning and elimination of service expenses – solutions from *WINSTA*® MINI

Subject to changes. Please also observe the further product documentation!

WAGO GmbH & Co. KG
Hansastr. 27
32423 Minden
Phone: +49571 887-0 | Fax: +49571 887-169
Email: info.de@wago.com | Web: www.wago.com

Do you have any questions about our products?
We are always happy to take your call at +49 (571) 887-44222.



The WINSTA® Pluggable Connection System allows pluggable electrical installation. This saves time, lowers costs, and reduces the need for servicing. Choose quality and durability – the WINSTA® MINI pluggable installation connector with protection type IP20 from WAGO makes the electrical installation of electrical components significantly easier.

- effective protection against mismatching
- easy tool-free operation, a wide range of coding options
- for any mains application
- custom-engineered solutions
- rapid, structured electrical installation

Data

Electrical data

Ratings per IEC/EN

Ratings per	IEC/EN 60664-1
Nominal voltage (III/3)	400 V
Rated impulse voltage (III/3)	6 kV
Rated current	13 A
Legend (ratings)	(III / 3) ≙ Overvoltage category III / Pollution degree 3

Ratings per UL 1977

Note for the US market	Some versions may also be used for current interruption in accordance with the UL certificate in select applications with currents below 5 A and voltages up to 600 V. For further information, please contact your local sales office.
Rated voltage (UL 1977)	600 V
Rated current UL 1977	12 A

General

Note on contact resistance	approx. 1 mΩ of contact resistance approx. 0.25 mΩ contact transition plug/socket
----------------------------	--

Connection data

Connection points	5
Total number of potentials	5

Subject to changes. Please also observe the further product documentation!



Connection 1

Connection technology	Push-in CAGE CLAMP®
Actuation type	Operating tool Push-in
Nominal cross-section	1.5 mm ² / 16 AWG
Solid conductor	0.25 ... 1.5 mm ² / 22 ... 16 AWG
Solid conductor; push-in termination	0.75 ... 1.5 mm ² / 20 ... 16 AWG
Stranded conductor	0.25 ... 1 mm ² / 22 ... 18 AWG
Fine-stranded conductor	0.25 ... 1.5 mm ² / 22 ... 16 AWG
Fine-stranded conductor; with insulated ferrule	0.25 ... 0.75 mm ² / 22 ... 20 AWG
Fine-stranded conductor; with uninsulated ferrule	0.25 ... 0.75 mm ² / 22 ... 20 AWG
Fine-stranded conductor; with ferrule; push-in termination	0.75 mm ² / 20 AWG
Strip length	9 mm / 0.35 inches
Pole number	5
Conductor entry direction to mating direction	0°

Physical data

Pin spacing	4.4 mm / 0.173 inches
Width	23.6 mm / 0.929 inches
Height	11.7 mm / 0.461 inches
Depth	34.1 mm / 1.343 inches

Mechanical Data

Application	General mains applications
Coding	A
Variable coding	No
Marking	N $\frac{1}{2}$ 1 2 3
Potential marking	N $\frac{1}{2}$ 1 2 3
Mating force of a plug-in connection	approx. 20 ... 70 N (depending on pole number)
Retention force of a plug-in connection	Locked: > 80 N
Unmating force of a plug-in connection	Unlocked: approx. 20 ... 70 N (depending on pole number)
Number of mating cycles	200, without resistive load
Protection type	IP20; IP40 with strain relief housing

Subject to changes. Please also observe the further product documentation!



Plug-in connection

Contact type (pluggable connector)	Female connector/socket
Connector (connection type)	for conductor
Mismating protection	Yes
Note on mismating protection	All <i>WINSTA</i> [®] components are 100% protected against mismating when: a.) plugging different numbers of poles b.) plugging while rotated 180 c.) plugging while laterally staggered d.) plugging one pole
Locking lever	Can be retrofitted
Locking of plug-in connection	locking lever
Note on locking system	All connectors for mounted installations (snap-in versions for lighting fixtures or devices, all types of PCB and distribution connectors) are factory-equipped with locking levers to ensure plugs and sockets are securely locked. Additional locking levers are only required for flying leads (plug/socket).

Material Data

Note (material data)	Information on material specifications can be found here
Color	white
Cover color	gray
Material group	I
Insulation material	Polyamide (PA66)
Flammability class per UL94	V0
Clamping spring material	Chrome-nickel spring steel (CrNi)
Contact material	Copper or copper alloy; surface-treated
Contact plating	Tin
Fire load	0.152 MJ
Weight	6 g

Environmental requirements

Processing temperature	-5 ... +40 °C
Continuous operating temperature	-35 ... +85 °C
Note on continuous operating temperature	Insulating parts for temperatures ≤ 105 °C

Subject to changes. Please also observe the further product documentation!

WAGO GmbH & Co. KG
Hansastr. 27
32423 Minden
Phone: +49571 887-0 | Fax: +49571 887-169
Email: info.de@wago.com | Web: www.wago.com

Do you have any questions about our products?
We are always happy to take your call at +49 (571) 887-44222.

Commercial data



Product Group	20 (Winsta)
eCl@ss 10.0	27-44-06-05
eCl@ss 9.0	27-44-06-05
ETIM 8.0	EC002560
ETIM 7.0	EC002560
PU (SPU)	50 pcs
Packaging type	box
Country of origin	DE
GTIN	4045454233204
Customs tariff number	85366990990

Environmental Product Compliance

RoHS Compliance Status	Compliant, No Exemption
------------------------	-------------------------

Approvals / Certificates

General approvals

Logo	Approval	Additional Approval Text	Certificate name
	CCA DEKRA Certification B.V.	EN 61535	71- 123231
	CCA DEKRA Certification B.V.	IEC 61535	NL-85020
	cURus Underwriters Laboratories Inc.	UL 1977	E45171

Declarations of conformity and manufacturer's declarations

Logo	Approval	Additional Approval Text	Certificate name
	EU-Declaration of Conformity WAGO GmbH & Co. KG	-	-
	UK-Declaration of Conformity WAGO GmbH & Co. KG	-	-



Subject to changes. Please also observe the further product documentation!

WAGO GmbH & Co. KG
 Hansastr. 27
 32423 Minden
 Phone: +49571 887-0 | Fax: +49571 887-169
 Email: info.de@wago.com | Web: www.wago.com







Do you have any questions about our products?
 We are always happy to take your call at +49 (571) 887-44222.



Approvals for marine applications

Logo	Approval	Additional Approval Text	Certificate name
	ABS American Bureau of Shipping	Steel Vessel Rules	19- HG1869855- PDA
	DNV GL Det Norske Veritas, Germanischer Lloyd	-	TAE00001Z6
	LR Lloyds Register	EN 61535	08/20047 (E2)

Counterpart

	Item no.890-135 Plug; with strain relief housing; 5-pole; 1,50 mm ² ; white	www.wago.com/890-135
	Item no.890-235 Plug; 5-pole; Cod. A; 1,50 mm ² ; white	www.wago.com/890-235
	Item no.890-671 T-distribution connector; 5-pole; Cod. A; 1 input; 2 outputs; 2 locking levers; white	www.wago.com/890-671
	Item no.890-672 T-distribution connector; 5-pole; Cod. A; 1 input; 2 outputs; 3 locking levers; for flying leads; white	www.wago.com/890-672
	Item no.890-735 Snap-in plug; 5-pole; Cod. A; 1,50 mm ² ; white	www.wago.com/890-735
	Item no.890-835 Plug for PCBs; straight; 5-pole; Cod. A; white	www.wago.com/890-835
	Item no.890-835/011-000 Plug for PCBs; angled; 5-pole; Cod. A; white	www.wago.com/890-835/011-000

Subject to changes. Please also observe the further product documentation!



Item no. 890-979

h-distribution connector; 5-pole; Cod. A; 1 input; 2 outputs; outputs on one side; 2 locking levers; white

www.wago.com/890-979



Item no. 890-980

h-distribution connector; 5-pole; Cod. A; 1 input; 2 outputs; outputs on one side; 3 locking levers; for flying leads; white

www.wago.com/890-980



Item no. 891-8995/006-102

pre-assembled interconnecting cable; Eca; Socket/plug; 5-pole; Cod. A; H05VV-F 5G 1.5 mm²; 1 m; 1,50 mm²; white

www.wago.com/891-8995/006-102



Item no. 891-8995/206-102

pre-assembled connecting cable; Eca; Plug/open-ended; 5-pole; Cod. A; H05VV-F 5G 1.5 mm²; 1 m; 1,50 mm²; white

www.wago.com/891-8995/206-102

Required accessories

Strain relief

Strain relief housing



Item no.: 890-505

Strain relief housing; 5-pole; with locking clip; for 1 cable; 6.5 ... 10.5 mm; 45 mm; black

www.wago.com/890-505



Item no.: 890-515

Strain relief housing; 5-pole; with locking clip; for 1 cable; 6.5 ... 10.5 mm; 45 mm; white

www.wago.com/890-515

Locking levers

Locking system



Item no.: 890-111

Locking lever; for flying leads; for tool operation; black

www.wago.com/890-111



Item no.: 890-101

Locking lever; for manual operation; black

www.wago.com/890-101



Item no.: 890-121

Locking lever; for manual operation; white

www.wago.com/890-121



Item no.: 890-131

Locking lever; for flying leads; for tool operation; white

www.wago.com/890-131

Optional accessories

Cover

Subject to changes. Please also observe the further product documentation!

WAGO GmbH & Co. KG

Hansastr. 27

32423 Minden

Phone: +49571 887-0 | Fax: +49571 887-169

Email: info.de@wago.com | Web: www.wago.com

Do you have any questions about our products?

We are always happy to take your call at +49 (571) 887-44222.

Cover



Item no.: 897-2003
Protective cap; Type2; for sockets and plugs; PVC; red

www.wago.com/897-2003

Tool

Operating tool



Item no.: 210-719
Operating tool; Blade: 2.5 x 0.4 mm; with a partially insulated shaft

www.wago.com/210-719



Item no.: 890-385
Operating tool; 5-way; green

www.wago.com/890-385

Shield termination

Shield termination



Item no.: 890-526
Shield connecting plate; 5-pole; for sockets

www.wago.com/890-526

Mounting

Mounting accessories



Item no.: 890-310
Mounting carrier; 2- to 5-pole; for flying leads; black

www.wago.com/890-310



Item no.: 890-311
Mounting carrier; 2- to 5-pole; for flying leads; white

www.wago.com/890-311

Downloads

Documentation

Bid Text

890-225 X81 - Datei	2019 Feb 19	xml 3.0 kB	Download
890-225 doc - Datei	2015 Jun 8	doc 23.6 kB	Download

CAD/CAE-Data

CAD data

Subject to changes. Please also observe the further product documentation!

WAGO GmbH & Co. KG
Hansastr. 27
32423 Minden
Phone: +49571 887-0 | Fax: +49571 887-169
Email: info.de@wago.com | Web: www.wago.com

Do you have any questions about our products?
We are always happy to take your call at +49 (571) 887-44222.

2D/3D Models 890-225

[URL](#)

[Download](#)

CAE data

WSCAD Universe 890-225

[URL](#)

[Download](#)

ZUKEN Portal 890-225

[URL](#)

[Download](#)

Environmental Product Compliance

Compliance Search

Environmental Product Compliance 890-225

[URL](#)

[Download](#)

Socket; 5-pole; Cod. A; 1,50 mm²; white

Installation Notes

Conductor termination

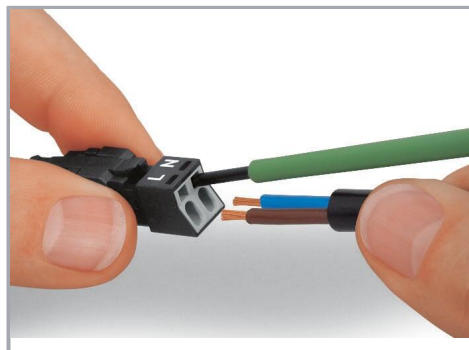
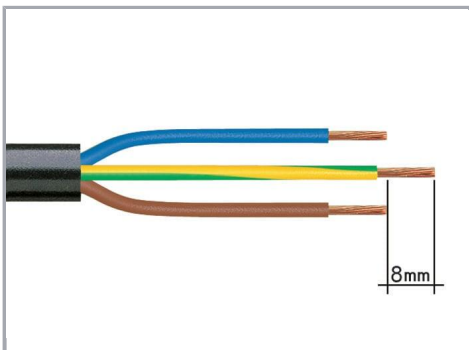

1. Strip length, outer insulation = 30 mm (2-pole), 37 mm (3-pole), 45 mm (4- and 5-pole)

2. Strip length = 9 mm

3. Extended ground conductor = 8 mm

To terminate fine-stranded conductors, open the clamping unit via screwdriver – 2.5 mm blade width – and insert a stripped conductor until it hits the backstop. Terminate solid conductors by simply pushing them in.

Subject to changes. Please also observe the further product documentation!

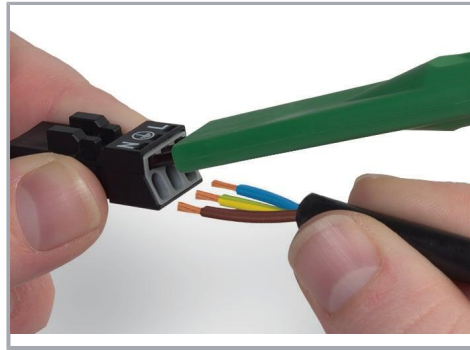
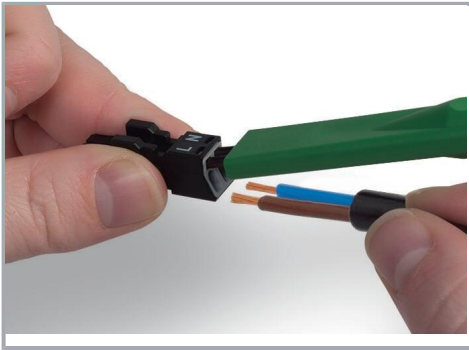

To terminate fine-stranded conductors, open clamping units via operating tool (890-382) and insert stripped conductors until they hit backstop.

To terminate fine-stranded conductors, open clamping units via operating tool (890-383) and insert stripped conductors until they hit backstop.

Terminate solid conductors by simply pushing them in.

Terminate solid conductors by simply pushing them in.

Installation

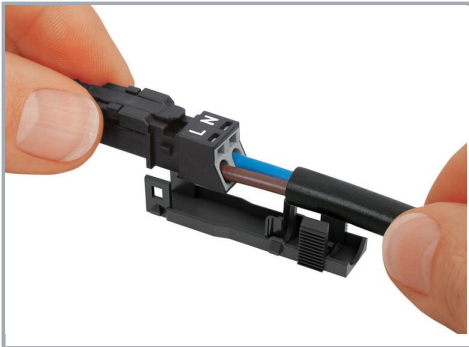

Latch the wired connector into the base of the strain relief housing.

Push down strain relief clamp by hand.

Subject to changes. Please also observe the further product documentation!



Push down strain relief clamp with 2.5 mm screwdriver alternately on both sides.

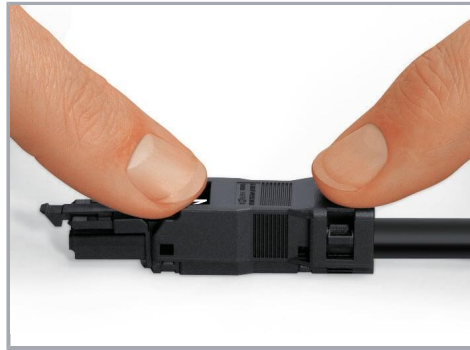

Latch the top of the strain relief housing.



The printed marking of the connector is clearly visible in the openings of the strain relief housing.

Shield termination



Connector with shield termination

Subject to changes. Please also observe the further product documentation!



Apply the shield to the sheathed cable.

Strip length, outer insulation = 30 mm

Shield length = 8 mm



Push the shield connecting plate into the connector until fully inserted.

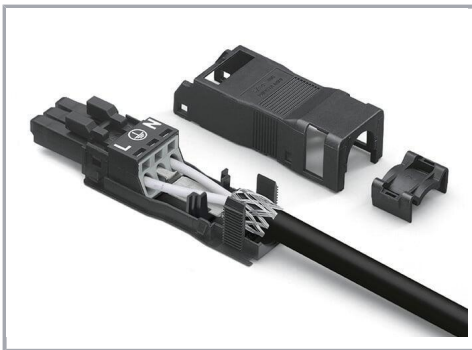

First insert the wired connector into strain relief housing, then snap clamp and cover.

Product family

WINSTA® MINI

[Show all products from the family](#)

Subject to changes. Please also observe the further product documentation!