



American Opto Plus LED Corp.

CTD-IC591B-W/W

**15.0 x 15.0 x 11.0 mm Blue Touch LED Display w/
Touch Drive IC**

- ◆ Low Power Consumption
- ◆ RoHS compliant
- ◆ Case mold type
- ◆ Easy Mounting on PC board / socket

MECHANICAL DIMENSIONS

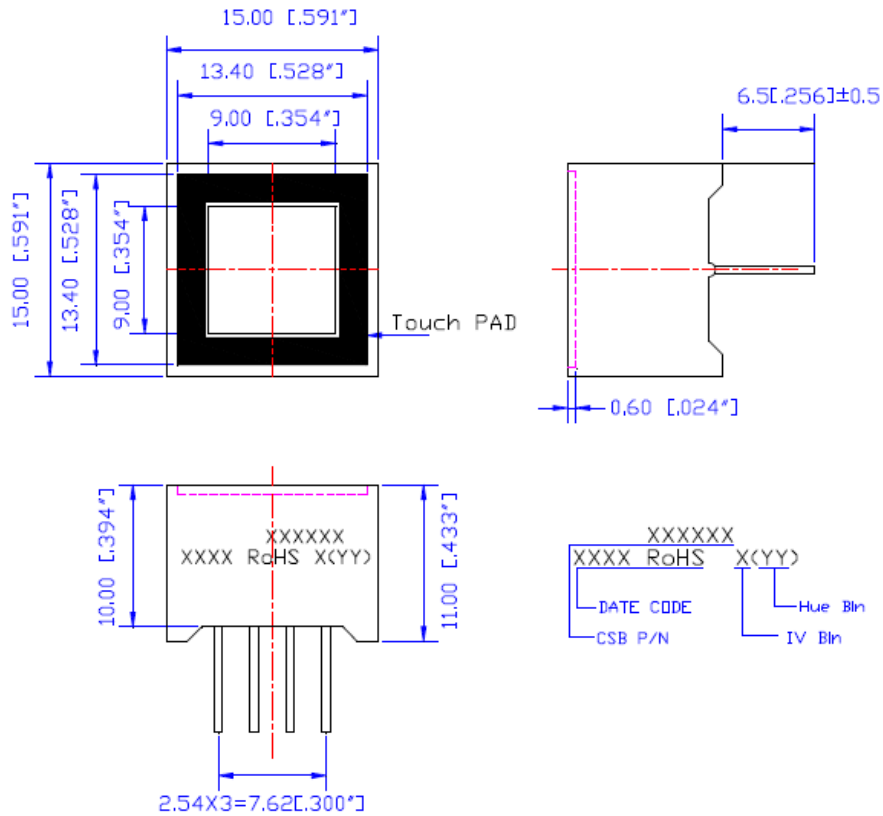

Notes:

1. All pins are 0.60[.024]±0.1[.004]
2. Dimension in millimeter [inch], tolerance is ±0.25 [.010] and angle is ±1° unless otherwise noted.

Part Number	Color	
	Material	Color
CTD-IC591B-W/W	InGaN	Blue



American Opto Plus LED Corp.

CTD-IC591B-W/W

15.0 x 15.0 x 11.0 mm Blue Touch LED Display w/
Touch Drive IC

- ◆ Low Power Consumption
- ◆ RoHS compliant
- ◆ Case mold type
- ◆ Easy Mounting on PC board / socket

ALL LIGHT ON SEGMENTS FEATURE & PIN POSITION

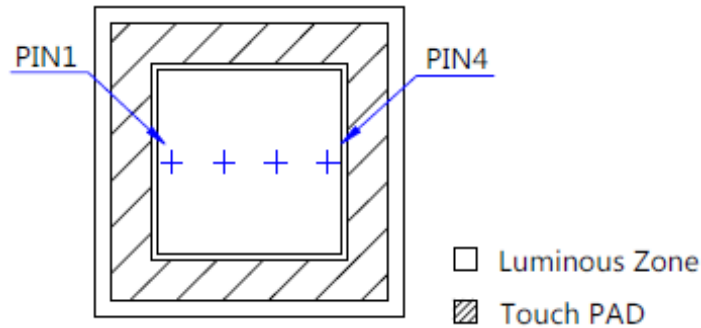

INTERNAL CIRCUIT DIAGRAMS

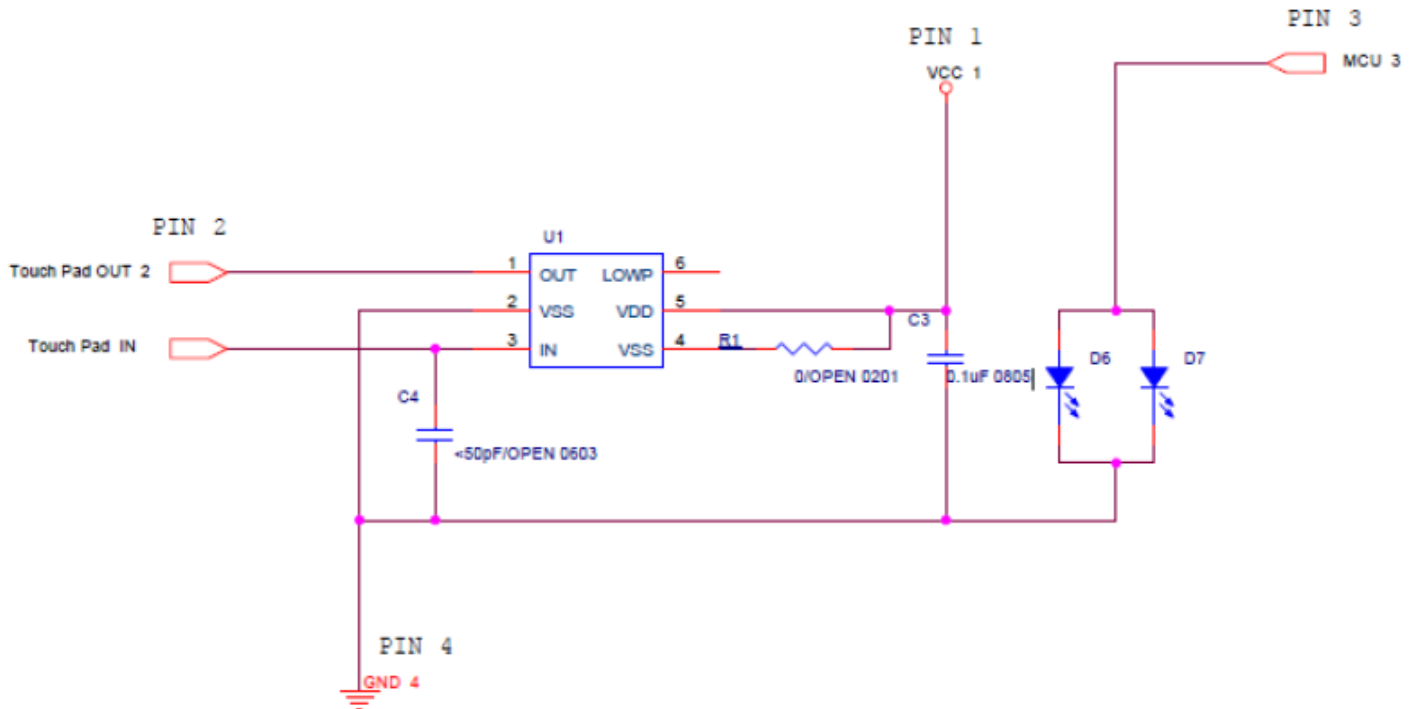



American Opto Plus LED Corp.

CTD-IC591B-W/W

**15.0 x 15.0 x 11.0 mm Blue Touch LED Display w/
Touch Drive IC**

- ◆ Low Power Consumption
- ◆ RoHS compliant
- ◆ Case mold type
- ◆ Easy Mounting on PC board / socket

ABSOLUTE MAXIMUM RATING

(Ta=25°C)

Parameter	Symbol	Rating	Unit
		Blue	
Power Dissipation Per Dice	PAD	114	mW
Derating Liner from 25°C per Dice	-	0.4	mA/°C
Continuous Forward Current Per Dice	IAF	30	mA
Peak Current Per Dice (duty cycle 1/10,1KHz)	IPF	100	mA
Reverse Voltage Per Dice	VR	5	V
Operating Temp.	Topr	-35 ~ +85	°C
Storage Temp.	Tstg	-35 ~ +85	°C

ELECTRO-OPTICAL CHARACTERISTICS

(Ta=25°C)

Parameter	Symbol	Min.	Typ.	Max.	Unit	Condition
Luminous Intensity	Iv	44	92	--	mcd	IF = 20 mA
Forward Voltage	VF	--	3.2	3.8	V	IF = 20 mA
Peak Emission Wavelength	λP	--	--	--	nm	IF = 20 mA
Dominant Wavelength	λD	--	470	--	nm	IF = 20 mA
Spectrum Radiation Bandwidth	Δλ	--	30	--	nm	IF = 20 mA
Luminous Intensity Matching Ratio	Iv-M	--	-	2 : 1	--	IF = 10 mA
Reverse Current	IR		-	50	μA	VR = 5V



American Opto Plus LED Corp.

CTD-IC591B-W/W

15.0 x 15.0 x 11.0 mm Blue Touch LED Display w/
Touch Drive IC

- ◆ Low Power Consumption
- ◆ RoHS compliant
- ◆ Case mold type
- ◆ Easy Mounting on PC board / socket

LUMINOUS GENERAL Iv BIN GRADE (I_r = 20mA)

A	B	C	D	E	F	G	H	J	K	L	M
0.155	0.249	0.399	0.640	1.025	1.641	2.627	4.204	6.727	10.764	17.224	27.559
}	}	}	}	}	}	}	}	}	}	}	}
0.248	0.398	0.639	1.024	1.640	2.626	4.203	6.726	10.763	17.223	27.558	44.095
N	P	Q	R	S	T	U	V	W	X	Y	1
44.096	70.555	112.889	180.622	288.997	462.397	739.836	1183.738	1893.982	3030.372	4848.597	7757.756
}	}	}	}	}	}	}	}	}	}	}	}
70.554	112.888	180.622	288.996	462.396	739.835	1183.737	1893.981	3030.371	4848.596	7757.755	12412.409
2	3	4	5	6	7	8	9				
4034.034	19859.858	31775.773	50841.238	81345.982	130153.573	208245.718	333193.149				
}	}	}	}	}	}	}	}	}	}	}	}
19859.857	31775.772	50841.237	81345.981	130153.572	208245.717	333193.148	533109.039				

1. Unit = mcd
2. Tolerance: ±20%

COLOR RANK LIMITS (I_r = 20mA)

2	3	4	5	6
456.0	459.0	462.0	465.0	468.0
}	}	}	}	}
458.9	461.9	464.9	467.9	470.9

1. Unit = nm
2. Tolerance: ±1



American Opto Plus LED Corp.

CTD-IC591B-W/W

**15.0 x 15.0 x 11.0 mm Blue Touch LED Display w/
Touch Drive IC**

- ◆ Low Power Consumption
- ◆ RoHS compliant
- ◆ Case mold type
- ◆ Easy Mounting on PC board / socket

ELECTRICAL/OPTICAL CHARACTERISTICS CURVES (Ta=25°C)

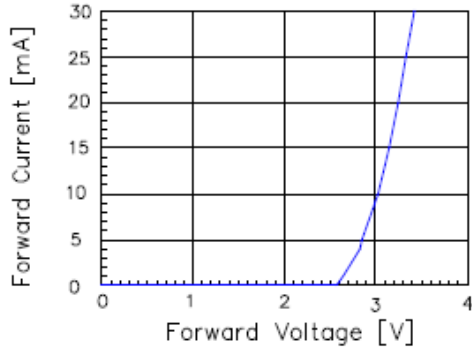

Fig 1. Forward Current vs. Forward Voltage

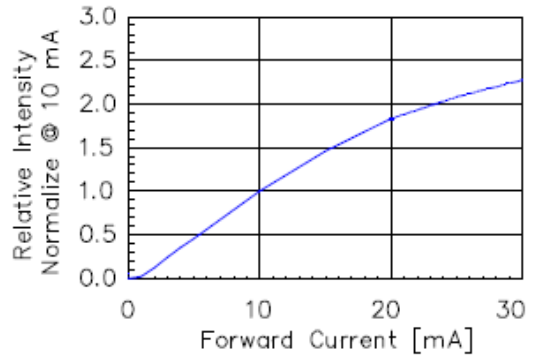

Fig 2. Relative Intensity vs. Forward Current

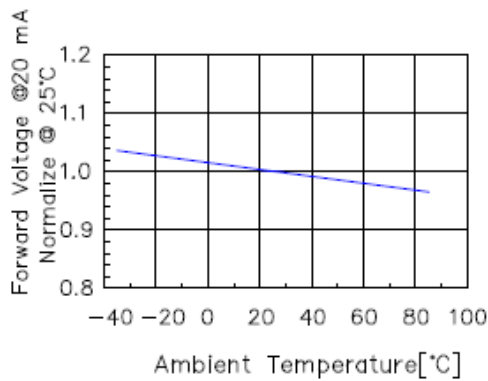

Fig 3. Forward Voltage vs. Temperature

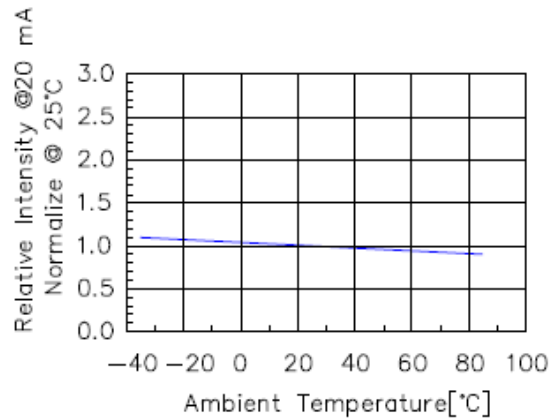

Fig 4. Relative Intensity vs. Temperature

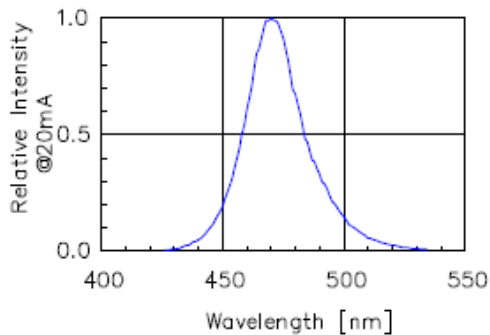

Fig 5. Relative Intensity vs. Wavelength

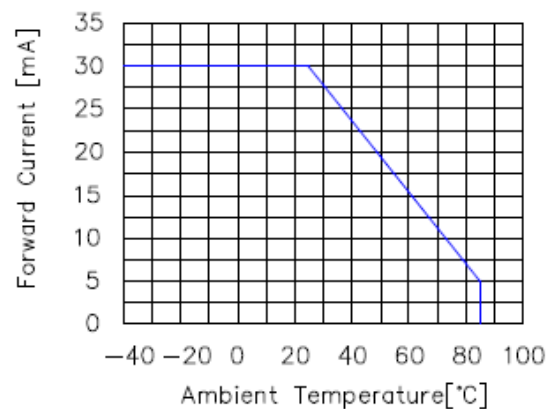

Fig 6. Forward current vs. Temperature



American Opto Plus LED Corp.

CTD-IC591B-W/W

**15.0 x 15.0 x 11.0 mm Blue Touch LED Display w/
Touch Drive IC**

- ◆ Low Power Consumption
- ◆ RoHS compliant
- ◆ Case mold type
- ◆ Easy Mounting on PC board / socket

SOLDERING CONDITIONS

1. Wave Soldering Profile

Distance: 1.6mm min (From Seating Plane)

Item	Condition		Note
Preheat	Temperature T1	80 – 120 °C	PWB Temperature (Soldering Side Surface)
	Time t1	60 – 180sec	
Solder Dip	Temperature T2	230 – 260°C	Bath Temperature
	Time t2	2 – 4 sec	Solder Tank Passage Time

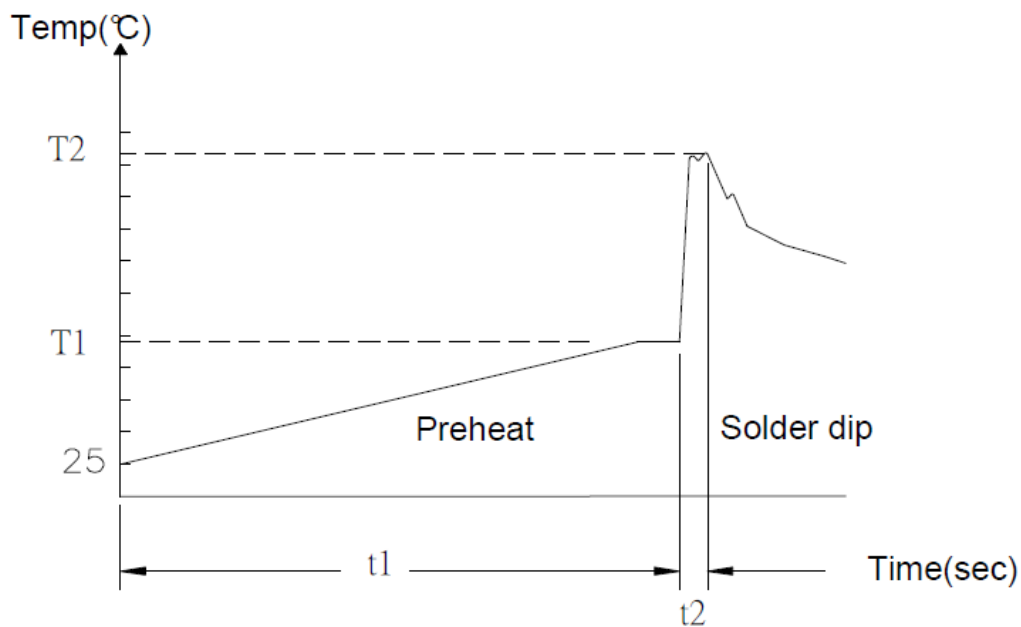

2. Hand Soldering (Iron Condition)

Soldering Iron: 30W Max

Temperature 350°C Max

Soldering Time: 3 Seconds Max (One Time)

Distance: 1.6mm min (From Seating Plane)