



USER MANUAL

FLIR TG165

Imaging IR Thermometer

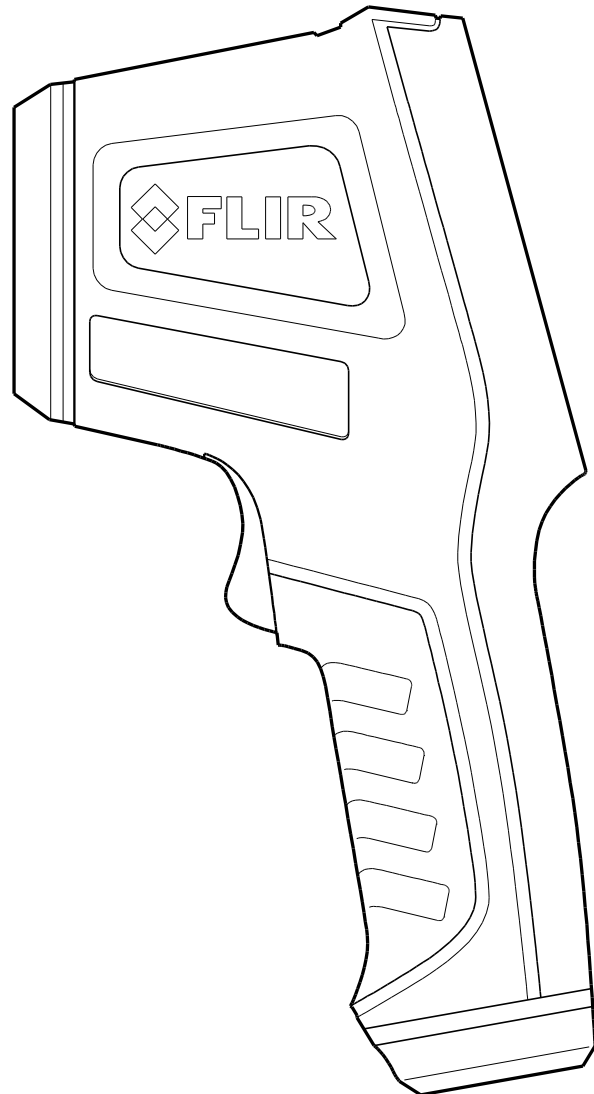
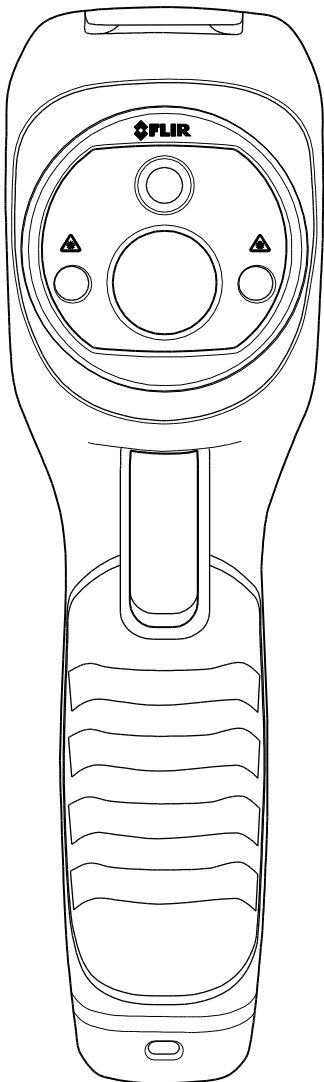

Table of Contents

1 Disclaimer	4
1.1 Copyright	4
1.2 Quality Assurance	4
1.3 Documentation	4
1.4 Disposal of Electronic Waste	4
2 Safety	5
2.1 International Safety Symbols.....	5
2.2 Cautions	5
3 Quick Start Guide	6
3.1 Basic Steps	6
3.2 Powering and Charging the TG165	6
3.3 The IR Thermal Imaging Display	6
3.4 Control Buttons and Trigger	7
3.5 Taking Measurements	7
3.6 Save, Delete, and Review IR Images	7
4 Introduction	8
4.1 Key Features	8
4.2 IR Thermometer Measurement Overview	8
4.3 IR Thermometer Distance-To-Spot Ratio (24:1)	9
4.4 IR Imager Field of View	10
5 Descriptions	11
5.1 Rear Description	11
5.2 Front Description	11
5.3 Top Description.....	11
5.4 Bottom Description	11
5.5 Display Icon and Indicator Descriptions	12
6 Powering the TG165	13
6.1 Battery Power	13
6.2 Charging the Battery.....	13
6.3 APO (Auto Power OFF)	13
6.4 Force Power OFF.....	13
7 Button and Trigger Control	14
7.1 POWER/BACK BUTTON	14
7.2 OK/MENU BUTTON	14

7.3 UP and DOWN NAVIGATION ARROW BUTTONS	14
7.4 TRIGGER BUTTON	14
8 Operation	15
8.1 Switch ON the TG165.....	15
8.2 Capture/Save Images using the SD Card	16
8.3 Review/Delete Images.....	16
9 Settings Menu.....	17
9.1 Settings Menu Overview	17
9.2 Basic Navigation and Editing.....	18
9.3 Image Review and Delete All (SD Card Erase)	19
9.4 Color Palette Selection	20
9.5 Emissivity Selection	20
9.6 Laser Pointer Toggle ON/OFF	21
9.7 Temperature Units °C/°F Toggle.....	21
9.8 Crosshairs ON/OFF Toggle	21
9.9 AUTO Power OFF (APO) Selection	22
9.10 Date and Time Setting	22
9.11 Firmware Information and Calibration Date Viewing	23
9.12 Connecting the TG165 to a PC and moving image files.....	23
10 Maintenance.....	24
10.1 Battery Service and Replacement	24
10.2 Calibration	24
10.3 Cleaning	24
11 Specifications.....	25
11.1 General Specifications	25
11.2 IR Thermometer Specifications	26
11.3 IR Thermal Imaging Specifications.....	27
11.4 Environmental Specifications	27
12 Appendices	28
12.1 Emissivity Factors for Common Materials	28
12.2 Infrared Energy and Imaging Overview	28
13 Customer Support	29
14 Warranty Information	30
14.1 FLIR Test & Measurement Imaging Product 2 year/10 year Limited Warranty	30

1 Disclaimer

1.1 Copyright

© 2014-2017, FLIR Systems, Inc. All rights reserved worldwide. No parts of the software including source code may be reproduced, transmitted, transcribed or translated into any language or computer language in any form or by any means, electronic, magnetic, optical, manual or otherwise, without the prior written permission of FLIR Systems.

The documentation must not, in whole or part, be copied, photocopied, reproduced, translated or transmitted to any electronic medium or machine readable form without prior consent, in writing, from FLIR Systems.

Names and marks appearing on the products herein are either registered trademarks or trademarks of FLIR Systems and/or its subsidiaries. All other trademarks, trade names or company names referenced herein are used for identification only and are the property of their respective owners.

1.2 Quality Assurance

The Quality Management System under which these products are developed and manufactured has been certified in accordance with the ISO 9001 standard.

FLIR Systems is committed to a policy of continuous development; therefore we reserve the right to make changes and improvements on any of the products without prior notice.

1.3 Documentation

To access the latest manuals and notifications, go to the Download tab at: <http://support.flir.com>. It only takes a few minutes to register online. In the download area you will also find the latest releases of manuals for our other products, as well as manuals for our historical and obsolete products.

1.4 Disposal of Electronic Waste



As with most electronic products, this equipment must be disposed of in an environmentally friendly way, and in accordance with existing regulations for electronic waste.



Please contact your FLIR Systems representative for more details.

2 Safety

2.1 International Safety Symbols



This symbol, adjacent to another symbol or terminal, indicates the user must refer to the manual for further information.

2.2 Cautions



- Improper use can damage the meter. Please read and understand all of the information provided in this User Guide and other included documentation before use.
- Use extreme caution when the laser pointers are on.
- Do not point the beam toward anyone's eye or allow the beam to strike the eye from a reflective surface.
- Do not use the laser near explosive gases or in other potentially explosive areas.
- Refer to the CAUTION statement label (shown below) for critical safety information.





3 Quick Start Guide

3.1 Basic Steps

The TG165 is intuitive and easy to use; here are the basic steps (covered in more detail later in this Guide):

1. Press and hold the Power button  for > 2 seconds to power ON. The FLIR logo startup screen will appear followed by the thermal image display. If the battery requires recharging, refer to Section 3.2 below.
2. Point the TG165 toward the area or object of interest and view the thermal image. Relative temperature is represented by color, hot to cold (light to dark, respectively). The IR Temperature reading (upper left on the display) represents the temperature of the spot targeted by the Crosshairs and Laser pointers.
3. Pull the trigger to activate the laser pointers.
4. Release trigger to freeze/capture the image. Press  to save image; press  to discard image.

3.2 Powering and Charging the TG165

Press and hold the power button  for > 2 seconds to switch ON the TG165. A start-up screen (FLIR Logo) will appear. The TG165 is now ready to use; to switch OFF, press and hold  for > 2 seconds. Note that the APO (Auto Power OFF) function switches the TG165 OFF automatically after a programmed period of time (refer to the Settings Menu section to program APO time).

With the power ON, the battery status icon is located at the top right of the display.

When battery power is low, connect to an AC source or a computer USB port using the supplied USB cable (USB port is located at top of the TG165, under flap).

With power OFF, the battery symbol encompasses the entire screen while charging, appearing as the symbol on the left (Fig 3-1) in a sweeping animation when connected to an AC source, and as the symbol on the right (Fig 3-1) when connected to a computer USB port.

The TG165 can also be powered up and in use while charging in which case the battery symbol is animated on the upper right in its normal location.

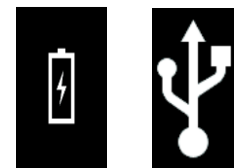

Fig 3-1 Battery charging icons

3.3 The IR Thermal Imaging Display

1. IR Thermometer surface temperature reading
2. Crosshairs: Thermometer target
3. Thermal image
4. Time Clock
5. Current Emissivity setting
6. Color scale
7. Display Icons row

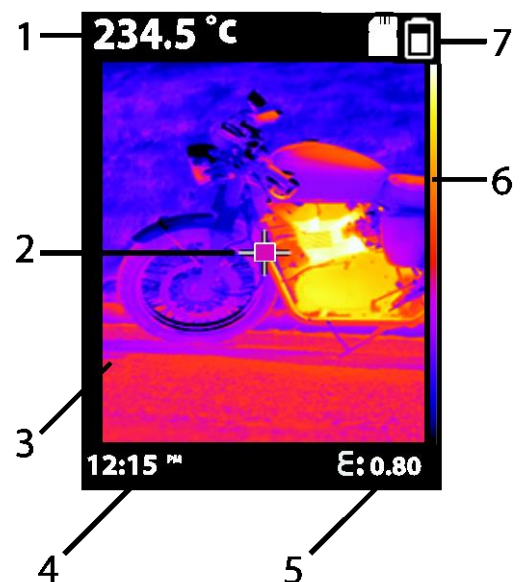





Fig 3-2 Main Display

3.4 Control Buttons and Trigger



Become familiar with the operation of the control buttons and trigger as described below:

- **POWER/BACK BUTTON**  Press and hold > 2 seconds to cycle the meter power ON or OFF; Short press to exit a menu screen. Also used to discard an image immediately after capturing an image (an 'X' will appear on the display above the button for 5 seconds when this option is available).
- **OK/MENU BUTTON**  Short press to access the Settings Menu, to confirm an edit, and to save an image when prompted (a check mark will appear on the display above the button for 5 seconds when this option is available).
- **UP and DOWN NAVIGATION ARROW BUTTONS**  Scroll the Settings Menu and select a menu item setting. Press and hold the DOWN arrow for 4 seconds to access the Image Review mode.
- **TRIGGER** Pull to activate the laser pointers and release to take a snapshot of the current image. Pull again to discard image and return to live image mode.

3.5 Taking Measurements

- Switch the TG165 ON.
- Point the lenses toward the area under test.
- Review the IR Image and the IR thermometer reading (above and to the left of the IR Image). If the thermometer measurement exceeds the published temperature range, the display shows OL.
- IR images and IR thermometer readings are captured by the IR imaging lens and the IR thermometer lens respectively.
- Pull the trigger to activate the laser pointers. The laser pointers approximately 'frame' the spot whose IR temperature is measured. The display Crosshair pinpoints the center of the spot.
- Review the display example in Fig 3.2 earlier in this section. Also review Sections 4.2 *IR Thermometer Measurement Overview*, Section 4.3 *Distance-To-Spot Ratio*, and Section 4.4 *IR Imager Overview*.

3.6 Save, Delete, and Review IR Images

- Point the TG165 toward the object or area of interest.
- Pull the trigger to activate the laser pointers and release to capture the image. A check mark appears above the  button (press to save) and an 'X' appears above the  button (press to discard) for 5 seconds.
- To review an image, either access the Settings Menu (see Section 9) or press and hold the Down arrow button for 4 seconds.
- To delete images from the SD card, access the Settings Menu and delete the stored images as described in Section 9 *Settings Menu*.

Warning: All images are deleted when the SD card is erased.

4 Introduction

Thank you for your purchase of the FLIR TG165 Imaging IR Thermometer. The TG165 is a unique IR Thermometer that blends Thermal Imaging capability with traditional IR Thermometer functionality. The TG165 purchase includes a wrist strap lanyard, micro SD memory card, universal AC adaptor/charger, and Quick Start guide. Other accessories are available at www.flir.com/test. This device is shipped fully tested and calibrated and, with proper use, will provide years of reliable service. Please visit our support website www.flir.com/test to register the device, check for the latest version of this User Guide, view product updates, and to contact Customer Support.

4.1 Key Features

- Two lenses: one for the Thermal Imager and one for the IR Thermometer
- 60 x 80 pixel thermal imaging system
- Large, easy-to-read, bright graphical TFT display
- Dual Laser Pointers
- Quick and easy emissivity selection with four preset levels and a custom emissivity mode
- Tripod Mount
- Rugged industrial design
- Lanyard on handle

4.2 IR Thermometer Measurement Overview

IR Thermometers measure an object's surface temperature. The thermometer's optics sense an object's emitted, reflected, and transmitted energy.

The TG165 translates the sensed information (approximately framed by the Lasers and further targeted by the Crosshairs) into a temperature reading that is displayed in text on the upper left corner of the display. If the thermometer measurement exceeds the published temperature range, the display shows OL.

The amount of IR energy emitted by an object is proportional to an object's temperature and its ability to emit energy. This ability is known as emissivity and is based on the material of the object and its surface finish.

Emissivity values range from 0.1 for a very reflective object to 1.00 for a flat black finish.

The TG165 has both adjustable and preset emissivity settings. There are four (4) presets and an adjustable emissivity span from 0.1 to 0.99. See the Appendix for a list of common materials and their respective Emissivity factors. Access the Settings Menu (explained in Section 9) to set the desired emissivity factor.

For an overview of IR Thermography see the Appendices, Section 12.2 *Infrared Imaging and Energy Overview*.

4.3 IR Thermometer Distance-To-Spot Ratio (24:1)

Basics

The TG165 Distance-to-Spot ratio (D:S) is 24:1. From a distance of 24" the TG165 measures the average temperature of a spot 1" in diameter. From a distance of 48" the spot diameter is 2" and from a distance of 72" the spot diameter is 3". The temperature is shown at the top left of the TG165 display.

Thermometer Lens

In Fig 4-1, the lens' field of view is represented by the green dotted lines emanating from the thermometer lens. This field of view is angled 0.04°. The spot sizes (green circles 1, 2, and 3" in diameter) are shown in Fig 4-1 at distances of 24, 48, and 72". Two views of the target spots are shown: target spots as seen from the side, and target spots as seen from the user's perspective (pointing at the target spots with TG165 in hand).

Laser Pointers

The Laser pointer lenses are shown as red (right side lens) and blue (left side lens) colored dots. These lenses are horizontal to one another on the meter but, as the meter is moved away from the target, the Laser beams rotate completely vertical so as to create a 1" spot at a distance of 24". At a distance of 48", the Lasers rotate further (2 and 8 o'clock positions) so that the spot diameter is 2". The beams remain at this position for further distances (compare the beam rotations at 48" and 72").

Display Crosshairs

The display crosshairs represent the target spot that the IR Thermometer lens is sensing.

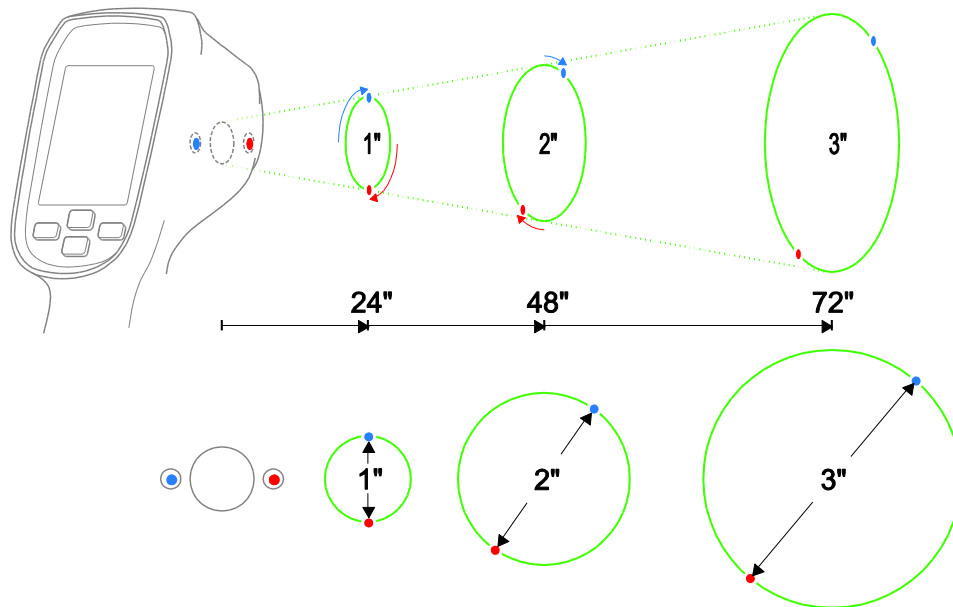

Fig 4-1 Distance to Spot ratio and the rotating Laser pointer beams

4.4 IR Imager Field of View

- Fig 4-2 shows a top view where the two dashed lines (1) represent the left and right (horizontal) boundaries of the IR Image field of view (38.6°).
- Fig 4-3 shows a side view where the dashed lines (1) represent the top and bottom (vertical) boundaries of the IR image field of view (50°).
- It is important to note that the IR Image is squared (as opposed to round, as in the case of the IR thermometer spot).
- In Fig 4-2 the two solid lines (2) represent the IR Thermometer field of view.
- Item 4 (in both figures) is the IR Image field represented by a boxed shape with bold lines.
- In Fig 4-2 the ellipses (3) represent the IR Thermometer's measured spot diameter.
- As mentioned, the TG165's crosshair circle closely approximates these spots.
- In Fig 4-2 the laser pointers (2) frame the spots (3). In Fig 4-3 the lasers' plane (2) is shown as one line instead of two (since the lasers are on the same plane when viewed from the side).
- Note that measurements should not be taken closer than 10" (25.4cm) for best results.

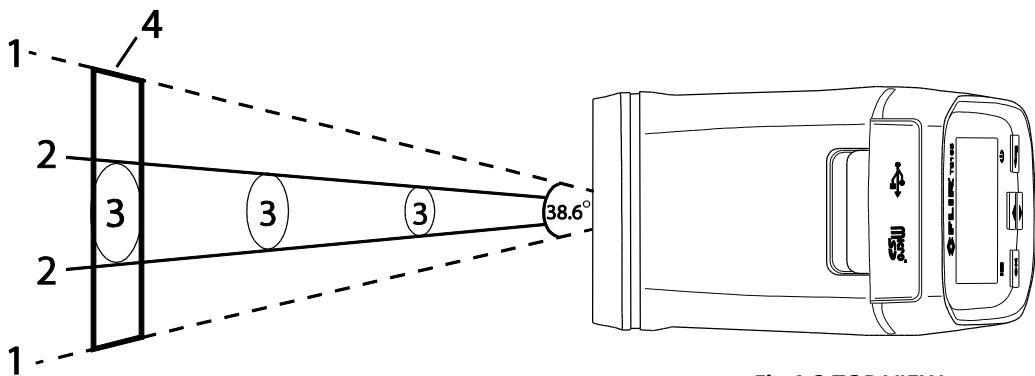

Fig 4-2 TOP VIEW
IR Imager Field of View

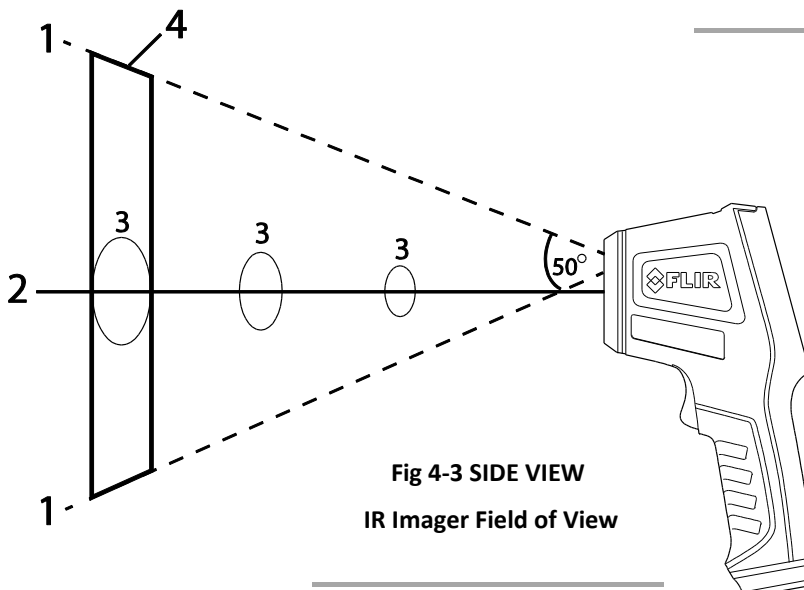
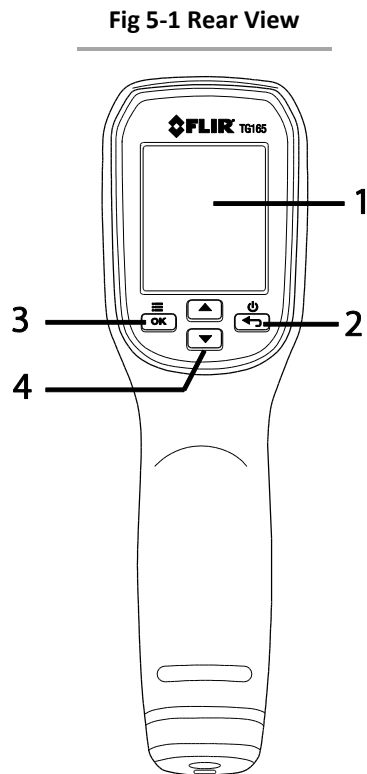

Fig 4-3 SIDE VIEW
IR Imager Field of View

5 Descriptions

5.1 Rear Description

1. TFT Color display
2. POWER-BACK button
3. MENU-OK button
4. UP-DOWN arrow buttons



5.2 Front Description

5. IR Imaging Lens
6. Dual Laser Pointers
7. IR Thermometer lens
8. Trigger
9. Lanyard access

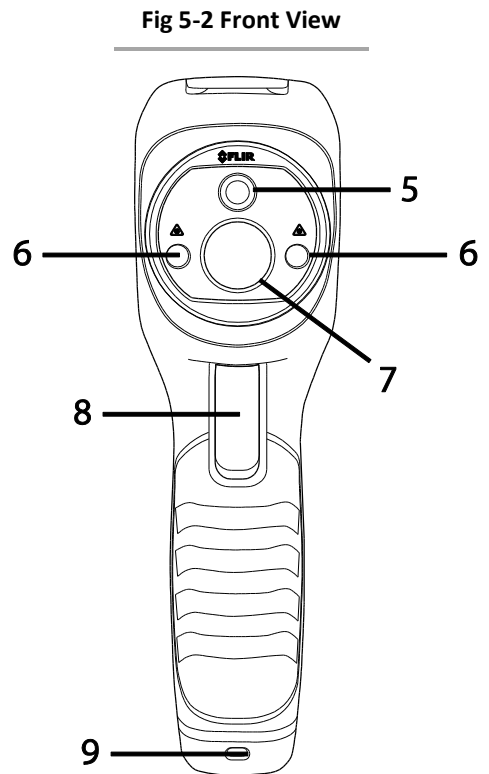

5.3 Top Description

10. Compartment for Micro USB port and Micro SD card slot

Fig 5-3 Top View

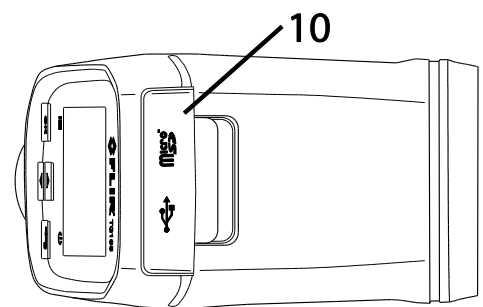





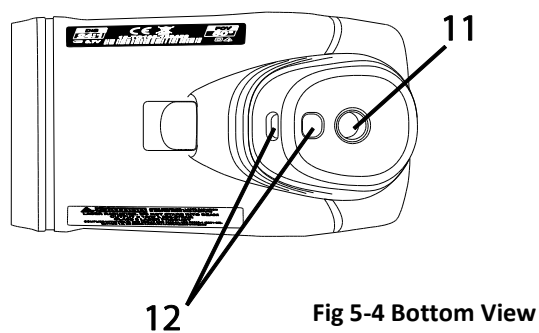

























5.4 Bottom Description

11. Tripod Mount
12. Lanyard access





5.5 Display Icon and Indicator Descriptions

Icon	Description	Icon	Description
	Settings Menu icon		Gray scale palette menu selection
	Calibration date icon		Hot iron palette menu selection
	Firmware revision icon		Matte finish (emissivity preset 0.95)
	LASER pointers ON icon		Semi-matte finish (emissivity preset 0.80)
	SD memory card detected		Semi-gloss finish (emissivity preset 0.60)
	SD card delete (erase) icon		Gloss finish (emissivity menu preset 0.30)
	Image color palette icon		Custom Emissivity menu icon
	Date/Time menu icon		Temperature units
	Hourglass icon		Previous/Next Page indicator arrows
	Targeting Crosshairs		Accept / Save indicator
	Auto Power Off (APO) icon		Abort / Delete indicator
	Operation complete		Operation failed
	Emissivity icon		Information Menu shows firmware revision level and calibration date
<p>Battery full power:  Battery empty:  AC charging icon*:  USB Port charging icon*: </p> <p>*Battery charging icons shown represent charging with meter power OFF. When charging with meter power ON, the battery status icon (top, right of display) animates in a sweeping motion.</p>			

6 Powering the TG165

6.1 Battery Power

Press and hold  for > 2 seconds to switch the TG165 ON or OFF. The TG165 is powered by a 3.7V Li-ion rechargeable battery. The Battery status icon, located on the upper right hand corner of the display, shows full white  when 100% powered. The white center of the battery icon decreases as the battery power diminishes.

The battery status icon appears empty  when the battery requires a recharge. Note that temperature readings displayed while the battery symbol is empty will be accurate. Accuracy is assured up until the meter switches OFF.

6.2 Charging the Battery

The battery is charged by connecting the supplied USB cable to the TG165 (USB port under top flap) and then to an AC source or to a USB port on a computer.

With power OFF, and the TG165 charging from an AC source, the  symbol is displayed over the entire screen.

With power OFF, and the TG165 charging from a USB port, the  symbol is displayed over the entire screen.



The TG165 can also be charged with Power ON (if the battery has enough charge to power the unit). While charging with power ON (from either an AC source or USB computer port), the battery status indicator (top right of display) appears animated in a sweeping motion.

6.3 APO (Auto Power OFF)

The TG165 automatically shuts off after a selectable period of inactivity. Please refer to Section 9, *Settings Menu*, for instructions on setting the APO time. The APO options are OFF (where unit does not power off automatically), 1 minute, 2 minutes, 5 minutes, or 10 minutes.

6.4 Force Power OFF

In the event that the TG165 display freezes or 'locks up', the TG165 can be forced to reset and power down.

Press and hold  and, while holding it down, press and hold  for 10 seconds. The meter will reset and power down.

7 Button and Trigger Control

The TG165 has four (4) control buttons located directly below the display, in addition to the trigger. Hint: Use the thumb for button control and the index finger for the trigger control.

7.1 POWER/BACK BUTTON

Press and hold: Cycle meter power ON-OFF

Short press: Exit a mode or discard an image (when an 'x' appears on the display above the button)

7.2 OK/MENU BUTTON

Short press: Accesses the Settings Menu, confirms/opens a menu parameter, toggles a menu option, and stores an image when a check mark is displayed above it.

7.3 UP and DOWN NAVIGATION ARROW BUTTONS

Short press: Scroll the selections in the Settings Menu and scroll stored images in the Image Review mode:

From the normal mode of operation, a 4 second press of the Down arrow accesses Image Review mode;

alternatively, access Image Review/Delete mode as described in Section 9, Settings Menu.

7.4 TRIGGER BUTTON

Activates laser pointers and, when released, takes a snapshot.

8 Operation

8.1 Switch ON the TG165

Press and hold **⏻** for > 2 seconds to switch the TG165 ON. If the unit is sufficiently charged, the meter will display the FLIR logo start-up screen as shown below in Fig 8-1. The initial displayed image may show a low resolution image with multiple colored lines until the shutter resets the image. After the startup period, the TG165 will show a real time IR thermal image along with an IR Temperature reading (in text above the thermal image). If the meter does not switch ON, please refer to Section 6 *Powering the TG165*, for information regarding battery charging.



Fig 8-1 Start-up Screen

8.2 Capture/Save Images using the SD Card

The TG165 can store thousands of images on a Micro SD memory card. When connected to a PC via the supplied USB cable, the Micro SD card functions as any external storage drive. To store images, a compatible Micro SD card must be inserted in the Micro SD card slot at the top of the meter (under the protective flap).

When a compatible Micro SD card is properly inserted in the TG165 the memory card icon  will appear at the top right of the TG165 display. To capture an image and save it to memory:









1. Point the TG165 at an object or an area of interest.
2. Pull the trigger to activate the laser pointers.
3. Release the trigger to capture the image; the image will freeze for 5 seconds.
4. Press  to save the image or  to discard the image (see Fig 8-2) within 5 seconds.
5. If the image is stored successfully on the Micro SD card, a large check mark  will appear on the center of the display. If the image fails to save, this icon  will appear on the display. A failure may indicate a full, faulty, or incorrectly inserted Micro SD card.



Fig 8-2 Image Save or Discard screen

6. To erase/format an SD card please refer to Section 9 *Settings Menu*.

Hint: After an image is captured, a check mark  appears above the  button (save image) and an  icon appears above the  button (discard image) for 5 seconds. Refer to Fig 8-2. If not buttons are pressed within 5 seconds, the image is automatically discarded.

8.3 Review/Delete Images

Use the Review Mode to view or delete stored images.

















1. To access the Image Review mode (from the normal operating mode), press and hold the Down arrow button for 4 seconds and then use the arrow buttons to scroll through the images. Alternatively, access the Settings Menu (Section 9) to review and delete images.
2. Press the back button  to exit the image review mode
3. To delete all images, please access the Settings Menu as described in Section 9 and reformat the SD card.
4. Connect the TG165 to a PC using the supplied USB cable and use the SD card as an external drive for storing and deleting images.

9 Settings Menu



9.1 Settings Menu Overview

The Settings Menu allows the user to configure the TG165 in a variety of ways. Refer to the Table (Fig 9-1) below for a list of options. Menu settings changed by the user remain saved each time the TG165 is powered OFF and ON.

Fig 9-1 Settings Menu Items

Icon	Description
	Image review and delete mode (see Section 9.3)
	 Color (Hot Iron) palette selection  Black & White palette selection Toggle using the  button
	Emissivity setting (see Section 9.5)
	Laser Pointers: Press  to toggle lasers ON/OFF
	Temperature Units: Press  to toggle °C/°F
	Crosshairs: Press  to toggle crosshairs ON/OFF
	Auto Power OFF (APO) setting (see Section 9.9)
	Date and Time setting (see Section 9.10)
	 Firmware version display  Calibration date display See Section 9.11

9.2 Basic Navigation and Editing

Press  to enter the Settings Menu (see Fig 9-2). Use the arrow buttons to scroll through the displayed menu items and pages (not all of the menu items can be seen on one page). The current option will be highlighted. Press  to open a menu item or to toggle an option (items that can be toggled using the  button are: color palette, laser pointer ON/OFF, Temperature Units C/F, and Crosshairs ON/OFF).

Each menu item is detailed in the following sections.

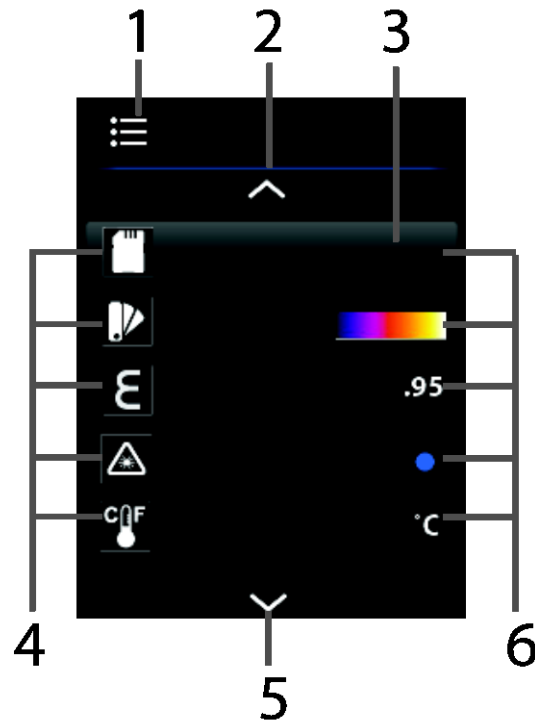

Fig 9-2 Navigating the Main Menu

1. Settings Menu icon
2. Scroll up icon (use the Up arrow button to view more menu items)
3. Highlighted background indicates the selected item
4. Menu item icons (scroll these using the arrow buttons)
5. Scroll down indicator (use the Down arrow button to view more menu items)
6. Current menu item settings

9.3 Image Review and Delete All (SD Card Erase)

To review or delete all images stored on the SD memory card:









1. Press  to access the Settings Menu
2. Scroll to the SD card  icon.
3. Press  to open the menu item and two icons will be shown: The Image Review icon (top) and the SD Card Erase icon (bottom) as shown in Fig 9-3.
4. With the Image Review icon  highlighted press  and then use the arrow keys to scroll through the stored images (the image filenames are shown directly below the images). See Fig 9-4. When finished press the Back button  to return to the Normal operating mode.
5. Press the Menu button with the SD Card Erase icon  highlighted to erase/reformat an installed SD card. ALL DATA WILL BE ERASED. The hourglass icon will be displayed for approximately 20 seconds while the card is being reformatted as shown in Fig 9-5. After reformatting, the TG165 will return to the Settings Menu.
6. Use the arrow buttons to select another menu item or press the Back button  to return to the normal operating mode.



Fig 9-3 Selecting the Image Review Icon

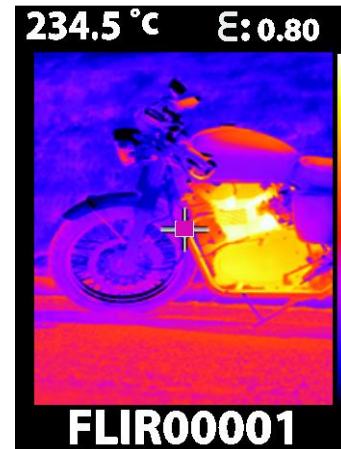

Fig 9-4 Scrolling Images with Arrow Buttons

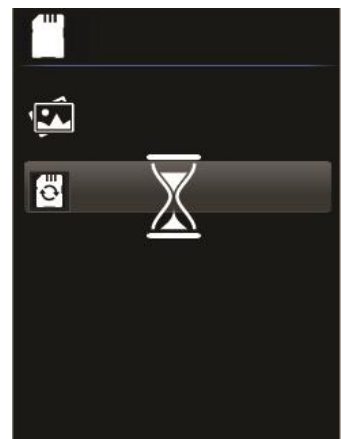







Fig 9-5 Deleting SD Card Images





9.4 Color Palette Selection

The TG165 supports two color palettes, Grayscale and Hot-Iron. The default palette is Hot-Iron.

1. Press  to access the Settings Menu and use the arrows to scroll to the COLOR PALETTE  icon.
2. Use the  button to toggle Grayscale  and Hot-Iron  selections.
3. When selection is complete, use the arrow buttons to scroll to another menu item.

9.5 Emissivity Selection

The emissivity is adjustable in 0.01 steps from 0.01 to 0.99; the default value is 0.95. Refer to the Appendix for a list of common materials and their respective Emissivity factors.

1. Press  to access the Settings Menu and use the arrow buttons to scroll to the EMISSIVITY  icon.
2. Press  to open the menu item.
3. PRESET EMISSIVITY SELECTION: Use the arrow buttons to scroll to one of the preset emissivity factors (95, 80, 60, 30) as shown in Fig 9-6 and then press  to confirm the selection. The meter will return to the Settings Menu.
4. CUSTOM EMISSIVITY: Use the arrow buttons to scroll to the

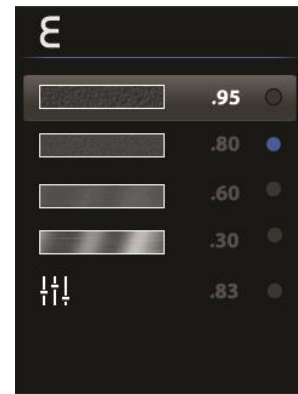

Fig 9-6 Selecting an Emissivity Preset









- Custom Emissivity icon  as shown in Fig 9-7 and press  to initiate editing. Now use the arrow buttons to select the desired emissivity value (from 0.01 to 0.99). Press  to confirm the custom setting and the meter will return to the Settings Menu.
5. Use the arrow buttons to select another menu item or press  to return to the normal operating mode.







Fig 9-7 Selecting a Custom Emissivity

9.6 Laser Pointer Toggle ON/OFF





1. Press  to access the Settings Menu and use the arrow buttons to scroll to the Laser Pointer  icon.
2. Use the  button to toggle the laser pointer ON/OFF.
3. The Laser pointers are used to frame the the IR Thermometer measurement 'spot'. See Section 4.3.
4. When selection is complete, use the arrow buttons to scroll to another menu item or press  to return to the normal operating mode.

9.7 Temperature Units °C/°F Toggle

The TG165 displays temperatures in °C and °F units.





1. Press  to access the Settings Menu and use the arrow buttons to scroll to the TEMPERATURE UNITS  icon.
2. Use the  button to toggle the Temperature units (C/F).
3. When selection is complete, use the arrow buttons to scroll to another menu item or press  to return to the normal operating mode.

9.8 Crosshairs ON/OFF Toggle

1. Press  to access the Settings Menu and use the arrow buttons to scroll to the Crosshairs  icon. The crosshairs target the center of the IR Thermometer measurement 'spot', refer to sections 4.3 and 4.4 for more detail. The IR thermometer temperature is displayed above and to the left of the IR image.
2. Use the  button to toggle the Crosshairs display ON/OFF.
3. When selection is complete, use the arrow buttons to scroll to another menu item or press  to return to the normal operating mode.

9.9 AUTO Power OFF (APO) Selection

Select the period of time (from the last button-press) that the meter will wait before automatically switching OFF.

1. Press  to access the Settings Menu and use the arrow buttons to scroll to the APO  icon.
2. Press  to open the menu item.
3. Use the arrow keys to scroll to the desired APO time (OFF, 1 minute, 2 minutes, 5 minutes, and 10 minutes). See Fig 9-8.
4. Press  to save the setting and return to the Settings Menu.

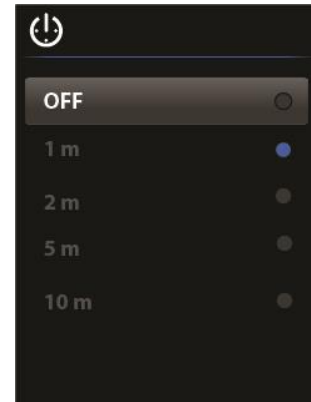









Fig 9-8 Selecting APO time

9.10 Date and Time Setting

In the System date and time menu, the user can set the time and date as follows:

1. Press  to access the Settings Menu and use the arrow buttons to scroll to the DATE/TIME  icon.
2. Press  to open the DATE/TIME sub-menu. The TIME and DATE fields will appear with the 24-Clock ON-OFF selector. The selected row will be highlighted as shown in Fig 9-9 and Fig 9-10. Use the arrow buttons to navigate from row to row.
3. Use the  button to move from field to field within the highlighted row; use arrow buttons to adjust the field's settings.
4. When the current row is finished, press  to unselect all fields and then use the arrow keys to move to the other row. Edit this row in the same manner.
5. On the 24-Clock ON-OFF row, use the OK button to toggle the 24 clock ON and OFF. When 24-hour Clock is ON, the AM-PM field with disappear.
6. When editing is complete, press  to un-highlight all of the fields and then press  again to save and return to the Settings Menu.

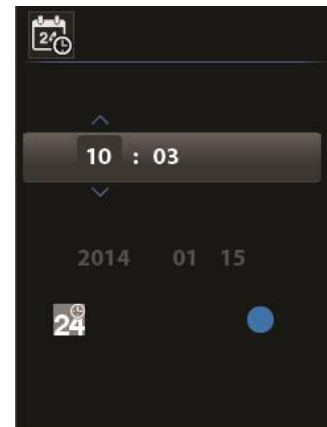







Fig 9-9 Setting the Time



Fig 9-10 Setting the Date

9.11 Firmware Information and Calibration Date Viewing

The firmware version and calibration date can be viewed (the TG165 supports in-the-field firmware updates; contact the local distributor or the FLIR technical support professionals for details).

1. Press  to access the Settings Menu and use the arrow buttons to scroll to the FIRMWARE  icon.
2. Press  to open the menu item.
3. View the firmware revision and release date.
4. Press  to return to the main menu.
5. Use the arrow buttons to select another menu item or press  to return to the normal operating mode.

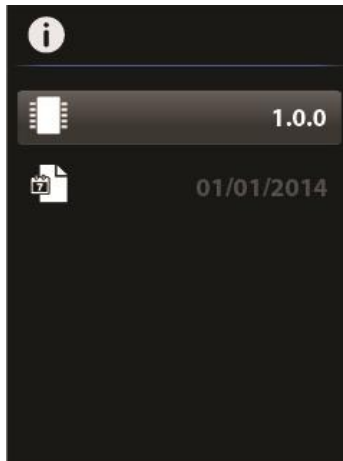

Fig 9-11 Viewing the Firmware Revision and Calibration Date

9.12 Connecting the TG165 to a PC and moving image files

The saved images on the TG165 can be moved from the memory to a PC for archiving or importing into a report.

You can remove the SD memory card from the TG165 and place it into a SD card reader or you can connect the TG165 to the PC via the supplied USB cable.

When connecting the TG165 to a PC using a USB cable

Power the TG165 OFF.

Plug in the USB cable to the TG165 and then into the PC.

The TG165 display will show the USB symbol. .

Copy off the images you want to save.

10 Maintenance

10.1 Battery Service and Replacement

If the battery will not hold a charge and requires replacement, please contact FLIR Systems for details on returning the unit for service. For instructions on charging the battery please refer to Section 6.2 *Charging the Battery*.

10.2 Calibration

The TG165 is calibrated at the factory prior to shipment. If calibration is required please contact a local FLIR service center. The TG165 is not serviceable in the field and should only be calibrated by trained, qualified FLIR personnel.

10.3 Cleaning

Wipe the housing with a damp cloth as needed. Use a high quality lens wipe to remove dirt or smudges from the meter lenses and display window. Please do not use abrasives or solvents to clean the meter housing, lenses, or display window.

11 Specifications

11.1 General Specifications

Display	2.0" Color TFT
Display resolution	176 (W) x 220 (H) pixels
Laser Pointers	Dual diverging system (red); Pull Trigger to activate laser pointers Lasers frame the IR thermometer's measurement spot
Drop-proof	Designed for up to 2 meters
Battery power	Rechargeable 3.7V (2600mA) lithium ion battery (not user-serviceable) Charge via Micro USB port (top of meter, under flap)
Battery Charger Ratings	100-240V, 50/60Hz, CAT II
Automatic Power OFF	User-adjustable (OFF, 1 minute, 2 minutes, 5 minutes, or 10 minutes)
Battery life	> 5 hours; typical
Tripod mounting	¼"-20 threaded mount located on bottom of meter handle
Field upgradable	Firmware can be updated in the field (contact FLIR Systems)
Data Recording	Micro SD card (included); up to 32GB compatible
User Manual	Stored on supplied Micro SD card
Certifications	CE/FDA
Warranty	2 years (Product); 10 years (Thermal Imaging Detector)
Accessories	Includes Lanyard, USB Cable, Universal AC adaptor, User Guide
Dimensions (H x W x D)/Weight	7.3 x 2.2 x 3.7" (186 x 55 x 94mm); 11 oz. (312g)

This unit is acceptable for use in both domestic and industrial applications per UL.

11.2 IR Thermometer Specifications

IR Temperature Measurement range	-13°F to 716°F (-25°C to 380°C)
Over- and under- range indication	OL
IR Temperature Resolution	0.1°F (0.1°C)
IR Temperature Accuracy	-13° ~ +14°F (-25° ~ -10°C): (±5.4°F (±3.0°C) +14° ~ +32°F (-10° ~ 0°C): ±3.6°F (±2.0°C) +32° ~ +716°F (0° ~ +380°C): ±2.7°F (±1.5°C) or ±1.5% (whichever is greater)
Distance to Spot (D:S) ratio	24:1
Field of view angle	0.04°
IR Temperature Response Time	150ms
Temperature Scanning	Continuous
Emissivity	4 presets plus a custom setting (0.01 to 0.99)
Laser Pointers	Dual diverging (red), frame the IR thermometer measurement spot
Targeting	Displayed Crosshairs pinpoint center of measurement spot

11.3 IR Thermal Imaging Specifications

Detector type	FLIR Lepton™; Micro-bolometer Focal Plane Array (FPA)
IR Imaging resolution	60 x 80 pixels
IR Imaging field of view	50° x 38.6° (vertical x horizontal)
IR Imaging spectral response	8 to 14µm
IR Image Capture Frequency	9Hz
Upper scene range	127°C, 260°F, 400°K
IR Image Presentation	Programmable: Hot-Iron (color) and Gray scale
Shutter	Integrated, automatic shutter
Save image format	Bitmap (.bmp) with temperature and emissivity

11.4 Environmental Specifications

For Indoor Use Only	
Pollution Degree 2	
Operating Temperature	14 to 113°F (-10 to 45°C)
Storage Temperature	-22 to 131°F (-30 to 55°C)
Relative Humidity	0% to 90% [32°F to 98.6°F (0 °C - 37 °C)] 0% to 65% [98.6°F to 113°F (37 °C - 45 °C)] 0% to 45% [113°F to 131°F (45 °C - 55 °C)]
Altitude	Up to 2000m

12 Appendices

12.1 Emissivity Factors for Common Materials

Material	Emissivity	Material	Emissivity
Asphalt	0.90 to 0.98	Cloth (black)	0.98
Concrete	0.94	Skin (human)	0.98
Cement	0.96	Leather	0.75 to 0.80
Sand	0.90	Charcoal (powder)	0.96
Soil	0.92 to 0.96	Lacquer	0.80 to 0.95
Water	0.92 to 0.96	Lacquer (matt)	0.97
Ice	0.96 to 0.98	Rubber (black)	0.94
Snow	0.83	Plastic	0.85 to 0.95
Glass	0.90 to 0.95	Timber	0.90
Ceramic	0.90 to 0.94	Paper	0.70 to 0.94
Marble	0.94	Chromium Oxides	0.81
Plaster	0.80 to 0.90	Copper Oxides	0.78
Mortar	0.89 to 0.91	Iron Oxides	0.78 to 0.82
Brick	0.93 to 0.96	Textiles	0.90

12.2 Infrared Energy and Imaging Overview

A thermal imager generates an image based on temperature differences. In a thermal image the hottest item in the scene appears as white and the coldest item as black, and all other items are represented as a gray scale value between white and black.

It may take some time to get used to the thermal imagery. Having a basic understanding of the differences between thermal and daylight cameras can help with getting the best performance from the TG165.

One difference between thermal and daylight cameras has to do with where the energy comes from to create an image. When viewing an image with an ordinary camera, there has to be some source of visible light (something hot, such as the sun or lights) that reflects off of the objects in the scene to the camera. The same is true with human eyesight; the vast majority of what people see is based on reflected light energy. On the other hand, the thermal imager detects energy that is directly radiated from objects in the scene.

This is why hot objects such as parts on an engines and exhaust pipes appear white, while the sky, puddles of water and other cold objects appear dark (or cool). Scenes with familiar objects will be easy to interpret with some experience.

Infrared energy is part of a complete range of radiation called the electromagnetic spectrum. The electromagnetic spectrum includes gamma rays, X-rays, ultraviolet, visible, infrared, microwaves (RADAR), and radio waves. The only difference is their wavelength or frequency. All of these forms of radiation travel at the speed of light. Infrared radiation lies between the visible and RADAR portions of the electromagnetic spectrum.

The primary source of infrared radiation is heat or thermal radiation. Any object which has a temperature radiates in the infrared portion of the electromagnetic spectrum. Even objects that are very cold, such as an ice cube, emit infrared. When an object is not quite hot enough to radiate visible light, it will emit most of its energy in the infrared. For example, hot charcoal may not give off light, but it does emit infrared radiation, which we feel as heat. The warmer the object, the more infrared radiation it emits.

Infrared imaging devices produce an image of invisible infrared or “heat” radiation that is unseen by the human eye. There are no colors or “shades” of gray in infrared, only varying intensities of radiated energy. The infrared imager converts this energy into an image that we can interpret.

The Infrared Training center offers training (including online training) and certification in all aspects of thermography: <http://www.infraredtraining.com/>.

13 Customer Support

Main Website	http://www.flir.com/test
Technical Support Website	http://support.flir.com
Technical support Email	TMSupport@flir.com
Service/Repair Support Email	Repair@flir.com
Support Telephone number	+1 855-499-3662 (toll-free)

14 Warranty Information

14.1 FLIR Test & Measurement Imaging Product 2 year/10 year Limited Warranty

Congratulations! You (the “Purchaser”) are now the owner of a world-class FLIR Imaging Test and Measurement product. A qualifying FLIR Imaging Test and Measurement product (the “Product”) purchased either directly from FLIR Commercial Systems Inc. and affiliates (FLIR) or from an authorized FLIR distributor that Purchaser registers on-line with FLIR is eligible for coverage under FLIR’s industry-leading 2-10 Limited Warranty, subject to the terms and conditions in this document. This warranty only applies to purchases of Qualifying Products (see below) purchased after July 2014 and only to the original Purchaser of the Product.

PLEASE READ THIS DOCUMENT CAREFULLY; IT CONTAINS IMPORTANT INFORMATION ABOUT THE PRODUCTS THAT QUALIFY FOR COVERAGE UNDER THE 2-10 LIMITED WARRANTY, PURCHASER’S OBLIGATIONS, HOW TO ACTIVATE THE WARRANTY, WARRANTY COVERAGE, AND OTHER IMPORTANT TERMS, CONDITIONS, EXCLUSIONS AND DISCLAIMERS.

1. PRODUCT REGISTRATION. To qualify for FLIR’s 2-10 Limited Warranty, the Purchaser must fully register the Product directly with FLIR on-line at www.flir.com WITHIN Sixty (60) DAYS of the date the Product was purchased by the first retail customer (the “Purchase Date”). PRODUCTS THAT ARE NOT REGISTERED ON-LINE WITHIN Sixty (60) DAYS OF THE PURCHASE DATE OR PRODUCTS WHICH DO NOT QUALIFY FOR THE 2-10 WARRANTY WILL HAVE A LIMITED ONE YEAR WARRANTY FROM THE DATE OF PURCHASE.

2. QUALIFYING PRODUCTS. Upon registration, a list of thermal Imaging Test and Measurement Products that qualify for coverage under FLIR’s 2-10 Warranty can be found at www.flir.com/testwarranty

3. WARRANTY PERIODS. The 2-10 Limited Warranty has two separate periods of warranty coverage (the “Warranty Period”), depending on the Imaging Test and Measurement Product part: Product components (excluding thermal imaging sensor) are warranted for a period of two (2) years from the Purchase Date; Thermal imaging sensor is warranted for a period of ten (10) years from the Purchase Date.

Any Product that is repaired or replaced under warranty is covered under this 2-10 Limited Warranty for one hundred eighty days (180) days from the date of return shipment by FLIR or for the remaining duration of the applicable Warranty Period, whichever is longer.

4. LIMITED WARRANTY. In accordance with the terms and conditions of this 2-10 Limited Warranty, and except as excluded or disclaimed in this document, FLIR warrants, from the Purchase Date, that all fully registered Products will conform to FLIR’s published Product specifications and be free from defects in materials and workmanship during the applicable Warranty Period. PURCHASER’S SOLE AND EXCLUSIVE REMEDY UNDER THIS WARRANTY, AT FLIR’S SOLE DISCRETION, IS THE REPAIR OR REPLACEMENT OF DEFECTIVE PRODUCTS IN A MANNER, AND BY A SERVICE CENTER, AUTHORIZED BY FLIR. IF THIS REMEDY IS ADJUDICATED TO BE INSUFFICIENT, FLIR SHALL REFUND PURCHASER’S PAID PURCHASE PRICE AND HAVE NO OTHER OBLIGATION OR LIABILITY TO BUYER WHATSOEVER.

5. WARRANTY EXCLUSIONS AND DISCLAIMERS. FLIR MAKES NO OTHER WARRANTY OF ANY KIND WITH RESPECT TO THE PRODUCTS. ALL OTHER WARRANTIES, EXPRESS OR IMPLIED, INCLUDING BUT NOT LIMITED TO IMPLIED WARRANTIES OF MERCHANTABILITY, FITNESS FOR A PARTICULAR PURPOSE (EVEN IF PURCHASER HAS NOTIFIED FLIR OF ITS INTENDED USE FOR THE PRODUCTS), AND NON-INFRINGEMENT ARE EXPRESSLY EXCLUDED FROM THIS AGREEMENT.

THIS WARRANTY EXPRESSLY EXCLUDES ROUTINE PRODUCT MAINTENANCE, AND SOFTWARE UPDATES. FLIR FURTHER EXPRESSLY DISCLAIMS ANY WARRANTY COVERAGE WHERE THE ALLEGED NONCONFORMITY IS DUE TO NORMAL WEAR AND TEAR OTHER THAN SENSORS, ALTERATION, MODIFICATION, REPAIR, ATTEMPTED REPAIR, IMPROPER USE, IMPROPER MAINTENANCE, NEGLIGENCE, ABUSE, IMPROPER STORAGE, FAILURE TO FOLLOW ANY PRODUCT INSTRUCTIONS, DAMAGE (WHETHER CAUSED BY ACCIDENT OR OTHERWISE), OR ANY OTHER IMPROPER CARE OR HANDING OF THE PRODUCTS CAUSED BY ANYONE OTHER THAN FLIR OR FLIR'S EXPRESSLY AUTHORIZED DESIGNEE.

THIS DOCUMENT CONTAINS THE ENTIRE WARRANTY AGREEMENT BETWEEN PURCHASER AND FLIR AND SUPERSEDES ALL PRIOR WARRANTY NEGOTIATIONS, AGREEMENTS, PROMISES AND UNDERSTANDINGS BETWEEN PURCHASER AND FLIR. THIS WARRANTY MAY NOT BE ALTERED WITHOUT THE EXPRESS WRITTEN CONSENT OF FLIR.

6. WARRANTY RETURN, REPAIR AND REPLACEMENT. To be eligible for warranty repair or replacement, Purchaser must notify FLIR within thirty (30) days of discovering of any apparent defect in materials or workmanship. Before Purchaser may return a Product for warranty service or repair, Purchaser must first obtain a returned material authorization (RMA) number from FLIR. To obtain the RMA number Owner must provide an original proof of purchase. For additional information, to notify FLIR of an apparent defect in materials or workmanship, or to request an RMA number, visit www.flir.com. Purchaser is solely responsible for complying with all RMA instructions provided by FLIR including but not limited to adequately packaging the Product for shipment to FLIR and for all packaging and shipping costs. FLIR will pay for returning to Purchaser any Product that FLIR repairs or replaces under warranty.

FLIR reserves the right to determine, in its sole discretion, whether a returned Product is covered under warranty. If FLIR determines that any returned Product is not covered under warranty or is otherwise excluded from warranty coverage, FLIR

may charge Purchaser a reasonable handling fee and return the Product to Purchaser, at Purchaser's expense, or offer Purchaser the option of handling the Product as a non-warranty return. FLIR shall not be responsible for any data, images or other information that may be stored on the returned Product which was not included in the Product at the time of purchase. It is Purchaser's responsibility to save any and all data prior to returning the Product for warranty service.

7. NON-WARRANTY RETURN. Purchase may request that FLIR evaluate and service or repair a Product not covered under warranty, which FLIR may agree to do in its sole discretion. Before Purchaser returns a Product for non-warranty evaluation and repair, Purchaser must contact FLIR by visiting www.flir.com to request an evaluation and obtain an RMA. Purchaser is solely responsible for complying with all RMA instructions provided by FLIR including but not limited to adequately packaging the Product for shipment to FLIR and for all packaging and shipping costs. Upon receipt of an authorized non-warranty return, FLIR will evaluate the Product and contact Purchaser regarding the feasibility of and the costs and fees associated with Purchaser's request. Purchaser shall be responsible for the reasonable cost of FLIR's evaluation, for the cost of any repairs or services authorized by Purchaser, and for the cost of repackaging and returning the Product to Purchaser.

Any non-warranty repair of a Product is warranted for one hundred eighty days (180) days from the date of return shipment by FLIR to be free from defects in materials and workmanship only, subject to all of the limitations, exclusions and disclaimers in this document.



Corporate Headquarters

FLIR Systems, Inc.

2770 SW Parkway Avenue

Wilsonville, OR 97070

USA

Telephone: +1 503-498-3547

Customer Support

Technical Support Website <http://support.flir.com>

Technical Support Email TMSupport@flir.com

Service and Repair Email Repair@flir.com

Customer Support Telephone +1 855-499-3662 (toll free)

Publication Identification No.: TG165-en-US

Release version: AB

Release Date: 2017 January

Language: en-US