

## STRADELLA-CY

Beam for canopy lighting with batwing light distribution. Suitable for symmetrical tunnel lighting.

### SPECIFICATION:

Dimensions	13.9 x 13.9 mm
Height	4.7 mm
Fastening	pin
ROHS compliant	yes ⓘ

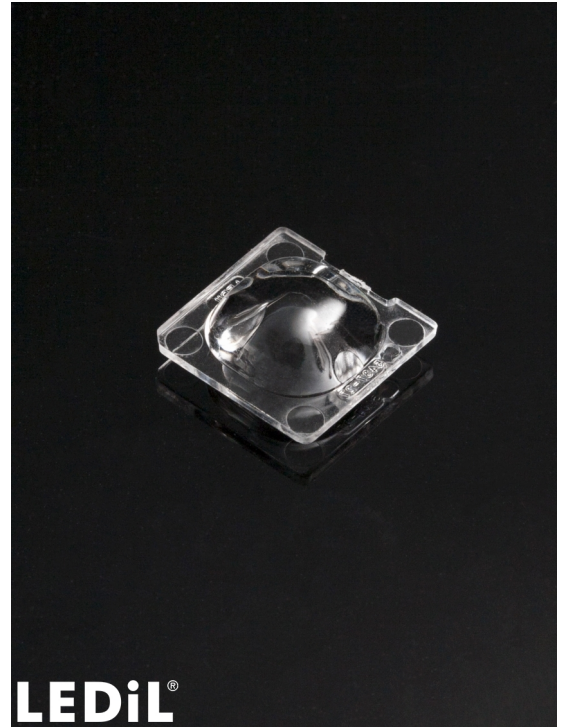

### MATERIALS:

Component	Type	Material	Colour	Finish
STRADELLA-CY	Single lens	PMMA	clear	

### ORDERING INFORMATION:

Component	Qty in box	MOQ	MPQ	Box weight (kg)
C15437_STRADELLA-CY » Box size: 480 x 250 x 390 mm	16000	1000	1000	7.3

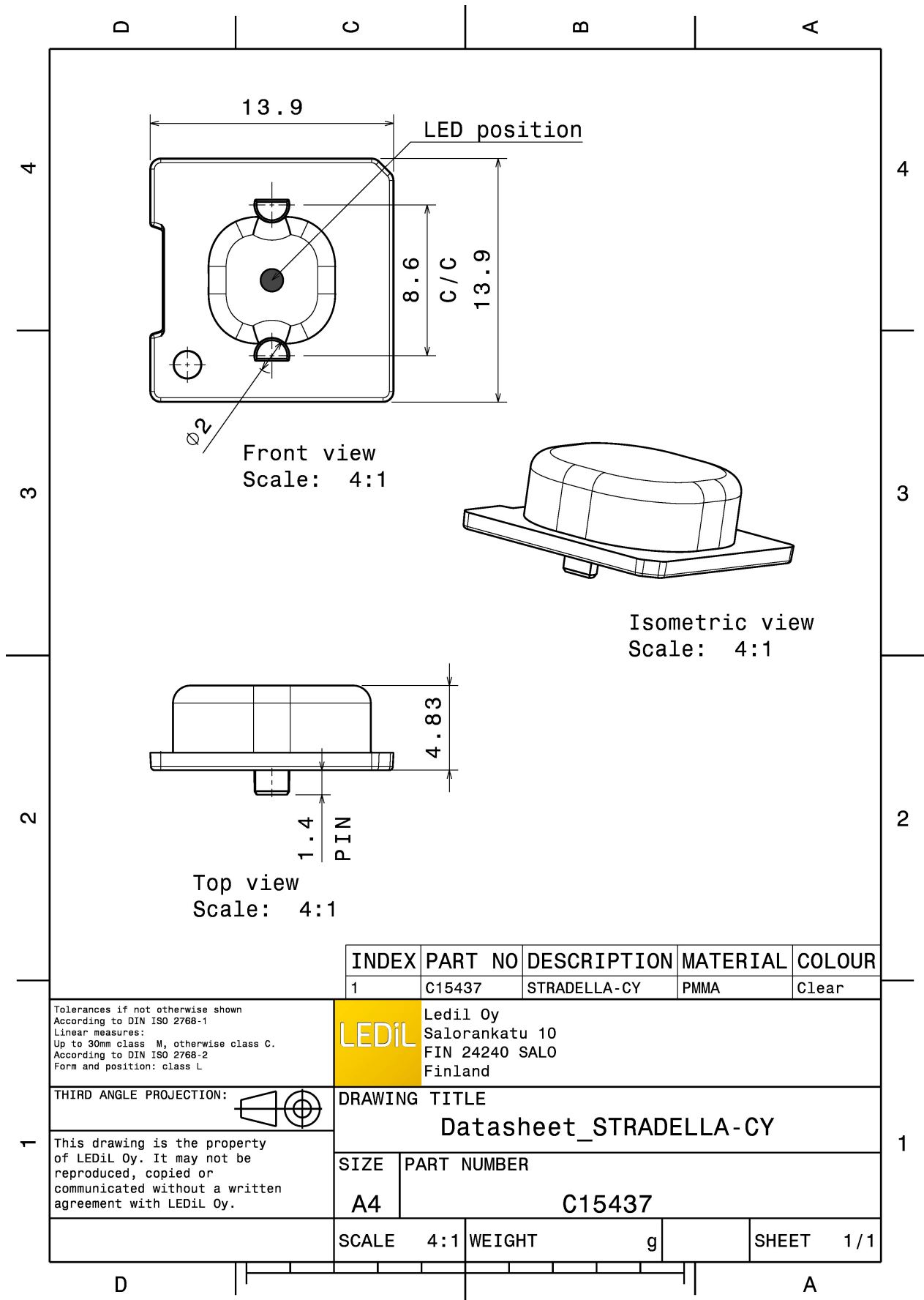

INDEX	PART NO	DESCRIPTION	MATERIAL	COLOUR
1	C15437	STRADELLA-CY	PMMA	Clear

Tolerances if not otherwise shown  
According to DIN ISO 2768-1  
Linear measures:  
Up to 30mm class M, otherwise class C.  
According to DIN ISO 2768-2  
Form and position: class L

**LEDiL** Ledil Oy  
Salorankatu 10  
FIN 24240 SALO  
Finland

THIRD ANGLE PROJECTION:

DRAWING TITLE  
**Datasheet\_STRADELLA-CY**

This drawing is the property of LEDiL Oy. It may not be reproduced, copied or communicated without a written agreement with LEDiL Oy.

SIZE	PART NUMBER
A4	C15437

SCALE	4:1	WEIGHT	g	SHEET	1/1
-------	-----	--------	---	-------	-----

See also our general installation guide: [www.ledil.com/installation\\_guide](http://www.ledil.com/installation_guide)

### OPTICAL RESULTS (MEASURED):

#### CREE LED

LED J Series 3030  
 FWHM / FWTM 118.0° / 133.0°  
 Efficiency 98 %  
 Peak intensity 0.4 cd/lm  
 LEDs/each optic 1  
 Light colour White  
 Required components:

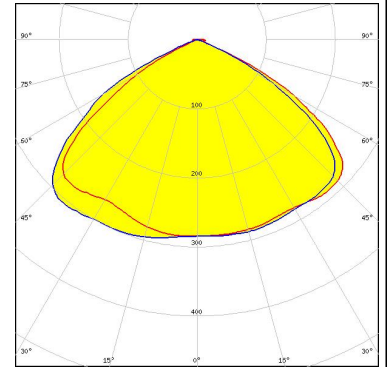

#### CREE LED

LED XT-E  
 FWHM / FWTM 115.0° / 146.0°  
 Efficiency 94 %  
 Peak intensity 0.3 cd/lm  
 LEDs/each optic 1  
 Light colour White  
 Required components:

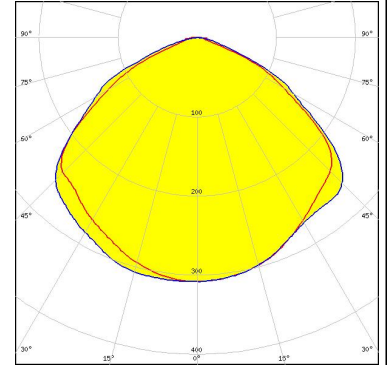

#### NICHIA

LED NVSW219D  
 FWHM / FWTM 114.0° / 134.0°  
 Efficiency 94 %  
 Peak intensity 0.4 cd/lm  
 LEDs/each optic 1  
 Light colour White  
 Required components:

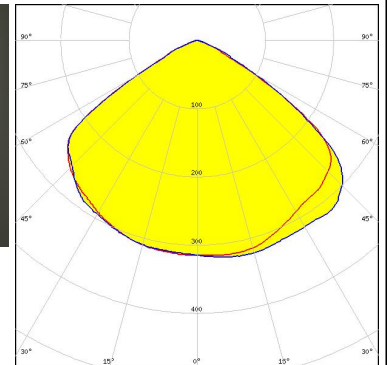
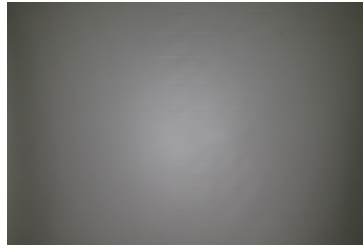

#### NICHIA

LED NVSW319B  
 FWHM / FWTM Asymmetric  
 Efficiency 94 %  
 Peak intensity 0.4 cd/lm  
 LEDs/each optic 1  
 Light colour White  
 Required components:

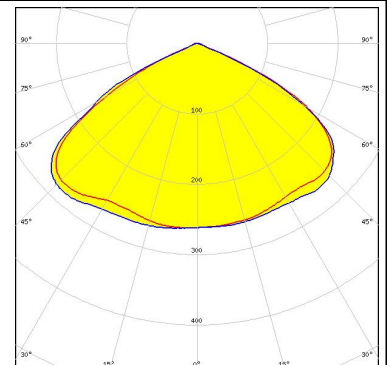

### OPTICAL RESULTS (MEASURED):

#### SAMSUNG

LED LH181B  
FWHM / FWTM 116.0° / 145.0°  
Efficiency 94 %  
Peak intensity 0.4 cd/lm  
LEDs/each optic 1  
Light colour White  
Required components:

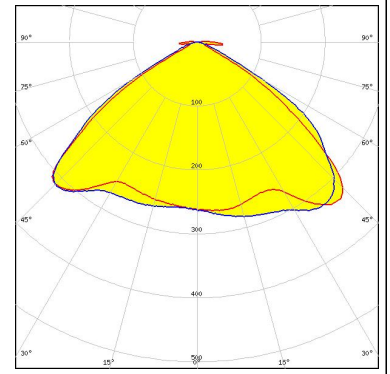

### OPTICAL RESULTS (SIMULATED):

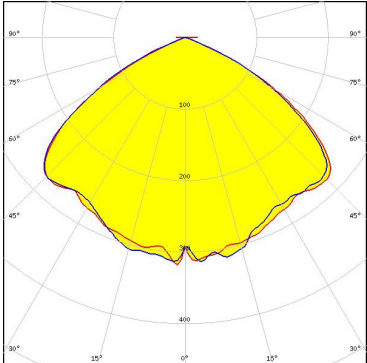
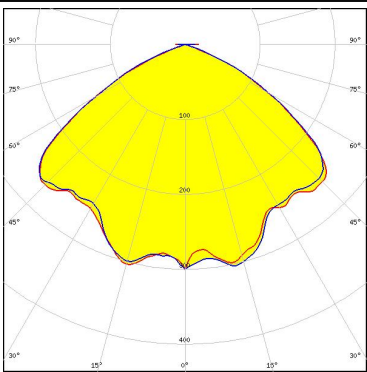
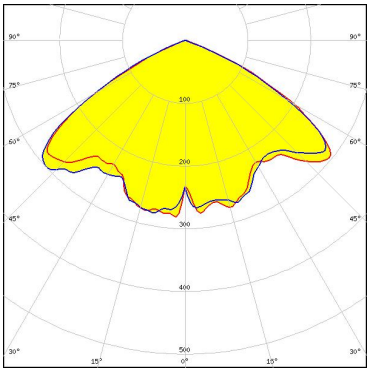
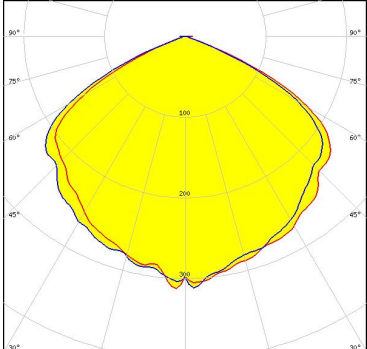
<p><b>CREE</b> → <b>LED</b></p> <p>LED J Series 2835            FWHM / FWTM 117.0° / 135.0°            Efficiency 96 %            Peak intensity 0.4 cd/lm            LEDs/each optic 1            Light colour White            Required components:</p>	
<p><b>CREE</b> → <b>LED</b></p> <p>LED XP-E2            FWHM / FWTM 117.0° / 137.0°            Efficiency 90 %            Peak intensity 0.4 cd/lm            LEDs/each optic 1            Light colour White            Required components:</p> <p style="background-color: #e0f0ff; padding: 2px; display: inline-block;">Protective plate, glass</p>	
<p><b>CREE</b> → <b>LED</b></p> <p>LED XP-E2            FWHM / FWTM 123.0° / 137.0°            Efficiency 96 %            Peak intensity 0.4 cd/lm            LEDs/each optic 1            Light colour Green            Required components:</p>	
<p><b>CREE</b> → <b>LED</b></p> <p>LED XP-G2 HE            FWHM / FWTM 121.0° / 138.0°            Efficiency 95 %            Peak intensity 0.3 cd/lm            LEDs/each optic 1            Light colour White            Required components:</p>	

### OPTICAL RESULTS (SIMULATED):

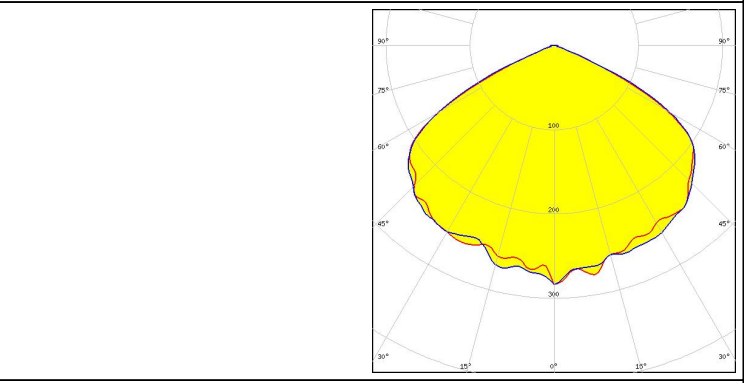
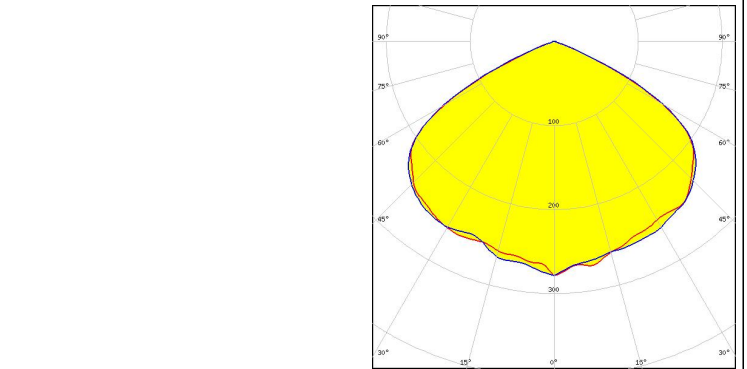
<p><b>LUMILEDS</b></p> <p>LED: LUXEON IR Domed 150            FWHM / FWTM: 131.0° / 142.0°            Efficiency: 96 %            LEDs/each optic: 1            Light colour: IR            Required components:</p>	
<p><b>NICHIA</b></p> <p>LED: NF2W585AR-P8            FWHM / FWTM: 118.0 + 125.0° / 134.0 + 138.0°            Efficiency: 95 %            Peak intensity: 0.4 cd/lm            LEDs/each optic: 1            Light colour: White            Required components:</p>	
<p><b>NICHIA</b></p> <p>LED: NVSW519A            FWHM / FWTM: 122.0° / 136.0°            Efficiency: 92 %            Peak intensity: 0.3 cd/lm            LEDs/each optic: 1            Light colour: White            Required components:</p>	
<p><b>NICHIA</b></p> <p>LED: NVSW519A            FWHM / FWTM: 122.0° / 136.0°            Efficiency: 89 %            Peak intensity: 0.3 cd/lm            LEDs/each optic: 1            Light colour: White            Required components:</p> <p style="background-color: #ADD8E6; padding: 5px; display: inline-block;">Protective plate, glass</p>	

### OPTICAL RESULTS (SIMULATED):

<p><b>OSRAM</b> Opto Semiconductors</p> <p>LED: OSCONIQ C 2424</p> <p>FWHM / FWTM: 120.0° / 135.0°</p> <p>Efficiency: 96 %</p> <p>Peak intensity: 0.4 cd/lm</p> <p>LEDs/each optic: 1</p> <p>Light colour: White</p> <p>Required components:</p>	
<p><b>OSRAM</b> Opto Semiconductors</p> <p>LED: OSCONIQ P 3030</p> <p>FWHM / FWTM: 112.0° / 137.0°</p> <p>Efficiency: 96 %</p> <p>Peak intensity: 0.4 cd/lm</p> <p>LEDs/each optic: 1</p> <p>Light colour: White</p> <p>Required components:</p>	
<p><b>OSRAM</b> Opto Semiconductors</p> <p>LED: OSCONIQ P 3737 (2W version)</p> <p>FWHM / FWTM: 115.0° / 137.0°</p> <p>Efficiency: 94 %</p> <p>Peak intensity: 0.4 cd/lm</p> <p>LEDs/each optic: 1</p> <p>Light colour: White</p> <p>Required components:</p>	
<p><b>OSRAM</b> Opto Semiconductors</p> <p>LED: OSCONIQ P 3737 (3W version)</p> <p>FWHM / FWTM: 117.0° / 143.0°</p> <p>Efficiency: 96 %</p> <p>Peak intensity: 0.3 cd/lm</p> <p>LEDs/each optic: 1</p> <p>Light colour: White</p> <p>Required components:</p>	

### OPTICAL RESULTS (SIMULATED):

#### OSRAM

Opto Semiconductors

LED OSLON Square CSSRM2/CSSRM3  
 FWHM / FWTM 120.0° / 140.0°  
 Efficiency 96 %  
 Peak intensity 0.3 cd/lm  
 LEDs/each optic 1  
 Light colour White  
 Required components:

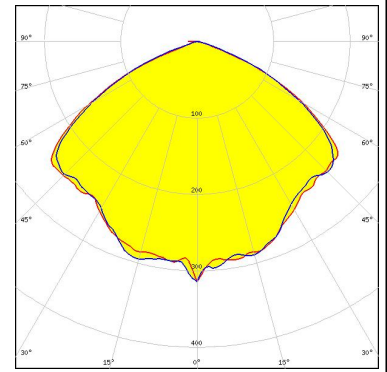

#### SAMSUNG

LED LH351B  
 FWHM / FWTM 110.0° / 118.0°  
 Efficiency 92 %  
 Peak intensity 0.3 cd/lm  
 LEDs/each optic 1  
 Light colour White  
 Required components:

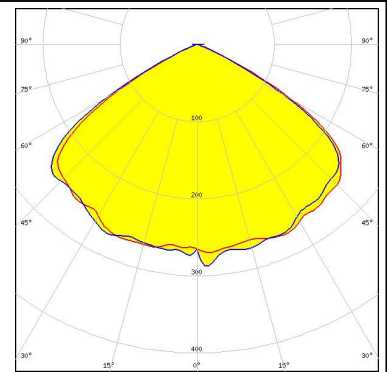

#### SAMSUNG

LED LH351D  
 FWHM / FWTM 123.0° / 135.0°  
 Efficiency 94 %  
 Peak intensity 0.3 cd/lm  
 LEDs/each optic 1  
 Light colour White  
 Required components:

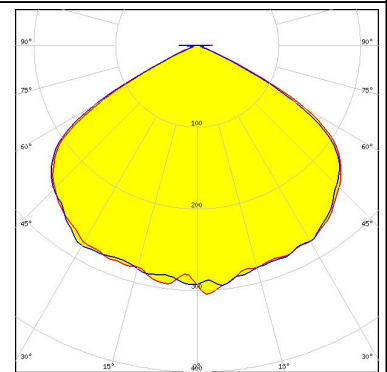

SEOUL SEMICONDUCTOR

LED SEOUL DC 5050 6V  
 FWHM / FWTM 114.0° / 136.0°  
 Efficiency 94 %  
 Peak intensity 0.3 cd/lm  
 LEDs/each optic 1  
 Light colour White  
 Required components:

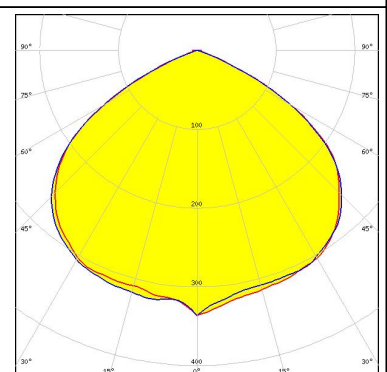



### OPTICAL RESULTS (SIMULATED):



### GENERAL INFORMATION:

NOTE: The typical beam angle will be changed by different color, chip size and chip position tolerance. The typical total beam angle is the full angle measured where the luminous intensity is half of the peak value.

### MATERIALS:

As part of our continuous research and improvement processes, and to ensure the best possible quality and availability of our products, LEDiL reserves the right to change material grades without notice.

### PRODUCT DATA USER AGREEMENT AND DISCLAIMER:

The measured data in the provided downloadable LEDiL Product Datasheets and Mechanical 2D-Drawings is rounded and provided as reference for planning. LEDiL Oy's optical specifications have been verified by conducting performance testing of the products in accordance with the company's quality system. The reported data are averaged results of multiple measurements with typical variation. LEDiL Oy reserves the right to without prior notification make changes and improvements to its products.

LEDiL Oy assumes neither warranty, nor guarantee nor any other liability of any kind for the contents and correctness of the provided data. The provided data has been generated with highest diligence but the provided data may in reality not represent the complete possible variation range of all intrinsic parameters. Therefore, in certain cases a deviation from the provided data could occur.

LEDiL Oy reserves the right to undertake technical changes of its products without further notification which could lead to changes in the provided data. LEDiL Oy assumes no liability of any kind for the possible deviation from any provided data or any other damage resulting from the usage of the provided data.

The user agrees to this disclaimer and user agreement with the download or usage of the provided files.

#### LEDiL Oy

Joensuunkatu 13  
FI-24240 SALO  
Finland

#### LEDiL Inc.

228 West Page Street  
Suite D  
Sycamore IL 60178  
USA

#### Ledil Optics Technology (Shenzhen) Co., Ltd.

# 405 , Block B  
Casic Motor Building  
Shenzhen 518057  
P.R.CHINA

#### Local sales and technical support

[www.ledil.com/  
where\\_to\\_buy](http://www.ledil.com/where_to_buy)

#### Shipping locations

Salo, Finland  
Hong Kong, China

#### Distribution Partners

[www.ledil.com/  
where\\_to\\_buy](http://www.ledil.com/where_to_buy)