

SUGGESTED PANEL CUTOUT

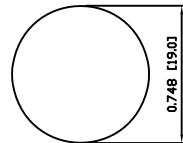

MAXIMUM PANEL THICKNESS: 0.472 [12.0mm]

SCHEMATIC

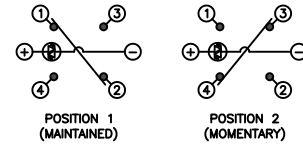

SPECIFICATIONS

FUNCTION:
1PNO OFF-(ON) + 1PNC ON-(OFF)

RATING:
2A 24VDC

ILLUMINATION VOLTAGE:
Forward: 1.8V 20mA
Reverse: 2.8V 20mA

CONTACT RESISTANCE:
Initial: 50mΩ Max. at 1A 12VDC

INSULATION RESISTANCE:
1,000MΩ Min. at 500VDC

DIELECTRIC STRENGTH:
2,000VAC Min. for 1 Minute

ELECTRICAL LIFE:
50,000 Cycles

MECHANICAL LIFE:
1,000,000 Cycles

TEMPERATURE:
Operating: -20°C to 70°C

INGRESS PROTECTION:
IP65

APPROVALS:
RoHS
COMPLIANT

MATERIALS

BUSHING:
Stainless Steel (304)

BASE:
Polycarbonate (PC)

ACTUATOR:
Stainless Steel (304)
Polycarbonate (PC)

HARDWARE:
Nickel Plated Brass (H59)

SEALING:
Silicone Rubber

INNER ASSEMBLY:
Polyoxymethylene (POM)
Polycarbonate (PC)
Brass (H62)

SPRING:
Stainless Steel (Cr18Ni9)

CONTACTS:
Gold Over Silver/Cadmium Oxide (AgCdO)

TERMINALS:
Brass (H62)

O-RING:
Silicone Rubber

COLORS AND FINISH

BEZEL:
Stainless Steel
Machine Finish

ACTUATOR:
Stainless Steel
Machine Finish

ILLUMINATION:
Red (Forward)
Green (Reverse)

MARKING:
None

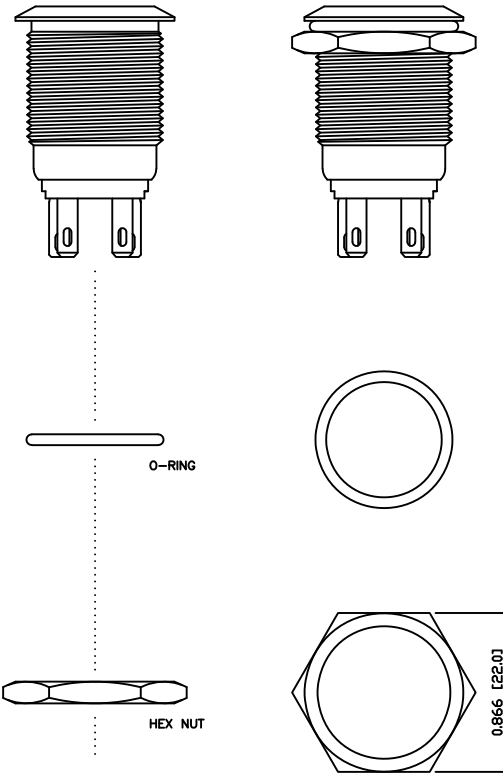

EXPLODED VIEW

ASSEMBLED VIEW

BODY	A	09/07/24	CAB
COLORS	A	09/07/24	CAB
MATERIALS	A	10/03/24	CAB
SPECIFICATIONS	A	10/03/24	CAB
REFERENCE	REV.	DATE	BY

THE INFORMATION CONTAINED IN THIS DOCUMENT IS PROPRIETARY TO E-SWITCH AND IS NOT TO BE COPIED OR TRANSFERRED

B	UPDATED RATING TO 2A @ 24VDC	23599	10/9/18	MJR
A	INITIAL RELEASE	18958	10/03/24	CAB
REV.	DESCRIPTION	PCR	DATE	DRAWN BY

DIMENSIONS	
INCHES [MILLIMETERS]	
GENERAL TOLERANCES	
±0.008 [±0.2] / ±1'	
SCALE	PROJECTION
DRAWING NOT TO SCALE	1st Angle

TITLE		
PV4F2Y0SSG-3G1		
ITEM NUMBER	DATE	REVISION
52-PV4F2Y0SSG3G1	MARCH 24, 2010	B