

Click [here](#) to ask about the production status of specific part numbers.

DS28C40 Evaluation System Lite Version

Evaluates: DS28C40

General Description

The DS28C40 evaluation system (EV system) provides the hardware and software necessary to exercise the features of the DS28C40. The EV system consists of five DS28C40 devices in a 10-pin TDFN package, a DS9121ATB+ evaluation TDFN socket board, and a DS9481P-300# USB-to-I²C/1-Wire[®] adapter. The evaluation software runs under Windows[®] 10, Windows 8, and Windows 7 operating systems, both 64- and 32-bit versions. It provides a handy user interface to exercise the features of the DS28C40.

Features

- Demonstrates the Features of the DS28C40 DeepCover Secure Authenticator
- Logs 1-Wire/I²C Communication to Aid Firmware Designers Understanding of DS28C40
- 1-Wire/I²C USB Adapter Creates a Virtual COM Port on Any PC

- Fully Compliant with USB Specification v2.0
- Software Runs on Windows 10, Windows 8, and Windows 7 for Both 64- and 32-Bit Versions
- 3.3V ±3% I²C Operating Voltage
- Convenient On-Board Test Points, TDFN Socket
- Evaluation Software Available by Request

EV Kit Contents

QTY	DESCRIPTION
5	DS28C40ATB/VY+ DeepCover secure authenticator (10 TDFN)
1	DS9121ATB+ socket board (10 TDFN)
1	DS9481P-300# USB to 1W/I ² C Adapter
1	USB Type-A to USB Mini Type-B cable

Ordering Information appears at end of data sheet.

DS28C40 EV System with a USB Cable

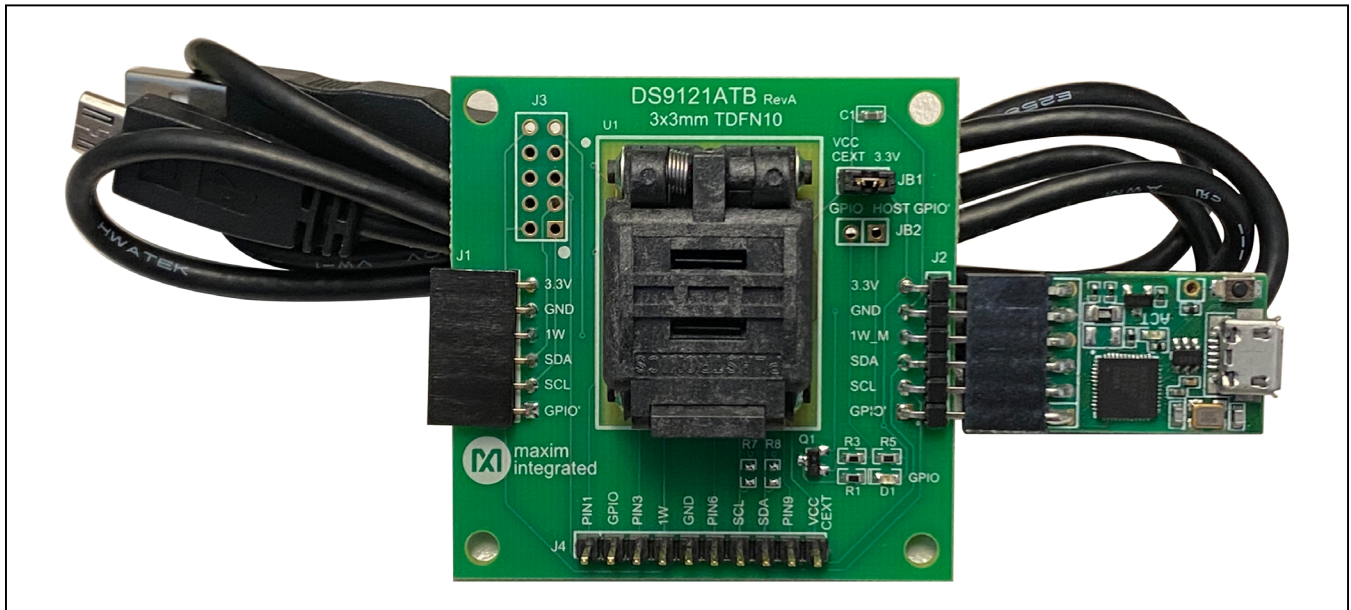

DeepCover is a registered trademark of Maxim Integrated Products, Inc.

Windows is registered trademarks of Microsoft Corp.

Windows is a registered trademark and registered service mark of Microsoft Corporation.

Quick Start

This section is intended to give the DS28C40 evaluator a list of recommended equipment and instructions on how to set up the Windows-based computer for the evaluation software.

Recommended Equipment

- DS9481P-300# USB to 1W/I²C Adapter
- DS9121ATB+ TDFN socket board
- DS28C40ATB/VY+ (five devices included)
- USB Type A-to-USB Micro-Type B cable (included)
- Computer with a Windows 10, Windows 8, or Windows 7 operating system (64- or 32-bit) and a spare USB 2.0 or higher port
- Download DS28C40/DS28C40 EV kit software (light

version) or request full DS28C40/DS28E40 EV kit developer software.

Note: In the following sections, EV kit software related items are identified in **bold**. Windows operating system related items are identified in **bold and underline**.

Hardware Setup and Driver Installation Quick Start

The following steps were performed on a Windows 10 PC to setup the DS28C40 EV kit hardware/software:

- 1) Obtain and unpack **DS28C40_DS28E40_Evaluation_Kit_Lite_Version_Setup** file or newer version.
- 2) In a file viewer, double click on the **DS28C40_DS28E40_Evaluation_Kit_Lite_Version_Setup** to begin the installation.

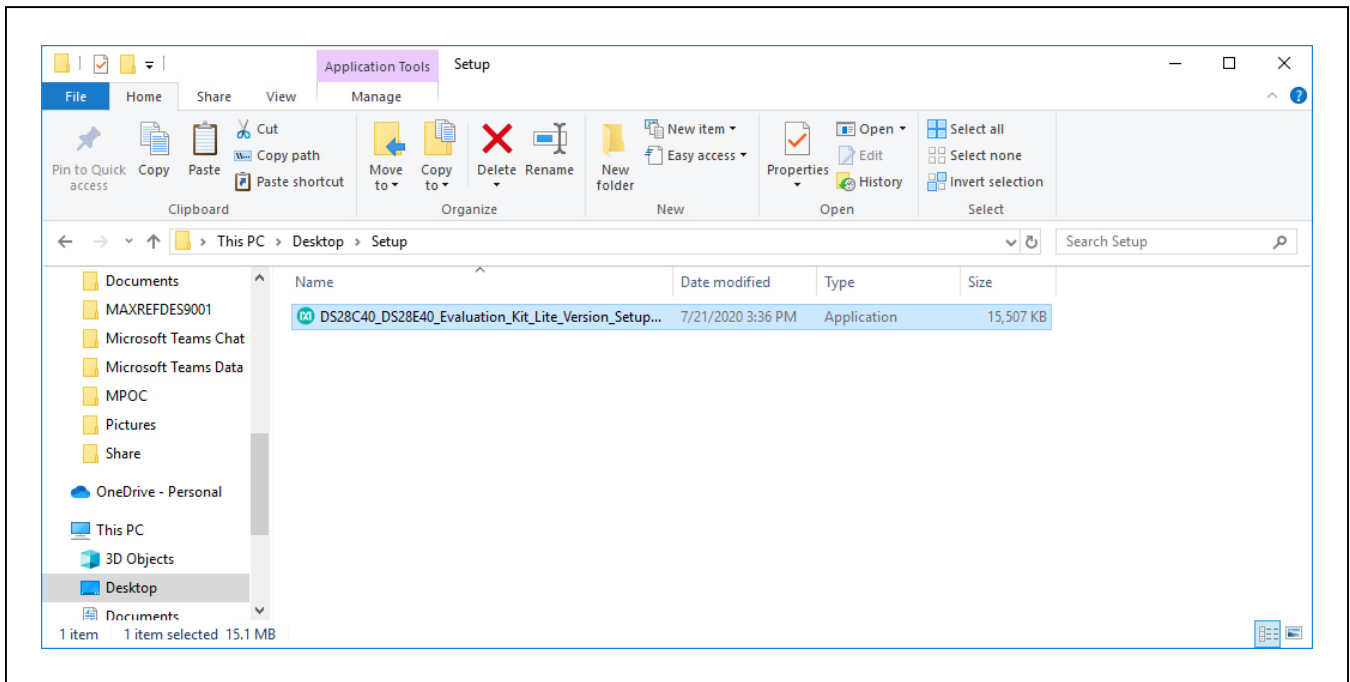

Figure 1. File Viewer

- 3) The setup wizard opens. Click on **Next** (Figure 2):
- 4) Follow the instructions in the wizard and click **Next** to install the EV kit software and required drivers (Figures 3, 4).

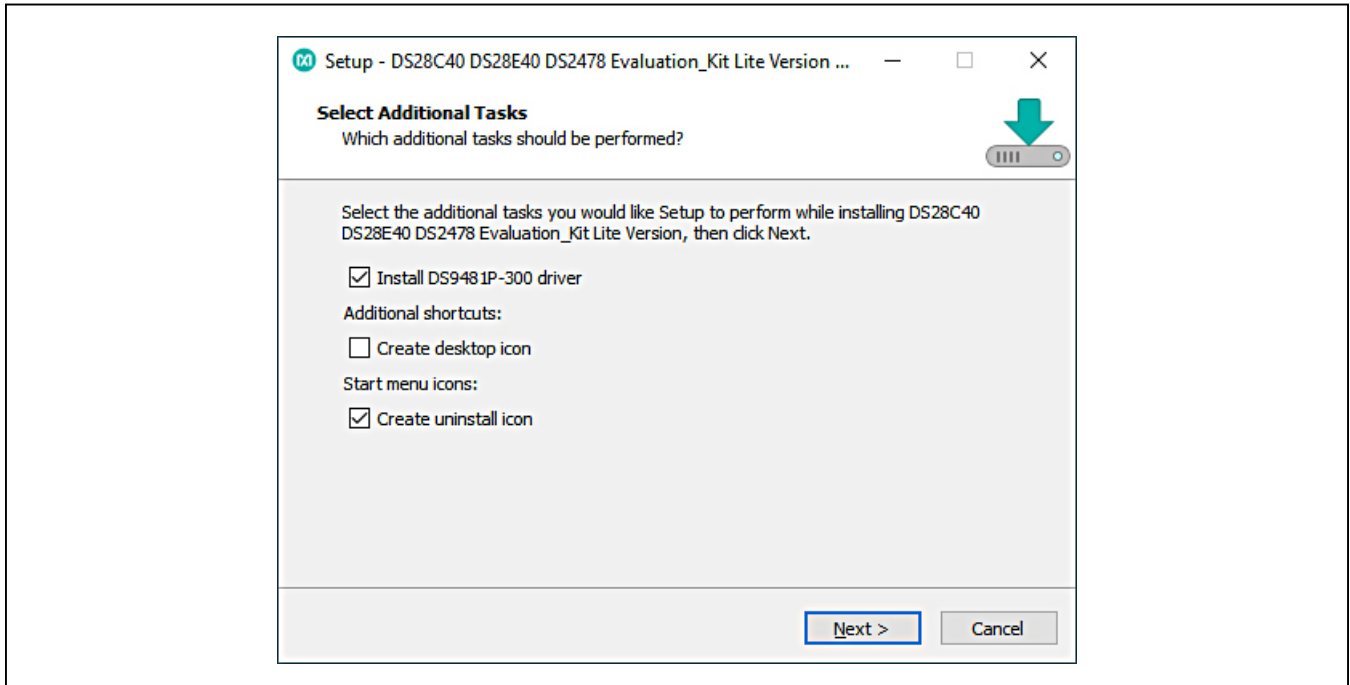

Figure 2. DS28C40 Setup Wizard

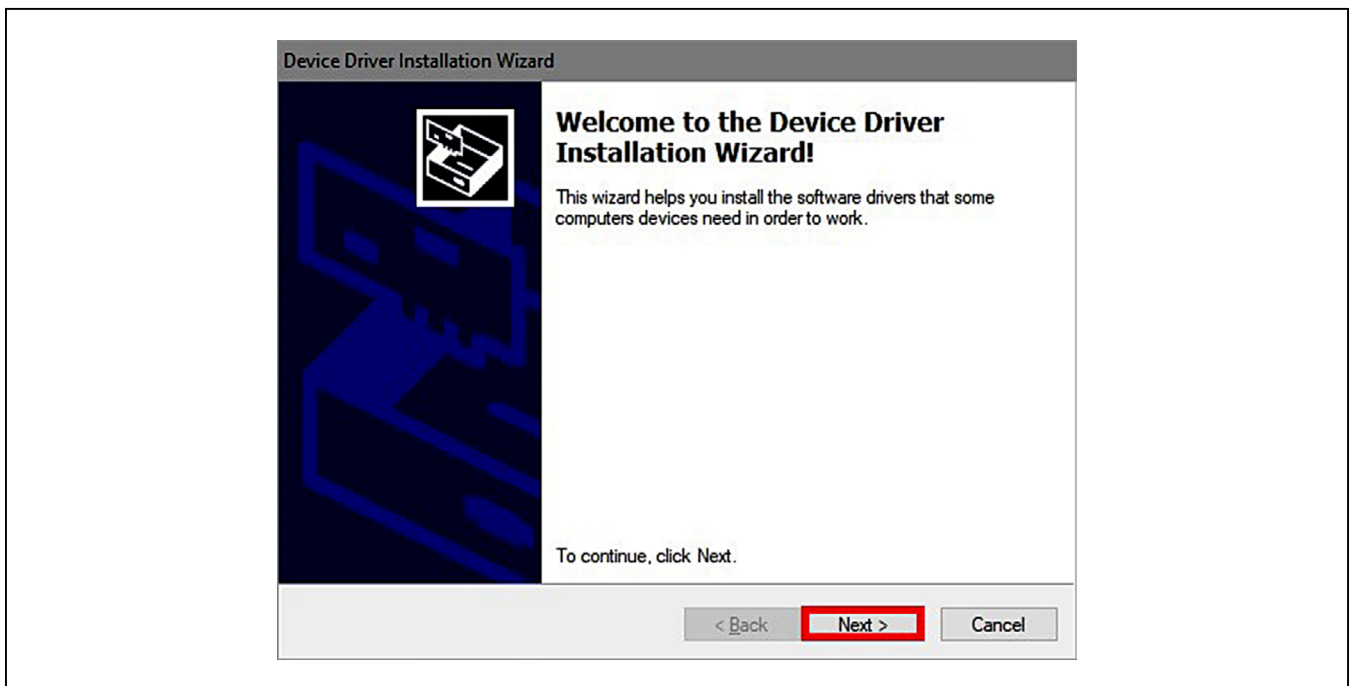

Figure 3. DS9481P-300# Driver Installation

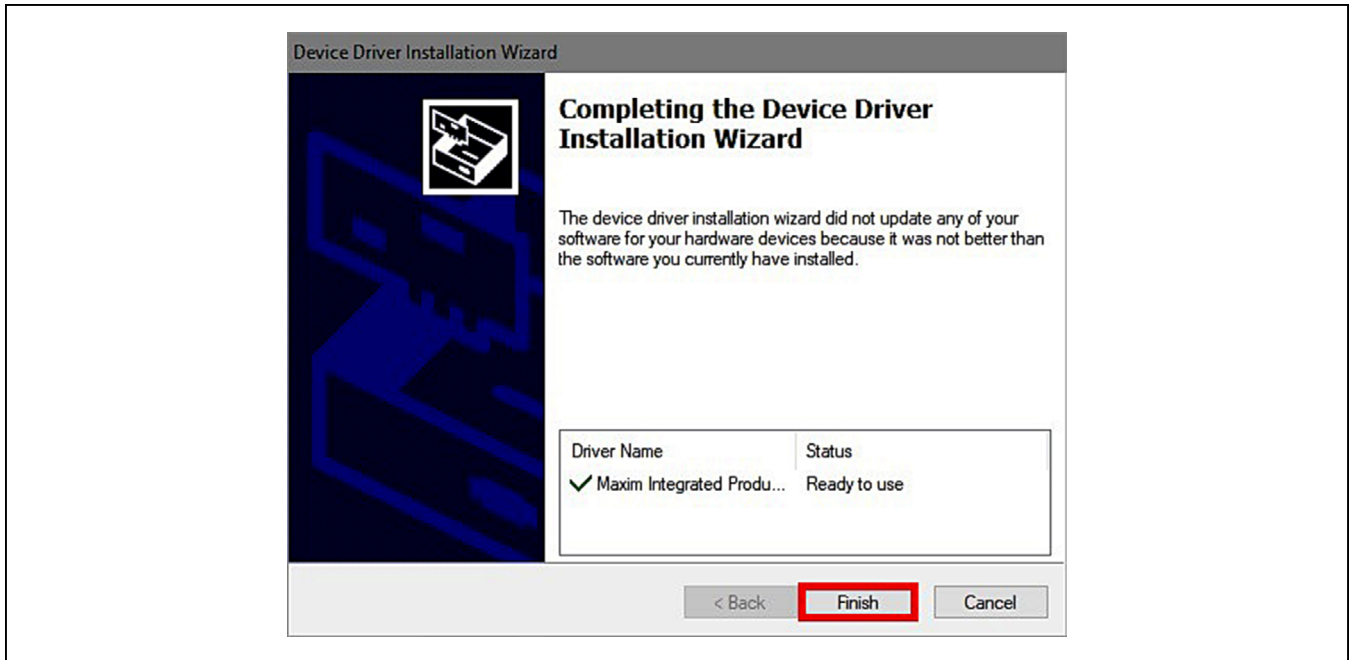

Figure 4. Finish DS9481P-300# Driver Installation

5) Wait for the Installation to complete and launch program if desired after completion, as shown in [Figure 5](#).

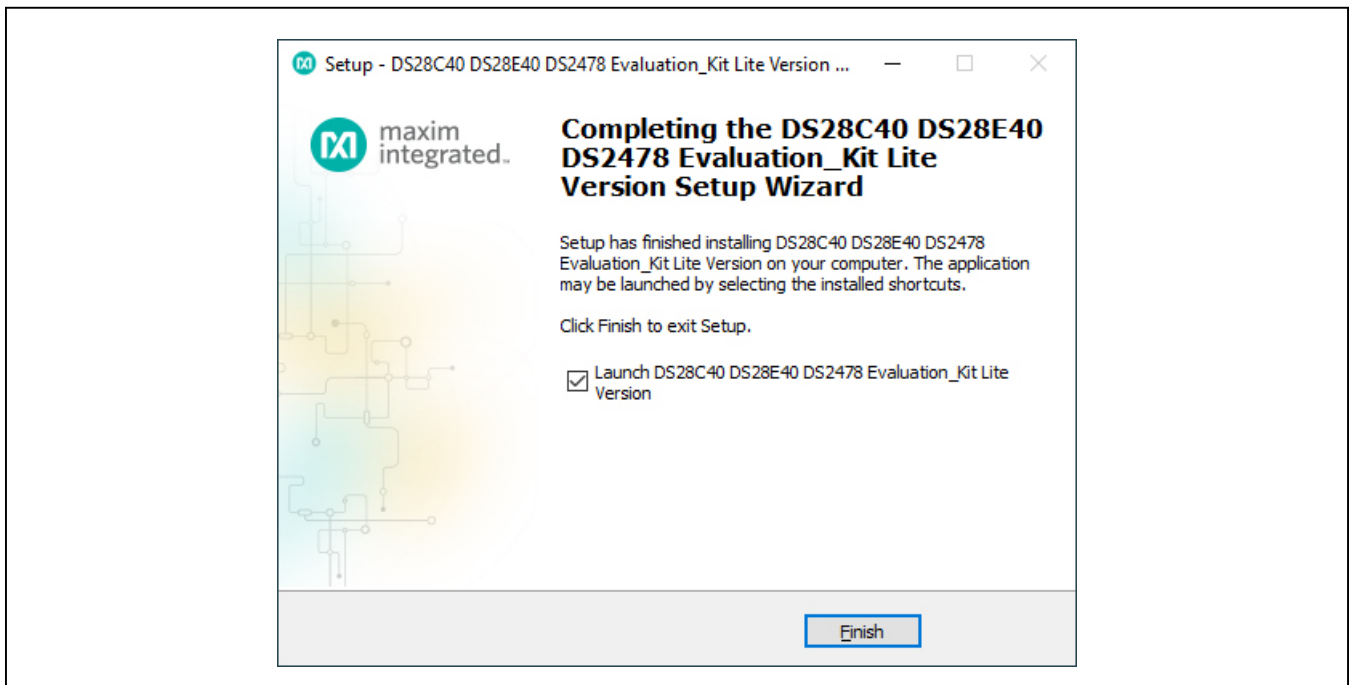

Figure 5. Run Software After Installation

DS28C40 Evaluation System Lite Version

Evaluates: DS28C40

- 6) Plug the DS9481P-300# into the PC with DS9121ATB+ socket board by doing the following:
 - a) Open socket and insert a DS28C40ATB/VY+ as shown in [Figure 6](#). **Note:** The plus (+) on the package must be aligned with the pin 1 marker in the socket. Pin 1 is also marked on the PCB as a white dot located on the top side of the socket's marking.
 - b) Close the socket.
 - c) Connect the DS9121ATB+ J2 6-pin male plug into the DS9481P-300# 6-pin female socket, as shown in [Figure 7](#).
 - d) For the DS9121ATB+, Insert jumper JB1 to use VCC (Figure 7).
 - e) Plug the DS28C40 EV kit, using a USB Type-A to Micro-USB Type-B cable, into the PC.
- 7) The DS28C40 EV kit program opens and automatically connects to the COM port. This can be verified in the lower right corner of the window, as shown in [Figure 8](#).

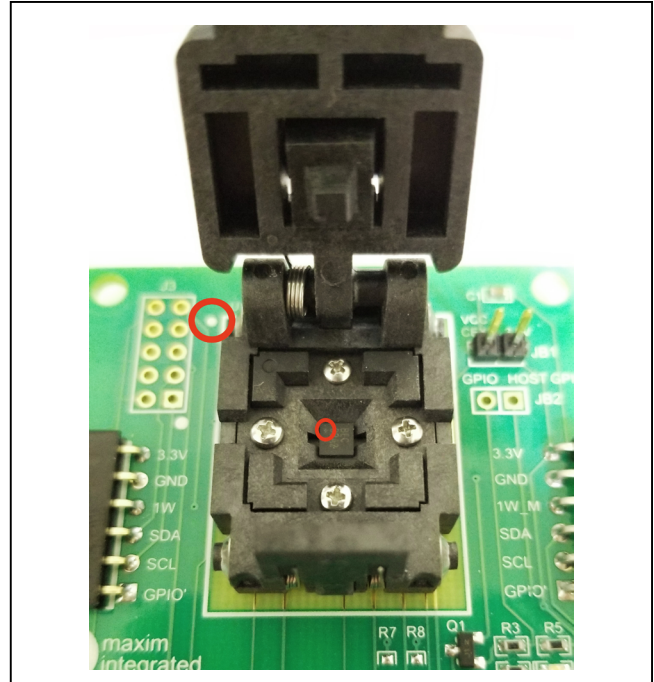

Figure 6. Orientation of the DS28C40 in Burn-in Socket

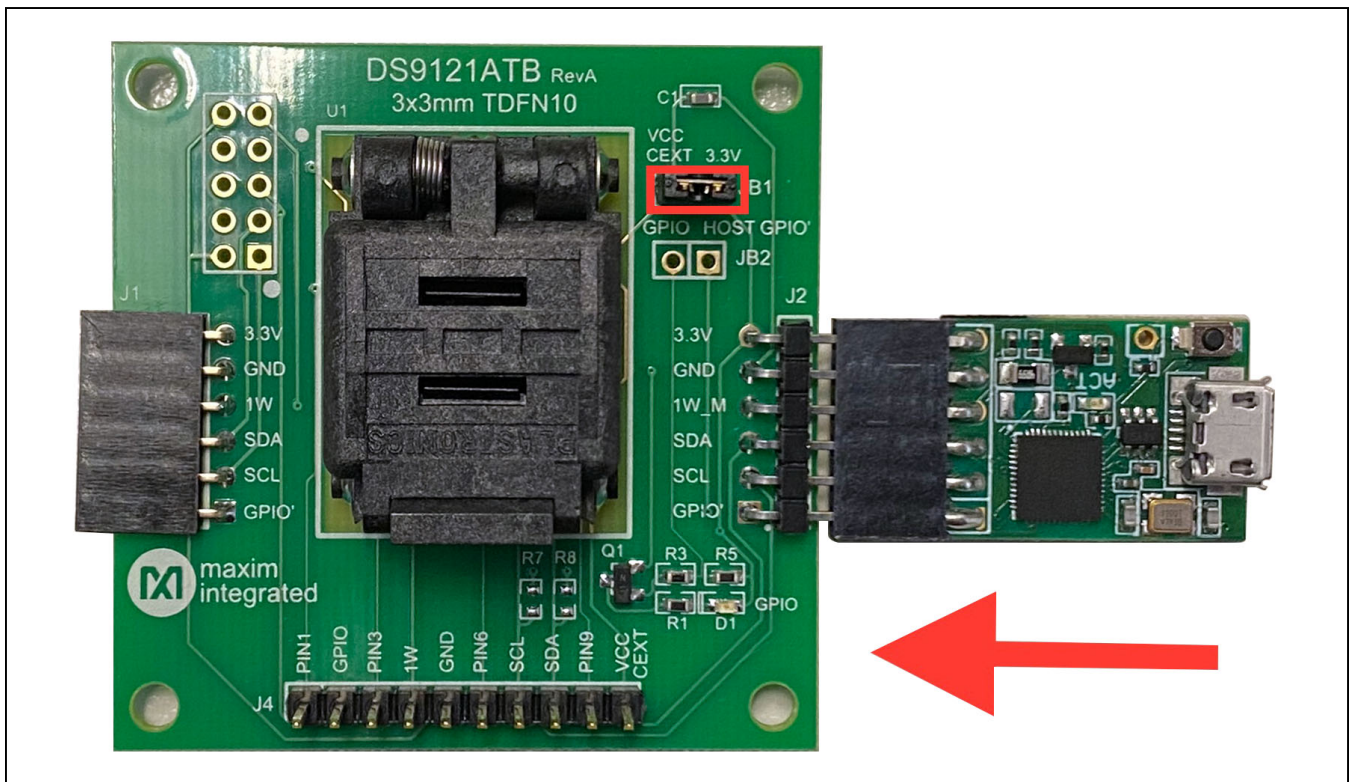

Figure 7. DS9481QA-300 and DS9121ATB

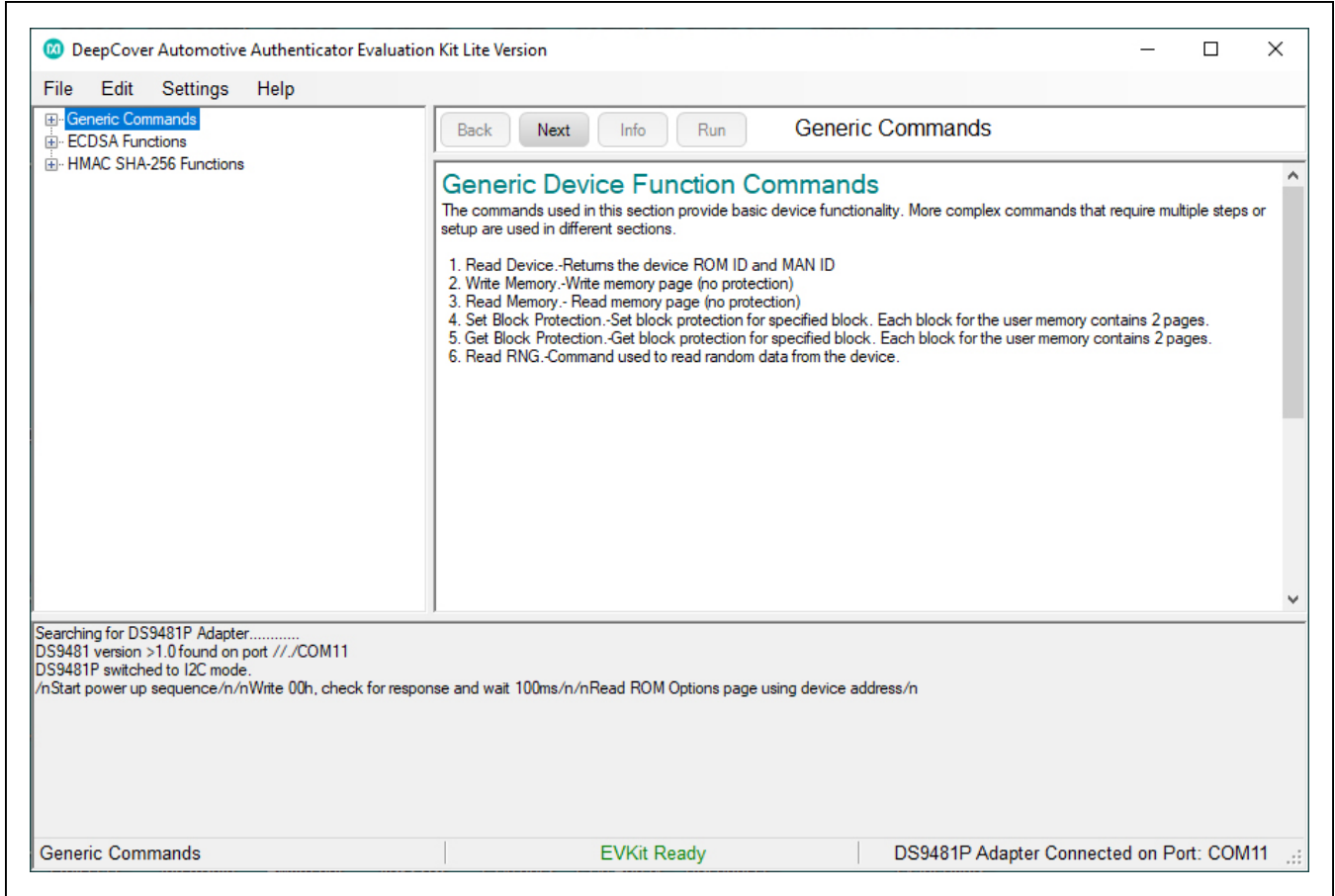

Figure 8. DS28C40 EV Kit Program (Default View Upon Opening)

EV Kit Supported Functions

The DS28C40 EV kit program is designed as a usage example. The GUI optionally displays all the device command sequence transactions as well as SHA and ECDSA computations when Settings→Debug Info is enabled. See [Table 1](#) for descriptions of the functions in the GUI.

Table 1. GUI Setup and Usage Flows Supported

FLOW	DESCRIPTION
Generic Commands	Generic DS28C40 commands without SHA or ECDSA encryption, authentication or protection. (e.g., Read Device, Read and Write Memory, Set and Read Protection and RNG function)
ECDSA Functions*	Examples to set up device for ECDSA authentication, certificate generation and verification. Examples for ECDSA encryption, authentication, signature generation and verification.
HMAC SHA-256 Functions*	Examples provided to setup device for HMAC authentication and verification and for HMAC encryption, authentication and the SHA-256 Generator.

*Available only in full EV Kit Version.

Navigating

The DS28C40 EV Kit Lite Program is divided in four sections: The top menu bar, functions selection, command panel and log.

- **Menu Bar:** Provides access to settings, configuration, hardware selection and other features and information used to support the software operations.
- **Functions Panel:** Access to the device demonstration sequences.
- **Command Panel:** Sequence output, configuration and command execution.
- **Log:** Provides information for command execution, and software operation.

Connection and Detecting Hardware

The DS9481P-300# adapter is connected automatically on software initialization. The adapter can be attached and detected by software later by selecting the adapter connection under **Settings**→**Adapter Port**→**Connect**.

The DS28C40 EV Kit Lite requires the device selection for correct operation and hardware interface.

Select the DS28C40 to start hardware interface by selecting **Settings**→**Select Device**→**DS28C40**.

Ordering Information

PART	TYPE
DS28C40EVKIT#	EV System

#Denotes RoHS compliance.

DS28C40 EV Kit Bill of Materials

DESIGNATION	QTY	DESCRIPTION
Pack-Out	1	I2C AUTHENTICATOR AUTO, EV KIT DS28C40EVKIT#
Pack-Out	5	AUTOMOTIVE I2C AUTHENTICATOR, 6Kb DS28C40ATB/VY+
Pack-Out	1	CABLE, USB A-TO-MICRO-B CABLE (1M) 68784-0001
Pack-Out	1	1W/I2C 3x3MM TDFN SOCKET BOARD DS9121ATB+
Pack-Out	1	DS9481P-300 EVAL KIT# DS9481P-300#
DS9121ATB+ PCB	1	PCB+, DS9121ATB+
J4	1	CONN HEADER VERT 10POS 2.54MM 22284103
J2	0.1	CONN+,HEADER,50PS, 100 SGL, R/A, AU TSW-150-08-G-S-RA
J1	1	CONN+, RCPT, 100" 6POS, R/A GOLD PPPC061LGBN-RC
U1	1	SOCKET+, IC, TDFN10, 3x3MM, CLAMSHELL 10QH50A13030

DESIGNATION	QTY	DESCRIPTION
PACK-OUT	1	LABEL BLANK THT-1-423 0.75 X 0.25
PACK-OUT	1	BAG, STATIC SHIELDZIP4X6, W/ESD LO
C1	1	CAP+, 1.5µF, 10%, 10V, X7R, 0603 C1005X5R1A155K050BC
D1	1	LED+,GREEN CLEAR, 3.2V,20MA,0603 598-8081-107F
JB1	0.1	HEADER 36-40 PINS (CUT TO FIT) 22-28-4363
Populate to JB1	1	SHUNT+, LP W/HANDLE 2 POS 30AU 881545-2
Q1	1	MOSFET, N-CH ENHANCEMENT BSS138LT1G
R3	1	3.3KΩ 1% RESISTOR (0603 PB FREE) ERJ-3EKF3301V
R1, R5	2	RES,10KΩ 1% 0603 ERJ-3EKF1002V

DS28C40 EV Kit Schematic

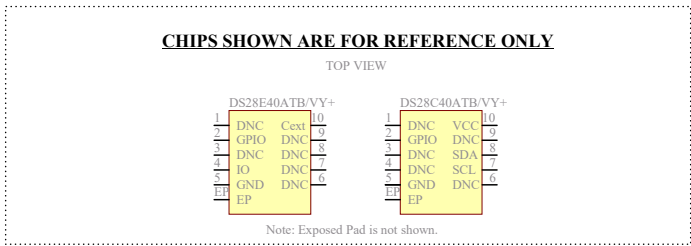
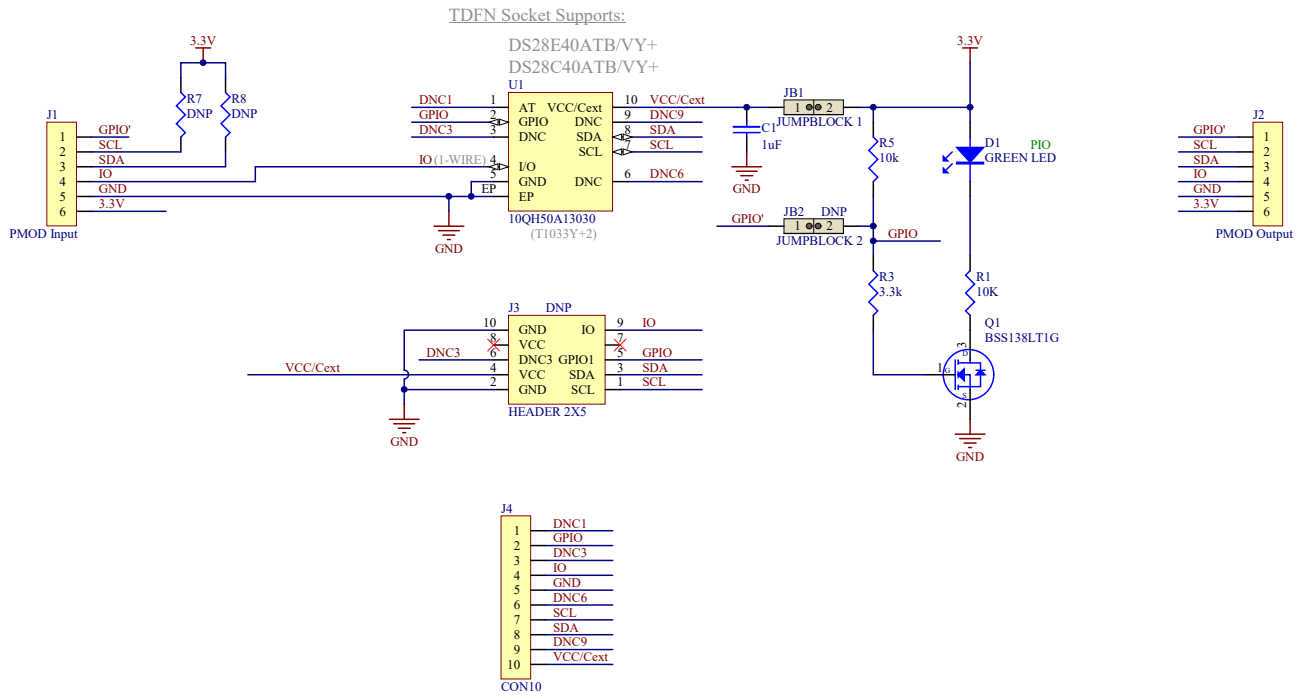
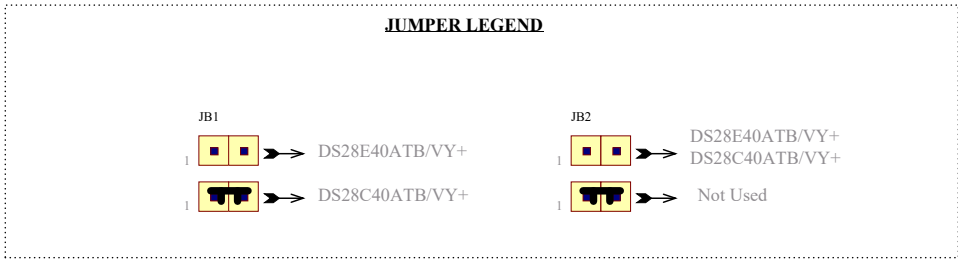

DS28C40 EV Kit PCB Layout Diagrams

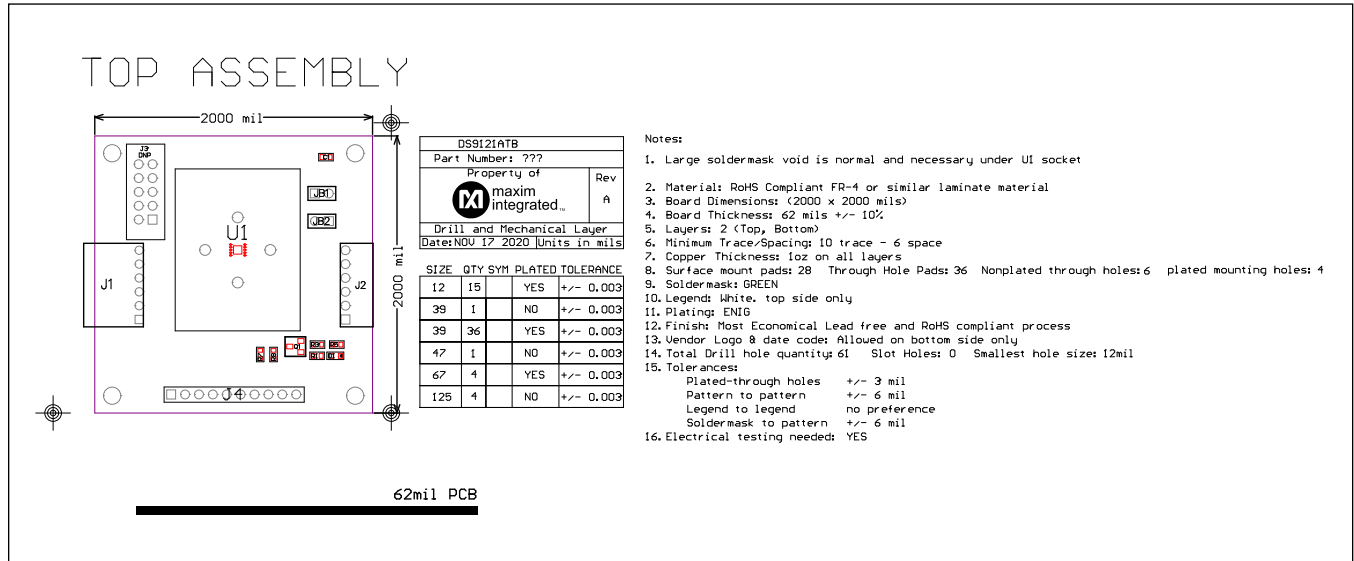

Drill and Mechanical Layer (1 of 5)

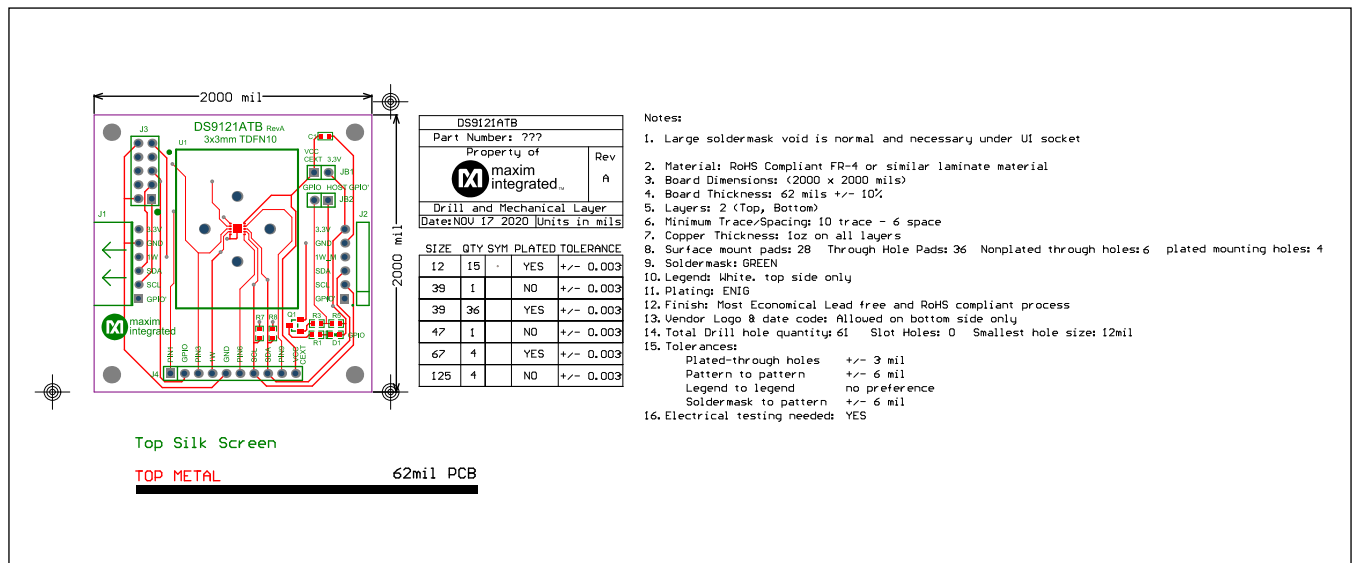

Drill and Mechanical Layer (2 of 5)

DS28C40 EV Kit PCB Layout Diagrams (continued)

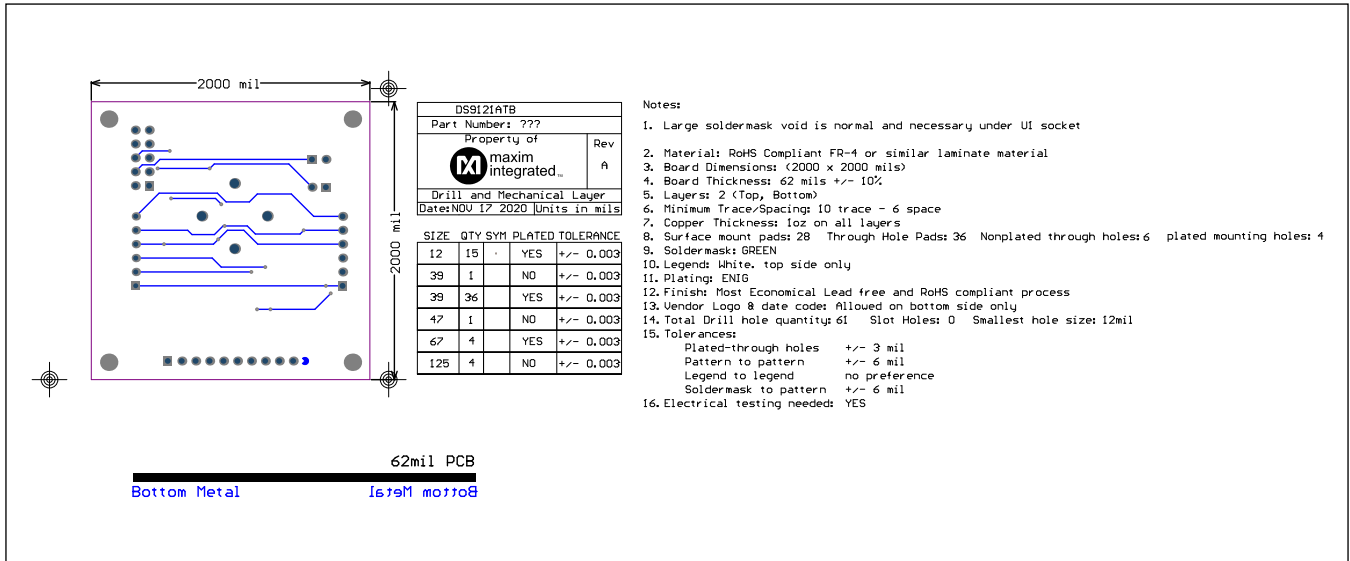

Drill and Mechanical Layer (3 of 5)

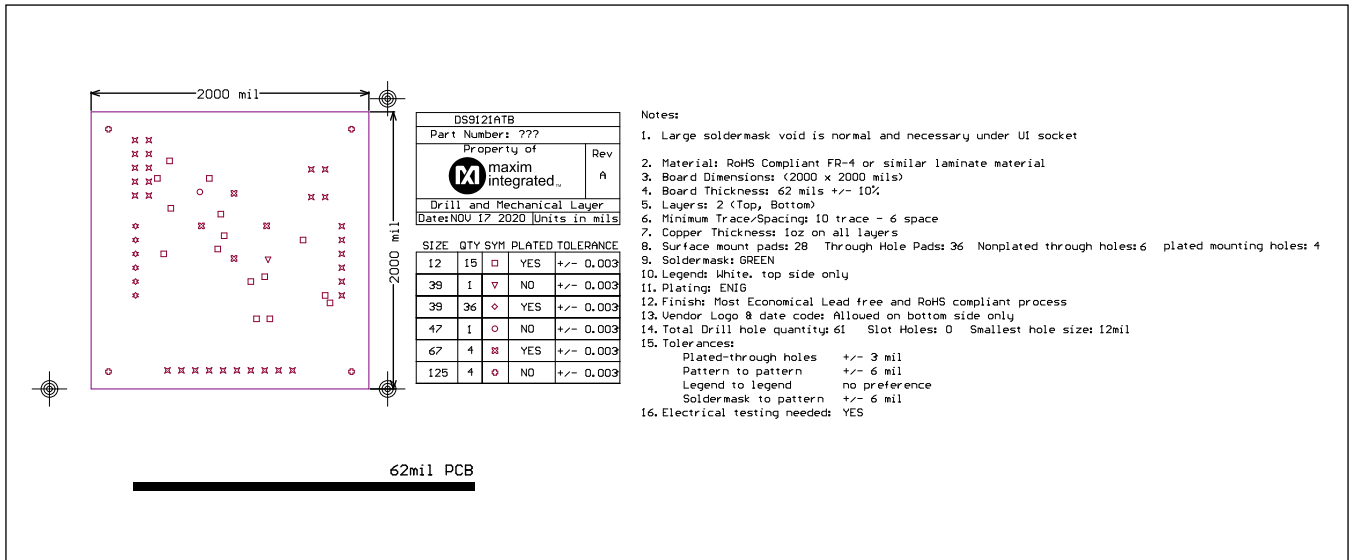

Drill and Mechanical Layer (4 of 5)

DS28C40 EV Kit PCB Layout Diagrams (continued)

DS9121ATB					
Part Number: ???					
Property of					Rev
maxim integrated					A
Drill and Mechanical Layer					
Date: NOV 17 2020 (Units in mils)					
SIZE	QTY	SYM	PLATED	TOLERANCE	
12	15	-	YES	+/- 0.003	
39	1	-	NO	+/- 0.003	
39	36	+	YES	+/- 0.003	
47	1	+	NO	+/- 0.003	
67	4	+	YES	+/- 0.003	
125	4	+	NO	+/- 0.003	

Notes:

1. Large soldermask void is normal and necessary under UI socket
2. Material: RoHS Compliant FR-4 or similar laminate material
3. Board Dimensions: (2000 x 2000 mils)
4. Board Thickness: 62 mils +/- 10%
5. Layers: 2 (Top, Bottom)
6. Minimum Trace/Spacing: 10 trace - 6 space
7. Copper Thickness: 1oz on all layers
8. Surface mount pads: 28 Through Hole Pads: 36 Nonplated through holes: 6 plated mounting holes: 4
9. Soldermask: GREEN
10. Legend: White, top side only
11. Plating: ENIG
12. Finish: Most Economical Lead free and RoHS compliant process
13. Vendor Logo & date code: Allowed on bottom side only
14. Total Drill hole quantity: 61 Slot Holes: 0 Smallest hole size: 12mil
15. Tolerances:
 - Plated-through holes +/- 3 mil
 - Pattern to pattern +/- 6 mil
 - Legend to legend no preference
 - Soldermask to pattern +/- 6 mil
16. Electrical testing needed: YES

62mil PCB

Drill and Mechanical Layer (5 of 5)

Revision History

REVISION NUMBER	REVISION DATE	DESCRIPTION	PAGES CHANGED
0	6/19	Initial release	—
1	7/20	Initial release	—
2	2/21	Updated part number from DS28C40G/V+ to DS28C40ATB/VY+, replaced EV system photo and figure 7, updated <i>DS28C40 EV Kit Bill of Materials</i> , <i>DS28C40 EV Kit Schematic</i> , and <i>DS28C40 EV Kit PCB Layout Diagrams</i> sections	1, 2, 5, 8–12
3	3/21	Updated <i>Quick Start</i> , <i>Figure 1</i> , <i>Figure 6</i> , and <i>Figure 8</i>	2, 5, 6

For pricing, delivery, and ordering information, please visit Maxim Integrated's online storefront at <https://www.maximintegrated.com/en/storefront/storefront.html>.

Maxim Integrated cannot assume responsibility for use of any circuitry other than circuitry entirely embodied in a Maxim Integrated product. No circuit patent licenses are implied. Maxim Integrated reserves the right to change the circuitry and specifications without notice at any time.