

Technical Characteristics

Part Number

Han 42DD Signal Kit

Hood	Side Entry
Housing	Double Lever Bulkhead
Material	Die Cast Aluminum
IP / NEMA	IP67 / 4, 4x, 12
Temp Rating	-40 to +125C
Cable Gland	M32 Metal
Cable Diameter	13-20mm / 18-25mm
Insert	Han 42DD, 42+GND
Crimp Terminals	Sold separately Han D Contacts
Mating Cycles	>500
Flammability	V-0

73 10 100 0033

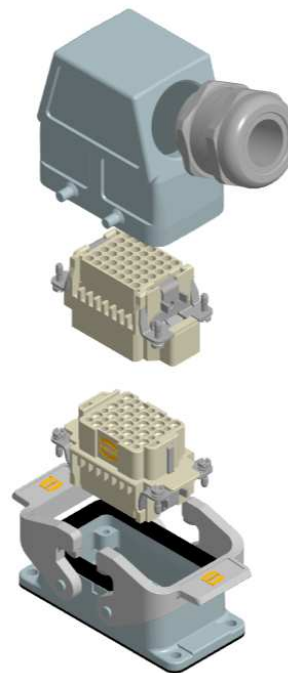

Electrical Characteristics

Rated Current	10A
Rated Voltage	600V
Rated Impulse Voltage	4kV

Drawings and Assembly Information

Dimensions in mm

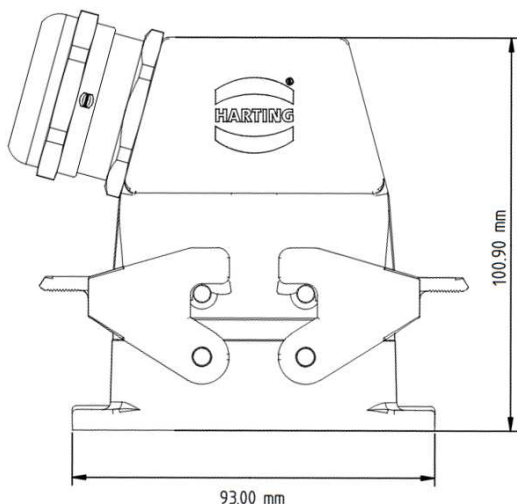

Tooling and Torque Values		
Type	Tool	Torque (Nm)
Fixing Screw (M3)	PH2 or Slotted 0.6 x 3.5	0.50
Mounting Screws (M4 recommended)	-	0.8...1.0
Cable Gland (M32)	SW 40	15

Crimp Contacts			Tooling	
AWG	Male	Female	Crimp Tool	Removal Tool
26-22	09 15 000 6107	09 15 000 6207	09 99 000 0888*	09 99 000 0012
20	09 15 000 6103	09 15 000 6203		
18	09 15 000 6102	09 15 000 6202		
16	09 15 000 6101	09 15 000 6201		
14	09 15 000 6106	09 15 000 6206		

*Alternative tooling options available

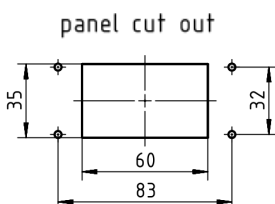

Kit Contents	
Male Insert	09 16 042 3001
Female insert	09 16 042 3101
Housing	09 30 010 1301
Hood	19 30 010 0527
Cable Gland	19 00 000 5095

Guide pins and bushings recommended
09 33 000 9908 & 09 33 000 9909

For further information, please reach out to techsupportUS@HARTING.com