

Feed-through header - MC 1,5/15-G-3,5 - 1844346

Please be informed that the data shown in this PDF Document is generated from our Online Catalog. Please find the complete data in the user's documentation. Our General Terms of Use for Downloads are valid (<http://phoenixcontact.com/download>)

PCB headers, nominal current: 8 A, number of positions: 15, pitch: 3.5 mm, color: green, contact surface: Tin, mounting: Wave soldering



The figure shows a 10-position version of the product

Your advantages

- Well-known mounting principle allows worldwide use
- Maximum flexibility when it comes to device design – one header for connectors with different connection technologies

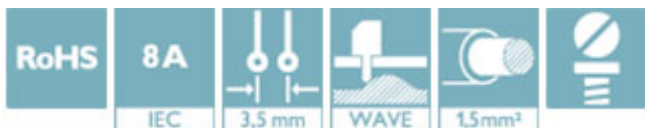

Key Commercial Data

Packing unit	50 pc
GTIN	 4 017918 113384
GTIN	4017918113384

Technical data

Dimensions

Length [l]	9.2 mm
Width	53.9 mm
Pitch	3.5 mm
Dimension a	49 mm
Width [w]	53.9 mm
Height [h]	10.65 mm
Height	7.25 mm
Length of the solder pin	3.4 mm
Pin dimensions	0.8 x 0.8 mm
Length	9.2 mm

General

Range of articles	MC 1,5/...-G
-------------------	--------------

Feed-through header - MC 1,5/15-G-3,5 - 1844346

Technical data

General

Insulating material group	IIIa
Rated surge voltage (III/3)	2.5 kV
Rated surge voltage (III/2)	2.5 kV
Rated surge voltage (II/2)	2.5 kV
Rated voltage (III/3)	160 V
Rated voltage (III/2)	160 V
Rated voltage (II/2)	250 V
Connection in acc. with standard	EN-VDE
Nominal current I _N	8 A
Maximum load current	8 A
Insulating material	PBT
Flammability rating according to UL 94	V0
Color	green
Number of positions	15

Standards and Regulations

Connection in acc. with standard	EN-VDE
	CSA
Flammability rating according to UL 94	V0

Environmental Product Compliance

China RoHS	Environmentally friendly use period: unlimited = EFUP-e
	No hazardous substances above threshold values

Drawings

Feed-through header - MC 1,5/15-G-3,5 - 1844346

Drilling diagram

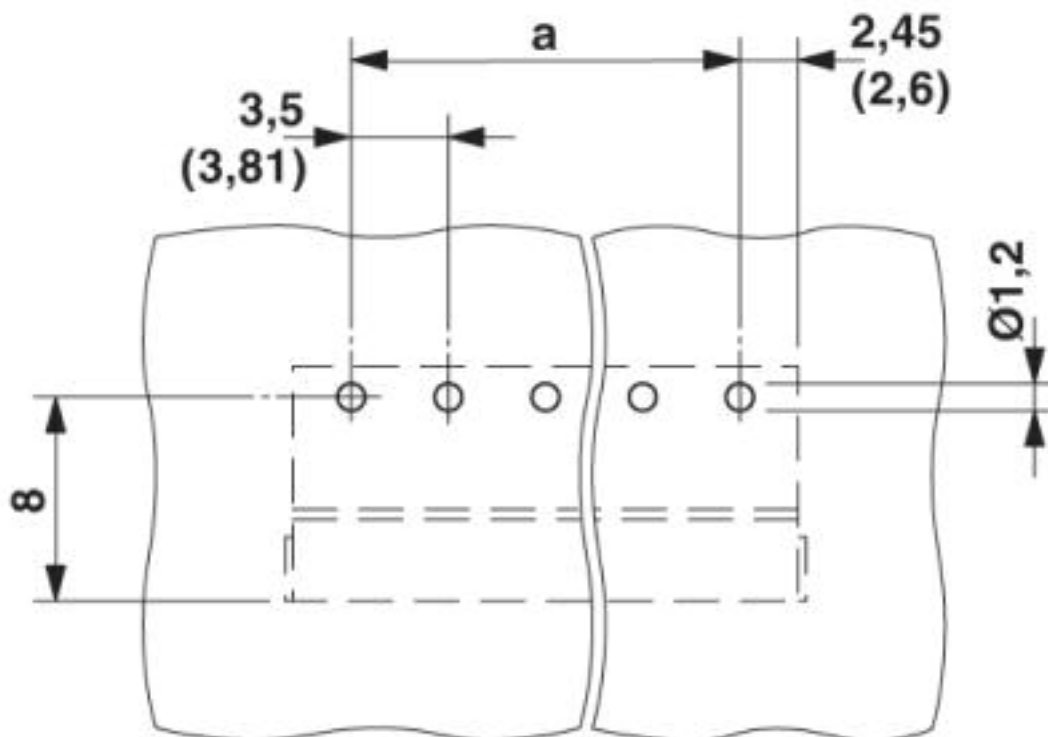

Diagram

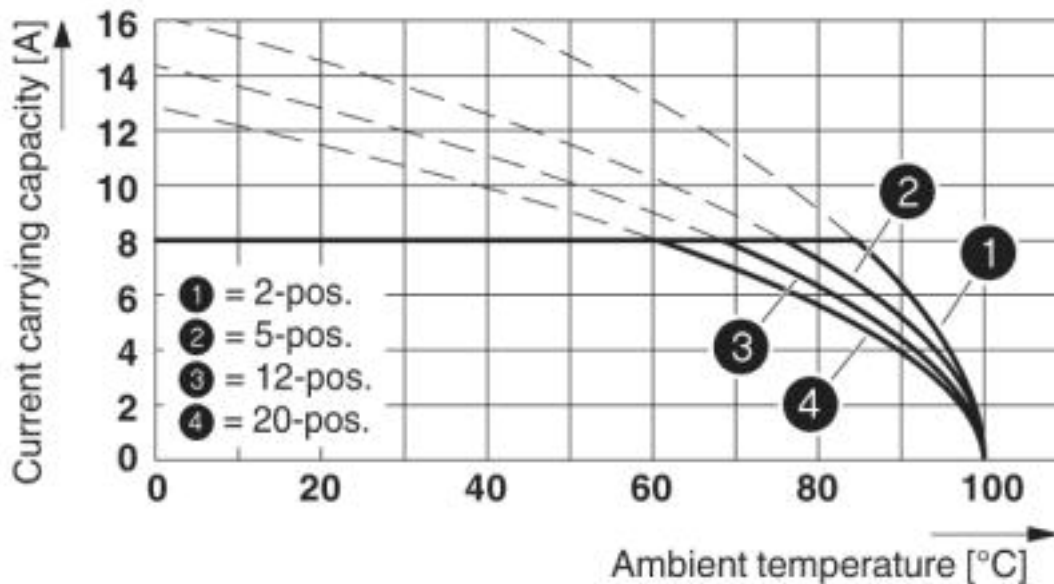

Feed-through header - MC 1,5/15-G-3,5 - 1844346

Diagram

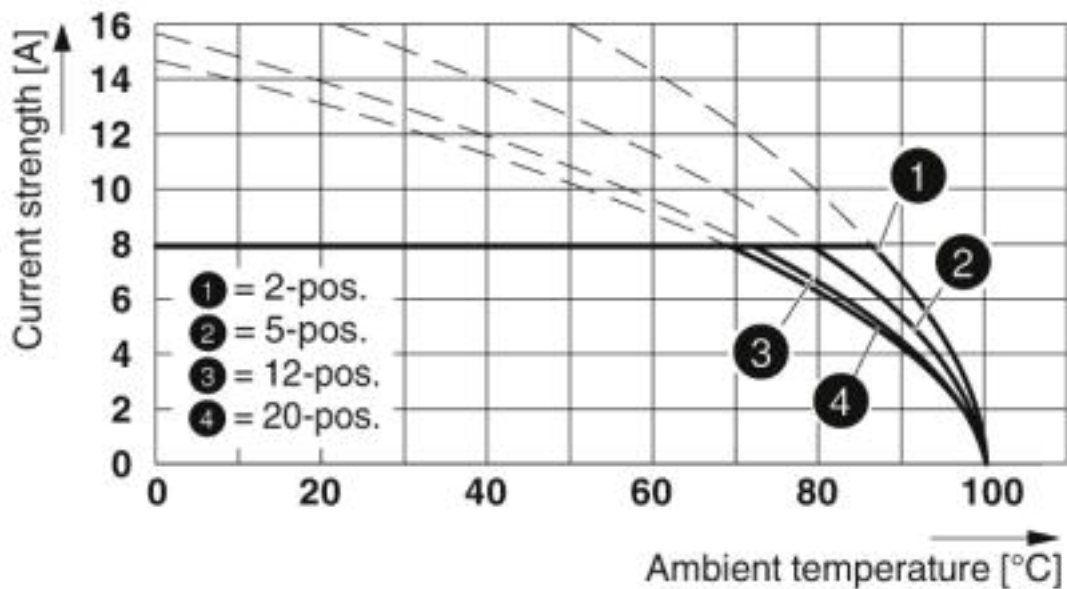

Type: MC 1,5/...-ST-3,5 with MC 1,5/...-G-3,5

Diagram

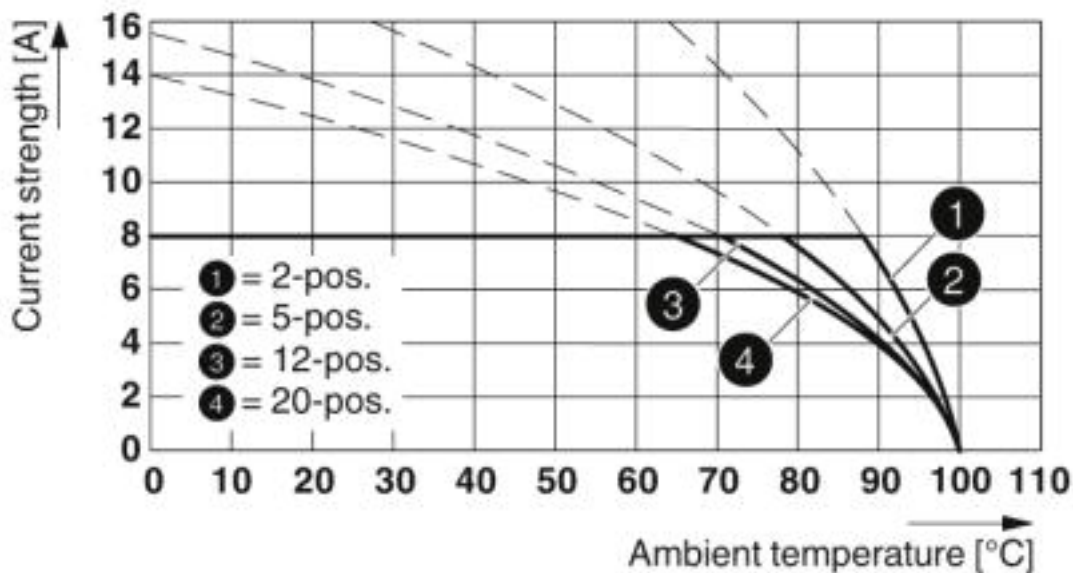

Type: FK-MCP 1,5/...-ST-3,5 with MC 1,5/...-G-3,5

Feed-through header - MC 1,5/15-G-3,5 - 1844346

Diagram

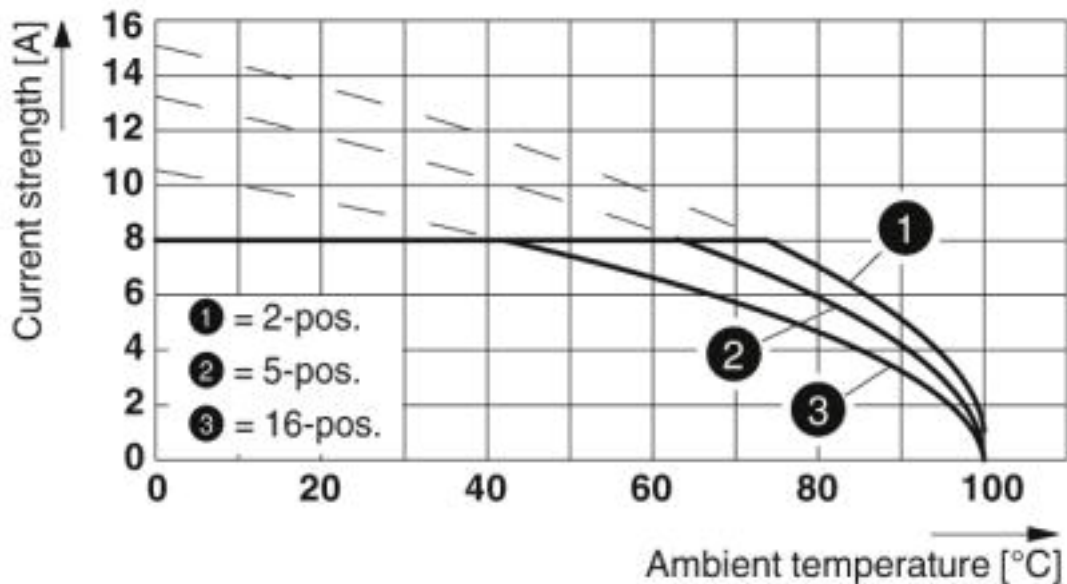

Type: MCVW 1,5/...-ST-3,5 with MC 1,5/...-G-3,5

Dimensional drawing

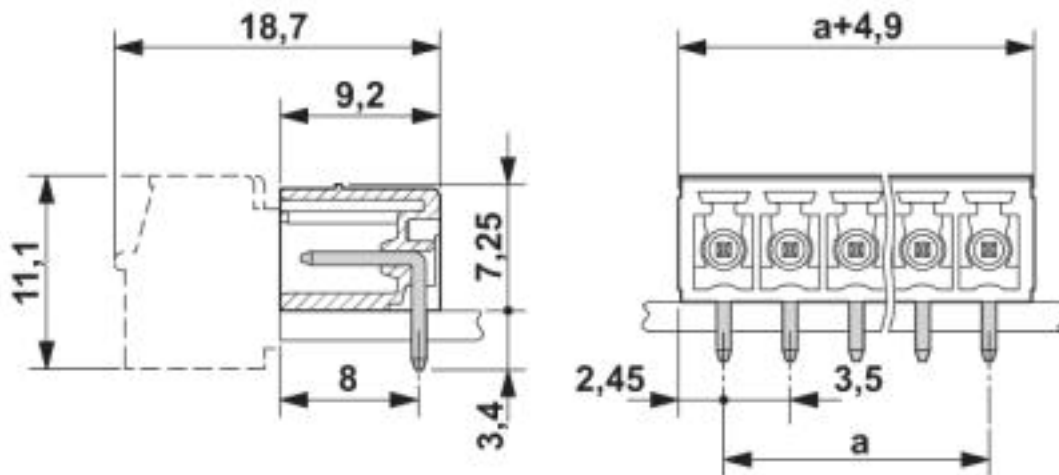

Approvals

Approvals

Approvals

CSA / IECCE CB Scheme / VDE Gutachten mit Fertigungsüberwachung / EAC / cULus Recognized

Ex Approvals

Feed-through header - MC 1,5/15-G-3,5 - 1844346

Approvals

Approval details

CSA		http://www.csagroup.org/services-industries/product-listing/	13631
	B	D	
Nominal voltage UN	300 V	300 V	
Nominal current IN	8 A	8 A	

IECEE CB Scheme		http://www.iecee.org/	DE1-60987-B1B2
Nominal voltage UN	160 V		
Nominal current IN	8 A		

VDE Gutachten mit Fertigungsüberwachung		http://www2.vde.com/de/Institut/Online-Service/VDE-gepruefteProdukte/Seiten/Online-Suche.aspx	40011723
Nominal voltage UN	160 V		
Nominal current IN	8 A		

EAC			B.01742
-----	---	--	---------

cULus Recognized		http://database.ul.com/cgi-bin/XYV/template/LISEXT/1FRAME/index.htm	E60425-20110128
	B	D	
Nominal voltage UN	300 V	300 V	
Nominal current IN	8 A	8 A	

Phoenix Contact 2019 © - all rights reserved
<http://www.phoenixcontact.com>

PHOENIX CONTACT GmbH & Co. KG
Flachmarktstr. 8
32825 Blomberg
Germany
Tel. +49 5235 300
Fax +49 5235 3 41200
<http://www.phoenixcontact.com>