

# SAV8 SERIES ANTI-VANDAL SWITCH

ANTI-VANDAL SWITCHES  
DETECTOR SWITCHES  
DIP SWITCHES  
KEYLOCK SWITCHES  
NAVIGATION SWITCHES  
PUSHBUTTON SWITCHES  
ROCKER SWITCHES  
ROTARY SWITCHES  
SLIDE SWITCHES  
SNAP ACTION SWITCHES  
TACTILE SWITCHES  
TOGGLE SWITCHES  
CAP OPTIONS

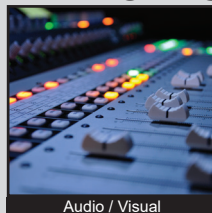

## APPLICATIONS / MARKETS



RoHS

## SPECIFICATIONS

**Electrical Rating:** 15A, 125/250VAC  
**Electrical Life:** 10,000 Cycles  
**Contact Resistance:** 100mΩ max,  
**Insulation Resistance:** 100MΩ @ 500VDC  
**Dielectric Strength:** 1,500VAC for 60 seconds  
**Operating/Storage Temperature:** -25°C to 85°C  
**Travel:** 3.2mm  
**Moisture Protection:** IP67 (at front panel)  
**Actuation Force:** 3.5N  
**Panel Thickness:** 1-10mm  
**Hex Nut Torque:** 1-3Nm

## FEATURES & BENEFITS

- 25mm diameter panel cutout
- Ring or ring/power illumination options
- Multiple illumination voltage options
- Momentary and latching functions
- 15A high current rating

## PART NUMBER CONFIGURATOR

Series	Actuator	Terminal	Function	Body Finish	Actuator Finish	Lens Style	LED Color	Illumination Voltage
SAV8	F - Flat	1 - 4.8mm Quick Connect	3 - 1P ON-ON B - 1P ON-(ON)*	S - Stainless Steel 1 - Black Anodized	S - Stainless Steel 1 - Black Anodized	None - Non-Illuminated 3 - Ring, moveable with actuator 6 - Ring / Power Symbol moveable with actuator	None - Non-Illuminated 0 - White 1 - Red 2 - Orange 3 - Green 4 - Blue 5 - Yellow G - Red / Green P - Green / Yellow	None - Non-Illuminated 1 - 3V 3 - 6V 4 - 12V 5 - 24V 6 - 110V 7 - 220V

**NOTES:**

\*( ) denotes function is momentary  
 Call us for custom graphic options 800-867-2717

Specifications subject to change without notice 8.14.2019



E-SWITCH®

www.e-switch.com

800.867.2717

1

# SAV8 SERIES ANTI-VANDAL SWITCH

## BODY DIMENSIONS

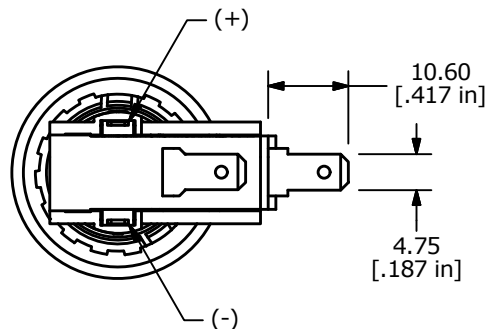
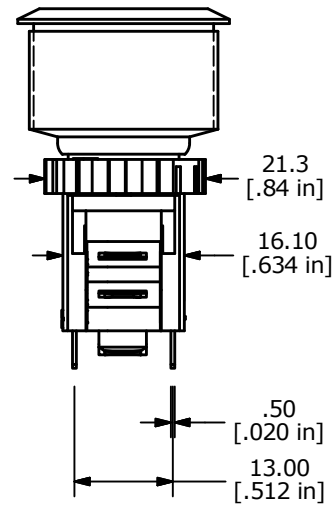
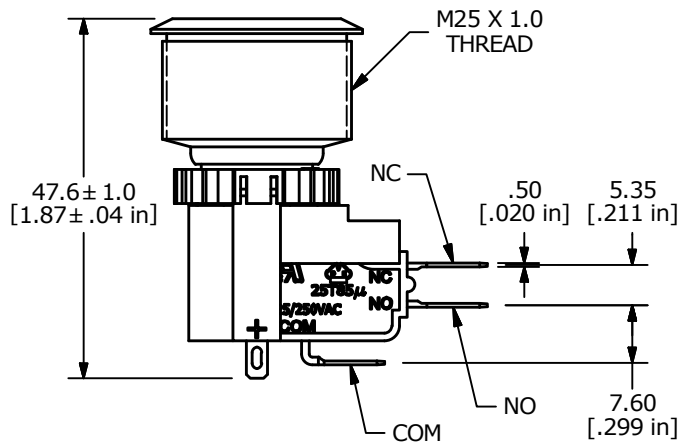
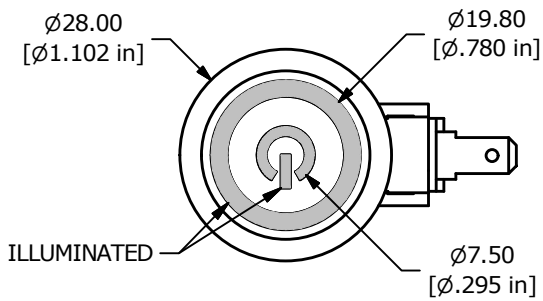
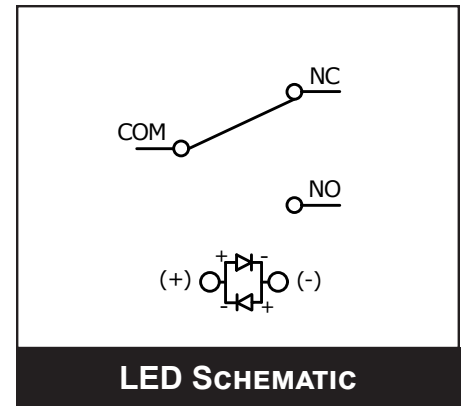
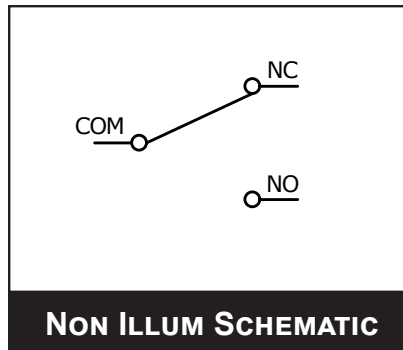
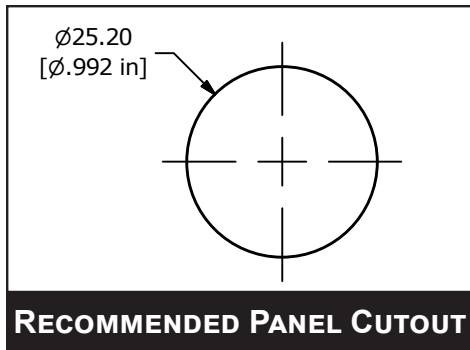

ILLUMINATED RING / POWER SYMBOL OPTION SHOWN

LED (+) AND (-) TERMINALS ARE NOT INCLUDED ON THE NON-ILLUMINATED OPTION



ANTI-VANDAL SWITCHES  
DETECTOR SWITCHES  
DIP SWITCHES  
KEYLOCK SWITCHES  
NAVIGATION SWITCHES  
PUSHBUTTON SWITCHES  
ROCKER SWITCHES  
ROTARY SWITCHES  
SLIDE SWITCHES  
SNAP ACTION SWITCHES  
TACTILE SWITCHES  
TOGGLE SWITCHES  
CAP OPTIONS

# SAV8 SERIES ANTI-VANDAL SWITCH

## LENS STYLE OPTIONS

- ANTI-VANDAL SWITCHES
- DETECTOR SWITCHES
- DIP SWITCHES
- KEYLOCK SWITCHES
- NAVIGATION SWITCHES
- PUSHBUTTON SWITCHES
- ROCKER SWITCHES
- ROTARY SWITCHES
- SLIDE SWITCHES
- SNAP ACTION SWITCHES
- TACTILE SWITCHES
- TOGGLE SWITCHES
- CAP OPTIONS

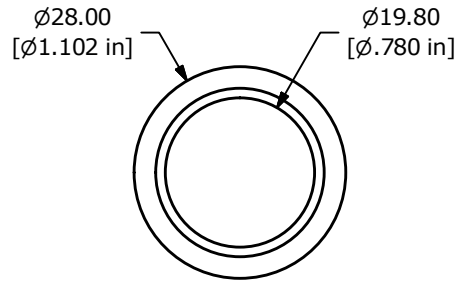

NON-ILLUMINATED

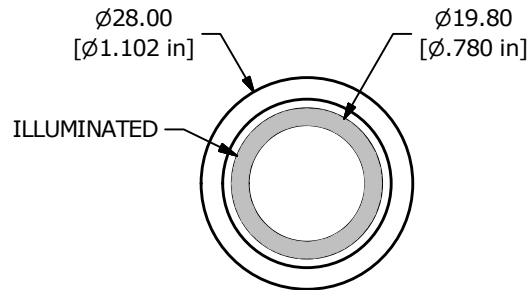

RING ILLUMINATED

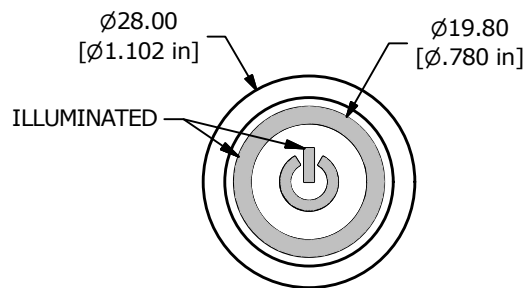

RING / POWER SYMBOL  
ILLUMINATED

