



Energy Harvesting with MB39C811-EVB-02 Evaluation Board Operation Guide

Doc. No. 002-08633 Rev. *B

Cypress Semiconductor
198 Champion Court
San Jose, CA 95134-1709
www.cypress.com

© Cypress Semiconductor Corporation, 2014-2017. This document is the property of Cypress Semiconductor Corporation and its subsidiaries, including Spansion LLC (“Cypress”). This document, including any software or firmware included or referenced in this document (“Software”), is owned by Cypress under the intellectual property laws and treaties of the United States and other countries worldwide. Cypress reserves all rights under such laws and treaties and does not, except as specifically stated in this paragraph, grant any license under its patents, copyrights, trademarks, or other intellectual property rights. If the Software is not accompanied by a license agreement and you do not otherwise have a written agreement with Cypress governing the use of the Software, then Cypress hereby grants you a personal, non-exclusive, nontransferable license (without the right to sublicense) (1) under its copyright rights in the Software (a) for Software provided in source code form, to modify and reproduce the Software solely for use with Cypress hardware products, only internally within your organization, and (b) to distribute the Software in binary code form externally to end users (either directly or indirectly through resellers and distributors), solely for use on Cypress hardware product units, and (2) under those claims of Cypress’s patents that are infringed by the Software (as provided by Cypress, unmodified) to make, use, distribute, and import the Software solely for use with Cypress hardware products. Any other use, reproduction, modification, translation, or compilation of the Software is prohibited.

TO THE EXTENT PERMITTED BY APPLICABLE LAW, CYPRESS MAKES NO WARRANTY OF ANY KIND, EXPRESS OR IMPLIED, WITH REGARD TO THIS DOCUMENT OR ANY SOFTWARE OR ACCOMPANYING HARDWARE, INCLUDING, BUT NOT LIMITED TO, THE IMPLIED WARRANTIES OF MERCHANTABILITY AND FITNESS FOR A PARTICULAR PURPOSE. To the extent permitted by applicable law, Cypress reserves the right to make changes to this document without further notice. Cypress does not assume any liability arising out of the application or use of any product or circuit described in this document. Any information provided in this document, including any sample design information or programming code, is provided only for reference purposes. It is the responsibility of the user of this document to properly design, program, and test the functionality and safety of any application made of this information and any resulting product. Cypress products are not designed, intended, or authorized for use as critical components in systems designed or intended for the operation of weapons, weapons systems, nuclear installations, life-support devices or systems, other medical devices or systems (including resuscitation equipment and surgical implants), pollution control or hazardous substances management, or other uses where the failure of the device or system could cause personal injury, death, or property damage (“Unintended Uses”). A critical component is any component of a device or system whose failure to perform can be reasonably expected to cause the failure of the device or system, or to affect its safety or effectiveness. Cypress is not liable, in whole or in part, and you shall and hereby do release Cypress from any claim, damage, or other liability arising from or related to all Unintended Uses of Cypress products. You shall indemnify and hold Cypress harmless from and against all claims, costs, damages, and other liabilities, including claims for personal injury or death, arising from or related to any Unintended Uses of Cypress products.

Cypress, the Cypress logo, Spansion, the Spansion logo, and combinations thereof, WICED, PSoC, CapSense, EZ-USB, F-RAM, and Traveo are trademarks or registered trademarks of Cypress in the United States and other countries. For a more complete list of Cypress trademarks, visit cypress.com. Other names and brands may be claimed as property of their respective owners.

Preface



This manual explains how to use the evaluation board. Be sure to read this manual before using the product. For this product, please consult with sales representatives or support representatives.

Handling and use

Handling and use of this product and notes regarding its safe use are described in the manuals.

Follow the instructions in the manuals to use this product.

Keep this manual at hand so that you can refer to it anytime during use of this product.

Notice on this document

All information included in this document is current as of the date it is issued. Such information is subject to change without any prior notice.

Please confirm the latest relevant information with the sales representatives.

Cautions



Caution of the products described in this document

The following precautions apply to the product described in this manual.

 WARNING	Indicates a potentially hazardous situation which could result in death or serious injury and/or a fault in the user's system if the product is not used correctly.
--	---

Electric shock, Damage	Before performing any operation described in this manual, turn off all the power supplies to the system. Performing such an operation with the power on may cause an electric shock or device fault.
Electric shock, Damage	Once the product has been turned on, do not touch any metal part of it. Doing so may cause an electric shock or device fault.

 CAUTION	Indicates the presence of a hazard that may cause a minor or moderate injury, damages to this product or devices connected to it, or may cause to lose software resources and other properties such as data, if the device is not used appropriately.
--	---

Cuts, Damage	Before moving the product, be sure to turn off all the power supplies and unplug the cables. Watch your step when carrying the product. Do not use the product in an unstable location such as a place exposed to strong vibration or a sloping surface. Doing so may cause the product to fall, resulting in an injury or fault.
Cuts	The product contains sharp edges that are left unavoidably exposed, such as jumper plugs. Handle the product with due care not to get injured with such pointed parts.
Damage	Do not place anything on the product or expose the product to physical shocks. Do not carry the product after the power has been turned on. Doing so may cause a malfunction due to overloading or shock.
Damage	Since the product contains many electronic components, keep it away from direct sunlight, high temperature, and high humidity to prevent condensation. Do not use or store the product where it is exposed to much dust or a strong magnetic or electric field for an extended period of time. Inappropriate operating or storage environments may cause a fault.
Damage	Use the product within the ranges given in the specifications. Operation over the specified ranges may cause a fault.
Damage	To prevent electrostatic breakdown, do not let your finger or other object come into contact with the metal parts of any of the connectors. Before handling the product, touch a metal object (such as a door knob) to discharge any static electricity from your body.

Damage	When turning the power on or off, follow the relevant procedure as described in this document. Before turning the power on, in particular, be sure to finish making all the required connections. Furthermore, be sure to configure and use the product by following the instructions given in this document. Using the product incorrectly or inappropriately may cause a fault.
Damage	Always turn the power off before connecting or disconnecting any cables from the product. When unplugging a cable, unplug the cable by holding the connector part without pulling on the cable itself. Pulling the cable itself or bending it may expose or disconnect the cable core, resulting in a fault.
Damage	Because the product has no casing, it is recommended that it be stored in the original packaging. Transporting the product may cause a damage or fault. Therefore, keep the packaging materials and use them when re-shipping the product.

Contents



1. Evaluation Board Specification	7
1.1 Description.....	7
1.2 Evaluation Board Specification	7
2. Block Diagram	8
3. PIN Descriptions	9
3.1 Input/Output Pin Descriptions	9
3.2 Jumper, Switch descriptions	10
4. Setup and Verification	11
4.1 Solar (or Light) Energy Harvesting 1	11
4.2 Solar (or Light) Energy Harvesting 2	12
4.3 Vibration Energy Harvesting	13
5. Component and Wiring Layout	15
5.1 Component Layout	15
5.2 Wiring Layout.....	16
6. Circuit Schematic	19
7. Component List	20
8. Evaluation Board Picture	23
9. Ordering Information	25
Revision History	26
Document Revision History	26

1. Evaluation Board Specification



1.1 Description

The MB39C811-EVB-02 is the evaluation board for the energy harvesting IC, MB39C811. This evaluation board is capable of accepting solar, piezoelectric, or any high impedance AC or DC source.

1.2 Evaluation Board Specification

Table 1-1. Evaluation board specification

Parameter	Symbol	Condition	Min	Typ	Max	Unit
Input voltage	VIN	-	2.6	-	18	V
Input slew rate	VIN	$VIN \geq 7V$	-	-	0.25	V/ms
Input current	VIN	-	-	-	100	mA
AC pin input voltage	AC1-1,AC1-2, AC2-1,AC2-2	-	-	-	18	V
AC pin input current	AC1-1,AC1-2, AC2-1,AC2-2	-	-	-	50	mA
Output voltage	VOUT	See Table4-3	1.5	-	5	V
Output current	VOUT	Up to 100mA	-	-	100	mA
UVLO release voltage	VOUT	SW002=L, SW000=L, SW001=L	3.8	4.0	4.2	V
		SW002=L, SW000=L, SW001=H				
		SW002=L, SW000=H, SW001=L				
		SW002=L, SW000=H, SW001=H	4.94	5.2	5.46	V
		SW002=H, SW000=L, SW001=L				
		SW002=H, SW000=L, SW001=H	6.84	7.2	7.56	V
		SW002=H, SW000=H, SW001=L				
SW002=H, SW000=H, SW001=H						
Forward bias voltage	AC1-1,AC1-2, AC2-1,AC2-2	IF=10uA	150	280	450	mV

Please see the MB39C811 datasheet (DS405-00013) for more information.

Board size : 80mm x80mm

2. Block Diagram



Figure 2-1. Block diagram

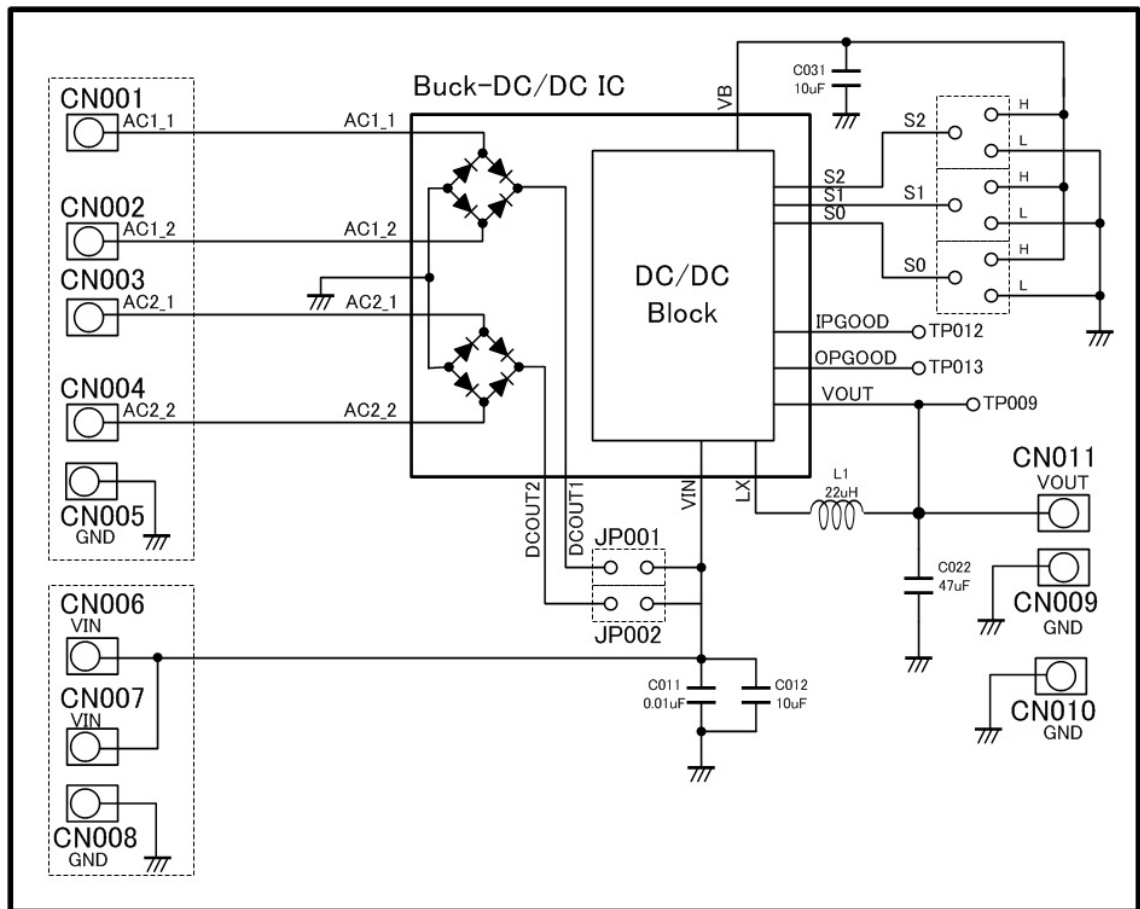

3. PIN Descriptions



3.1 Input/output Pin Descriptions

Table 3-1. Input/output pin descriptions

Pin number	Pin symbol	I/O	Function description
CN001	AC1-1	I	Bridge rectifier 1, AC input 1
CN002	AC1-2	I	Bridge rectifier 1, AC input 2
CN003	AC2-1	I	Bridge rectifier 2, AC input 1
CN004	AC2-2	I	Bridge rectifier 2, AC input 2
CN005	GND	-	GND pin
CN006	VIN	I	DC power input
CN007	VIN	I	It supplies power directly to the VIN pin, and not through the bridge rectifier.
CN008	GND	-	GND pin
CN009	GND	-	GND pin
CN010	GND	-	GND pin
CN011	VOUT	O	VOUT pin
TP005	DCOUT1	O	Bridge rectifier 1, DC monitor pin
TP006	DCOUT2	O	Bridge rectifier 2, DC monitor pins
TP009, TP020	VOUT	O	VOUT monitor pin
TP010	VB	O	VB voltage monitor pin
TP012	IPGOOD	O	Input power good pin
TP013	OPGOOD	O	Output power good pin
TP014~TP019,TP023	GND	-	GND pin
J001	unnecessary	O	AC1-1,AC1-2,AC2-1,AC2-2 monitor pins
J002	unnecessary	O	VOUT, IPGOOD, OPGOOD monitor pins
J003	unused	-	-

3.2 Jumper, Switch descriptions

Table 3-2. Jumper, Switch Descriptions

Jumper, Switch	Function description	Initial setting
JP001 (*1) : EVB back side	Connection jumper between the DC output pin (DCOUT1) of bridge rectifier 1 and DC input pin (VIN) of DC/DC converter to "open/short"	Open
JP002 (*1) : EVB back side	Connection jumper between the DC output pin (DCOUT2) of bridge rectifier 2 and DC input pin (VIN) of DC/DC converter to "open/short"	Open
JP003	Short between AC1-1 lines	Short
JP004	Short between AC1-2 lines	Short
JP005	Short between AC2-1 lines	Short
JP006	Short between AC2-2 lines	Short
JP007	Short between S0 pin and toggle switch	Short
JP008	Short between S1 pin and toggle switch	Short
JP009	Short between S2 pin and toggle switch	Short
JP010 : EVB back side	Short between VOUT and zener diode. VOUT protection (unnecessary)	Short
JP011	Short between VB and zener diode. VB protection (unnecessary)	Short
JP012	Short between LX lines	Short
SW000	High/Low selecting switch for S0. See Table 3-3	L
SW001	High/Low selecting switch for S1. See Table 3-3	L
SW002	High/Low selecting switch for S2. See Table 3-3.	L

*1: Open/Short by soldering

Table 3-3. Output Voltage Settings

S2 pin (SW002)	S1 pin (SW001)	S0 pin (SW000)	Preset output voltage
L	L	L	1.5 (Initial setting)
L	L	H	1.8
L	H	L	2.5
L	H	H	3.3
H	L	L	3.6
H	L	H	4.1
H	L	L	4.5
H	H	H	5.0

4. Setup and Verification



4.1 Solar (or Light) Energy Harvesting 1

1. Set the switches (SW000=L, SW001=L, SW002=L) as shown in the Figure 4-1(see the Table 3-2 for the initial settings).
2. Input 4.0V or more to CN006 or CN007 (VIN). The UVLO release voltage is required to start up (see the Table 1-1).
3. 1.5V is output to CN011 (VOUT).
4. To change the output voltage, change the switch settings (see the Table 3-3)

Figure 4-1. Solar (or light) energy harvesting 1

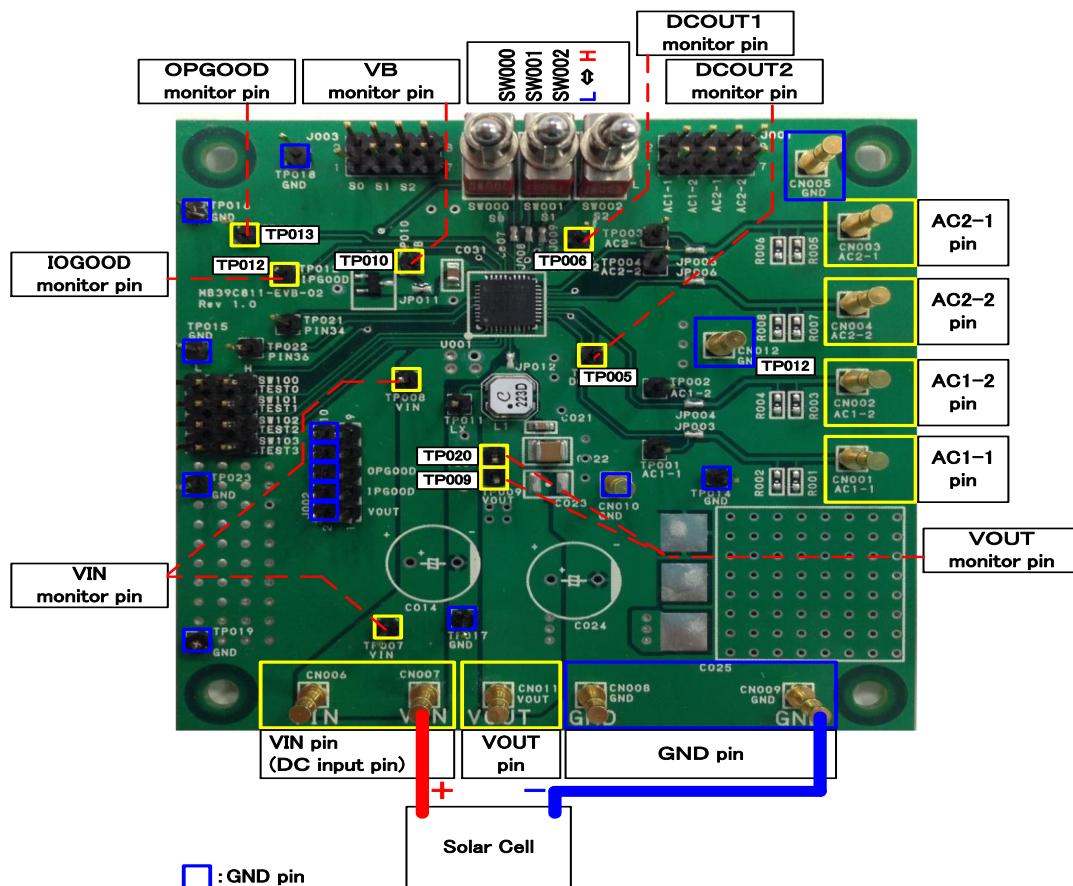
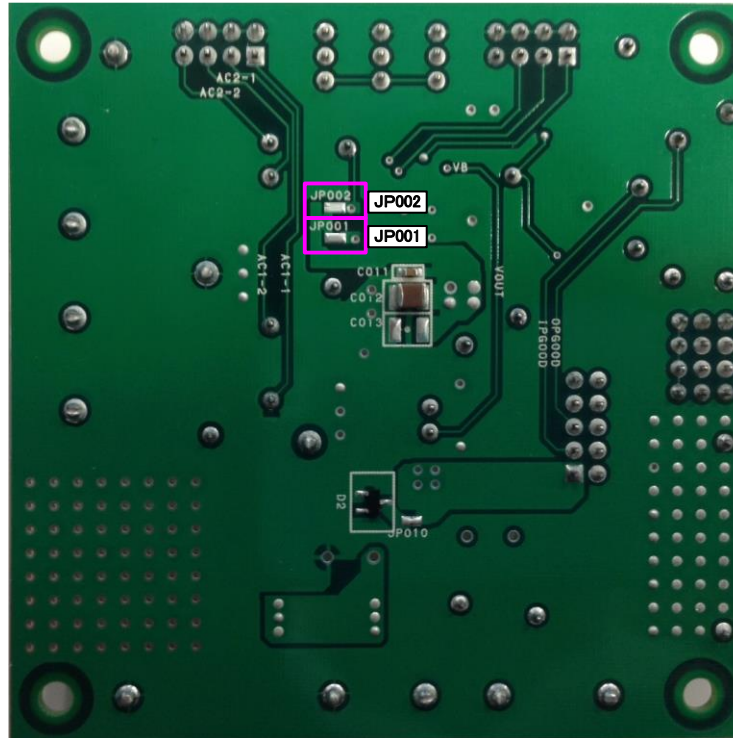

Figure 4-3. Jumper's connection between the bridge rectifier's output pins (DCOUT) and input pin (VIN)



 :When using the bridge rectifiers, Solder JP001、JP002 showed in this figure.

4.3 Vibration Energy Harvesting

1. Set the switches (SW000=L, SW001=L, SW002=L) as shown in the Figure 5-1 (see the Table 3-2 for the initial settings).
2. Connect the each jumper's land pattern (JP001 and JP002) by soldering as shown in the Figure 5-3.
3. Input AC voltages into CN001 and CN002 (AC1-1 and AC1-2) to make the VIN monitor pin 4V or more. The UVLO release voltage is required to start up (see the Table 1-1). Also, please consider the forward voltage drop because of the use of diodes (see the Table 1-1).
4. 1.5V is output to CN011 (VOUT).
5. To change the output voltage, change the switch settings (see the Table 3-3).

5. Component and Wiring Layout



5.1 Component Layout

Figure 5-1. Component layout (layer 1)

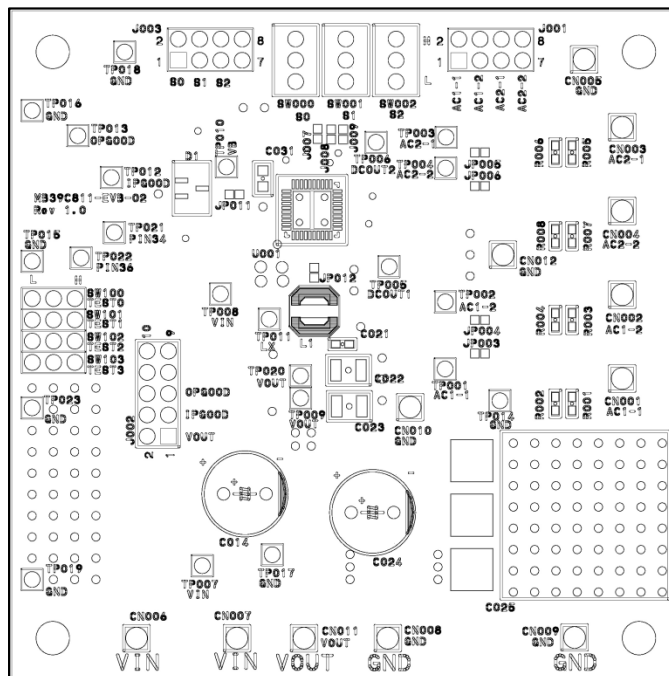
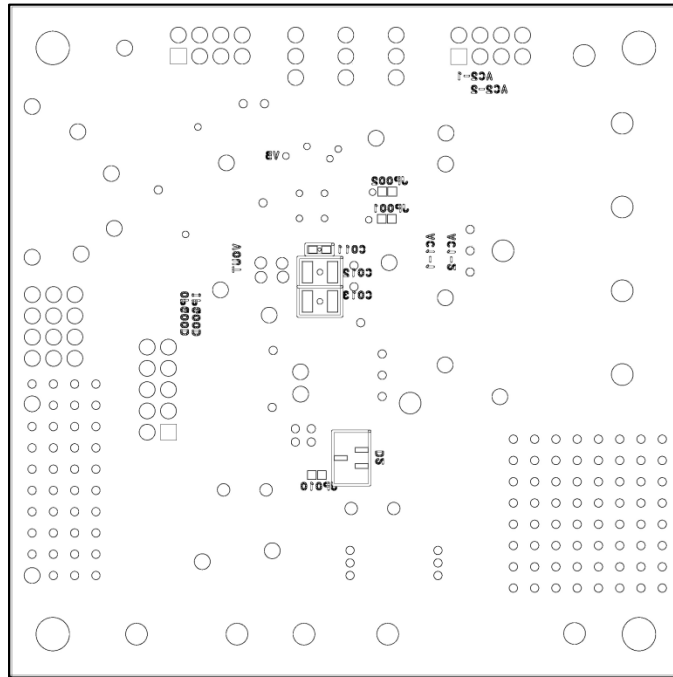

Figure 5-2. Component layout (layer 4)



5.2 Wiring Layout

Figure 5-3. Wiring layout (layer 1)

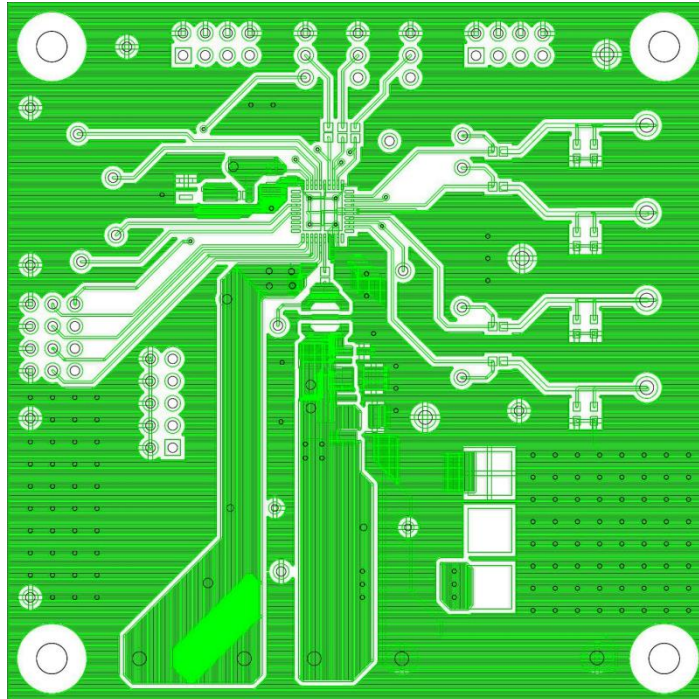

Figure 5-4. Wiring layout (layer 2)

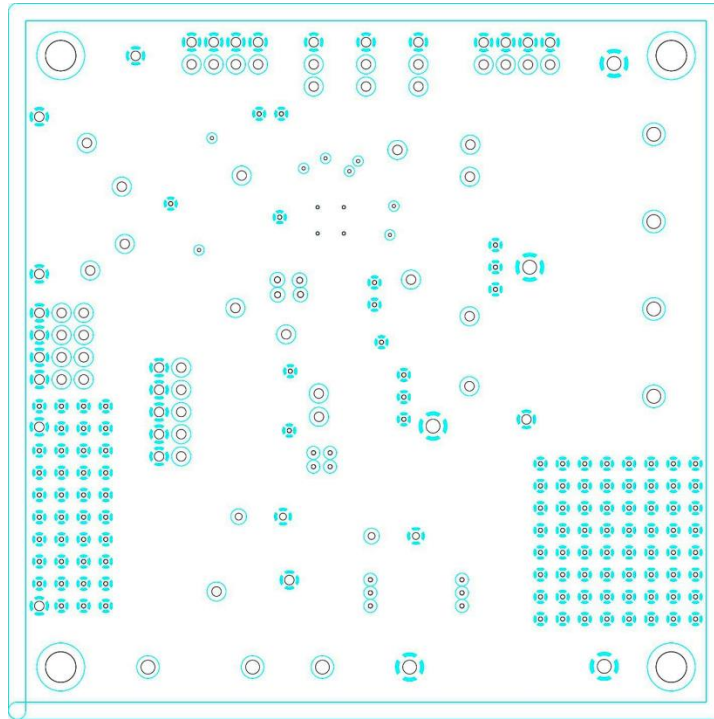

Figure 5-5. Wiring layout (layer 3)

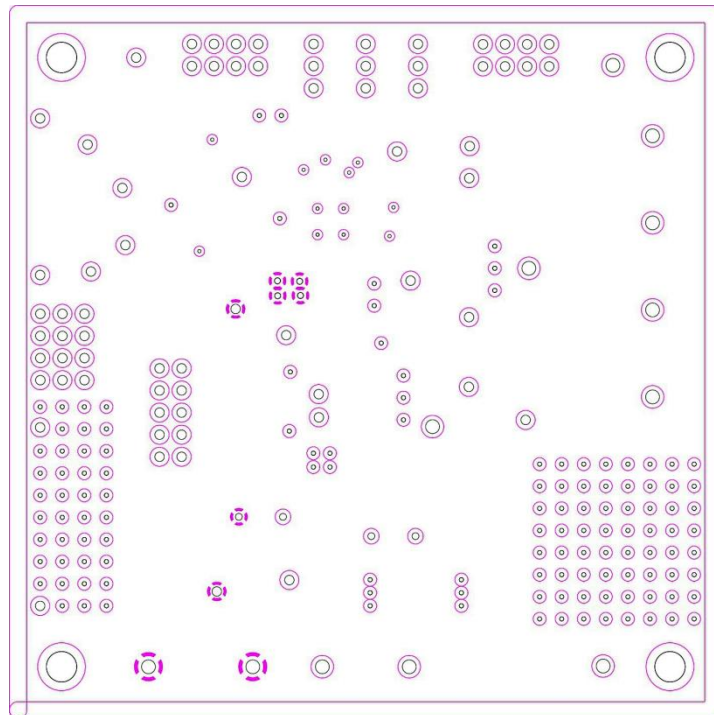
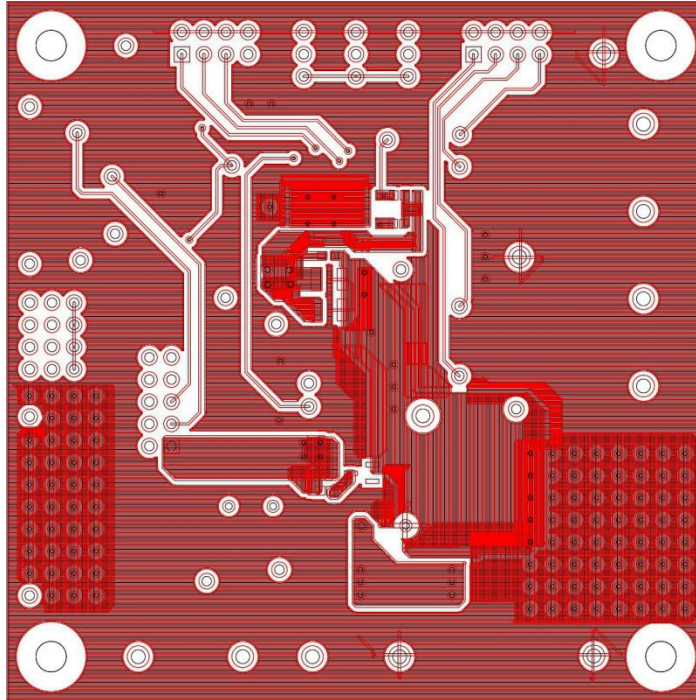

Figure 5-6. Wiring layout (layer 4)



6. Circuit Schematic



Figure 6-1. Circuit Schematic

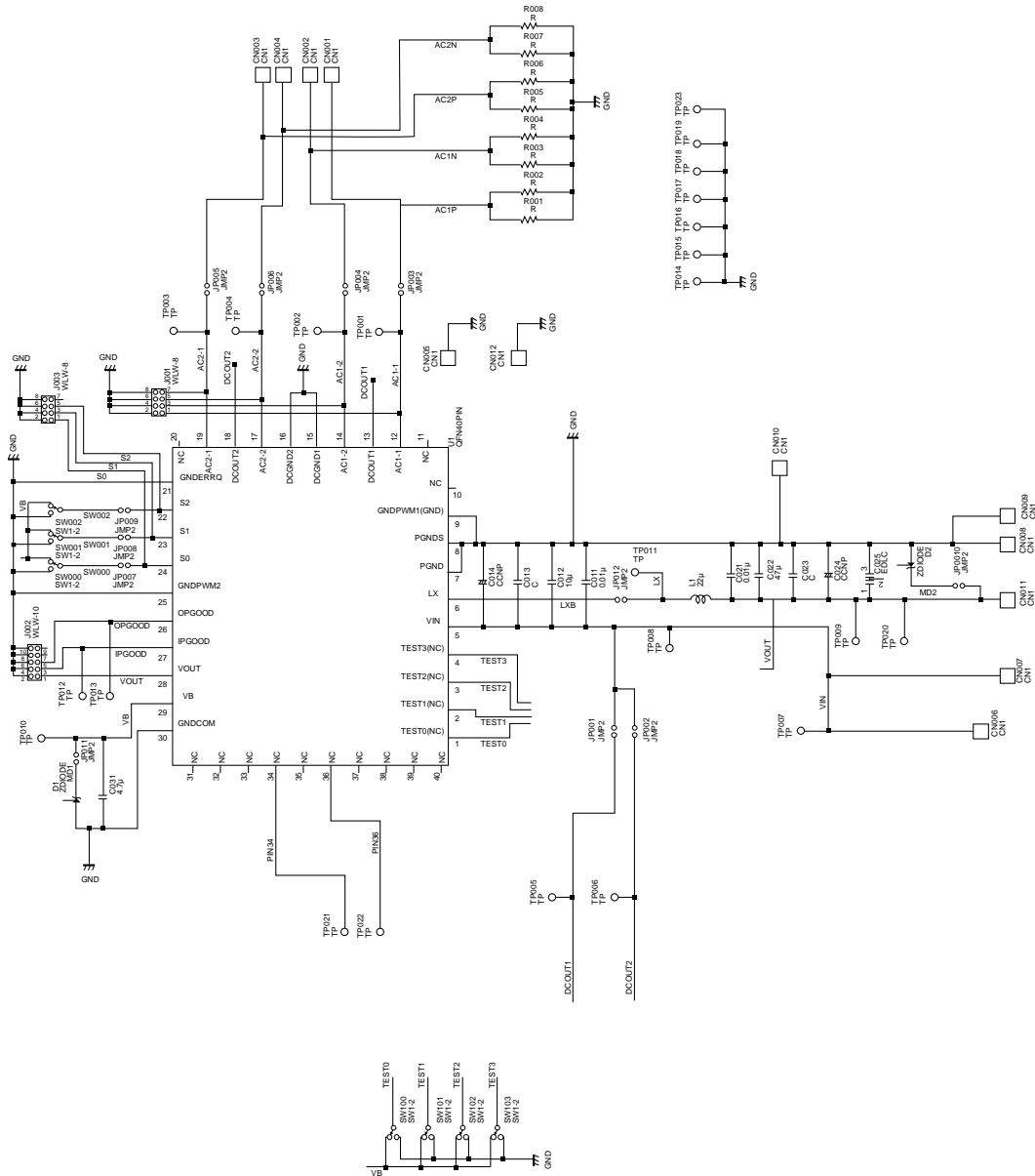

7. Component List



Table 7-1. Component list

No.	Component number	Non-mounted	Vender	Part number	Rating	Note
1	C011		murata	GRM188R71H103K A01D	50V	
2	C021		murata	GRM188R71H103K A01D	50V	
3	C012		murata	GRM32ER71H106K A12L	50V	
4	L1		COILCR AFT	LPS5030-223ML	-	4.9 x 4.9 mm footprint; less than 3 mm tall
5	C031		murata	GRM21BR71C475K A73L	16V	
6	C022		murata	GRM32ER71A476K E15L	10V	
7	C013	N.M.			-	Surface Mount Device (SMD): 3225
8	C023	N.M.			-	Surface Mount Device (SMD): 3225
9	C014	N.M.			-	Insertion Mount Device (IMD): 5.08mm
10	C024	N.M.			-	Insertion Mount Device (IMD): 5.08mm
11	CN001		mac8	WT-2-1	-	
12	CN002		mac8	WT-2-1	-	
13	CN003		mac8	WT-2-1	-	
14	CN004		mac8	WT-2-1	-	
15	CN005		mac8	WT-2-1	-	
16	CN006		mac8	WT-2-1	-	
17	CN007		mac8	WT-2-1	-	
18	CN008		mac8	WT-2-1	-	
19	CN009		mac8	WT-2-1	-	
20	CN010		mac8	WT-2-1	-	
21	CN011		mac8	WT-2-1	-	

No.	Component number	Non-mounted	Vender	Part number	Rating	Note
22	CN012		mac8	WT-2-1	-	
23	C025	N.M.	TDK	EDLC272020-501-2F	-	
24	JP001	N.M.			-	There are 1608 size lands on the EVB. They can be connected by soldering.
25	JP002	N.M.			-	There are 1608 size lands on the EVB. They can be connected by soldering.
26	JP003		-	-	-	The 1608 size lands on the EVB are connected by soldering.
27	JP004		-	-	-	The 1608 size lands on the EVB are connected by soldering.
28	JP005		-	-	-	The 1608 size lands on the EVB are connected by soldering.
29	JP006		-	-	-	The 1608 size lands on the EVB are connected by soldering.
30	JP007		-	-	-	The 1608 size lands on the EVB are connected by soldering.
31	JP008		-	-	-	The 1608 size lands on the EVB are connected by soldering.
32	JP009		-	-	-	The 1608 size lands on the EVB are connected by soldering.
33	JP010		-	-	-	The 1608 size lands on the EVB are connected by soldering.
34	JP011		-	-	-	The 1608 size lands on the EVB are connected by soldering.
35	JP012		-	-	-	The 1608 size lands on the EVB are connected by soldering.
36	U1		Cypress	MB39C811(CS)	-	
37	R001	N.M.	KOA	RK73B1JTTD101J	1/10W	
38	R002	N.M.	KOA	RK73B1JTTD101J	1/10W	
39	R003	N.M.	KOA	RK73B1JTTD101J	1/10W	
40	R004	N.M.	KOA	RK73B1JTTD101J	1/10W	
41	R005	N.M.	KOA	RK73B1JTTD101J	1/10W	
42	R006	N.M.	KOA	RK73B1JTTD101J	1/10W	
43	R007	N.M.	KOA	RK73B1JTTD101J	1/10W	
44	R008	N.M.	KOA	RK73B1JTTD101J	1/10W	
45	SW000		CoslandCo.,Ltd.	2MS1-T1-B4-M2-Q-E	-	
46	SW001		CoslandCo.,Ltd.	2MS1-T1-B4-M2-Q-E	-	
47	SW002		CoslandCo.,Ltd.	2MS1-T1-B4-M2-Q-E	-	
48	SW100	N.M.	Linkman	2130S1*40GSE	1A	
49	SW101	N.M.	Linkman	2130S1*40GSE	1A	
50	SW102	N.M.	Linkman	2130S1*40GSE	1A	
51	SW103	N.M.	Linkman	2130S1*40GSE	1A	

No.	Component number	Non-mounted	Vender	Part number	Rating	Note
52	TP001		Linkman	2130S1*40GSE	1A	
53	TP002		Linkman	2130S1*40GSE	1A	
54	TP003		Linkman	2130S1*40GSE	1A	
55	TP004		Linkman	2130S1*40GSE	1A	
56	TP005		Linkman	2130S1*40GSE	1A	
57	TP006		Linkman	2130S1*40GSE	1A	3 × 1 pin header
58	TP007		Linkman	2130S1*40GSE	1A	3 × 1 pin header
59	TP008		Linkman	2130S1*40GSE	1A	3 × 1 pin header
60	TP009		Linkman	2130S1*40GSE	1A	3 × 1 pin header
61	TP010		Linkman	2130S1*40GSE	1A	1 pin header
62	TP011		Linkman	2130S1*40GSE	1A	1 pin header
63	TP012		Linkman	2130S1*40GSE	1A	1 pin header
64	TP013		Linkman	2130S1*40GSE	1A	1 pin header
65	TP014		Linkman	2130S1*40GSE	1A	1 pin header
66	TP015		Linkman	2130S1*40GSE	1A	1 pin header
67	TP016		Linkman	2130S1*40GSE	1A	1 pin header
68	TP017		Linkman	2130S1*40GSE	1A	1 pin header
69	TP018		Linkman	2130S1*40GSE	1A	1 pin header
70	TP019		Linkman	2130S1*40GSE	1A	1 pin header
71	TP020		Linkman	2130S1*40GSE	1A	1 pin header
72	TP021		Linkman	2130S1*40GSE	1A	1 pin header
73	TP022		Linkman	2130S1*40GSE	1A	1 pin header
74	TP023		Linkman	2130S1*40GSE	1A	1 pin header
75	J001		Linkman	2130S1*40GSE	1A	1 pin header
76	J002		Linkman	2130S1*40GSE	1A	1 pin header
77	J003		Linkman	2130S1*40GSE	1A	1 pin header
78	D1		NXP Semicon.	PLVA662A	-	1 pin header
79	D2		NXP Semicon.	PLVA662A	-	1 pin header

These components are compliant with RoHS, but please ask each vender for details if necessary.

8. Evaluation Board Picture



Figure 8-1. Picture (top)

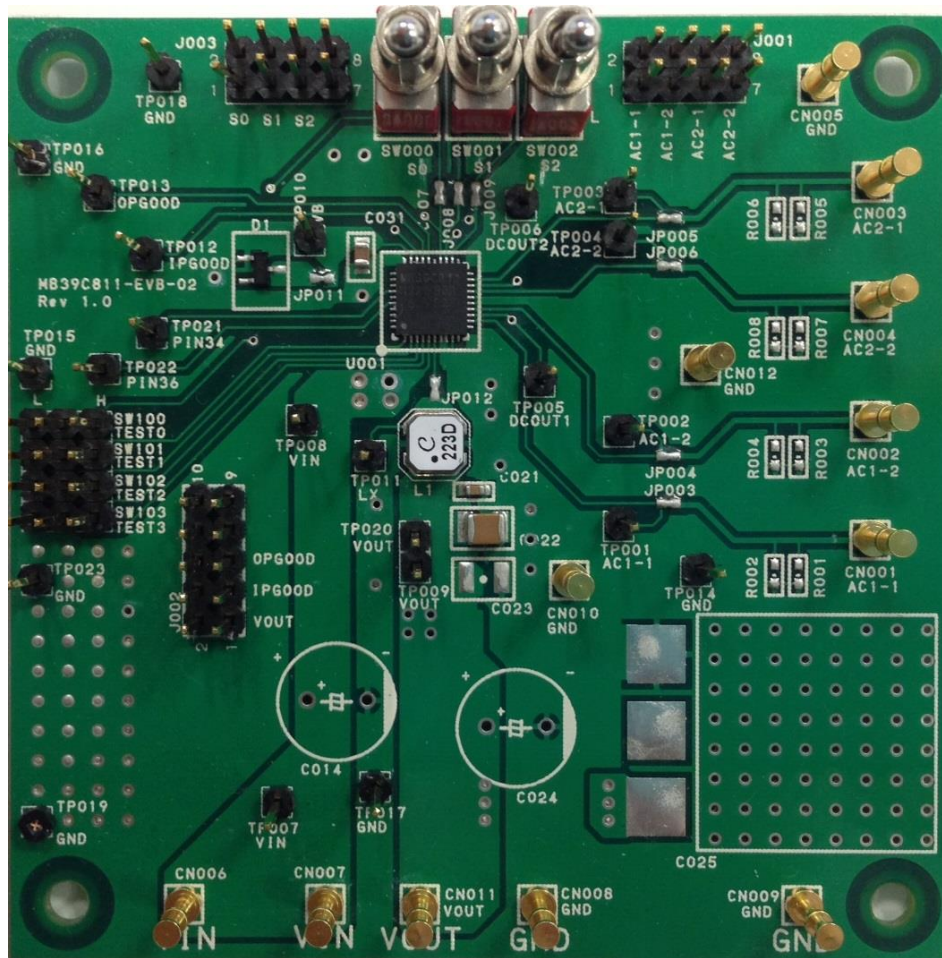
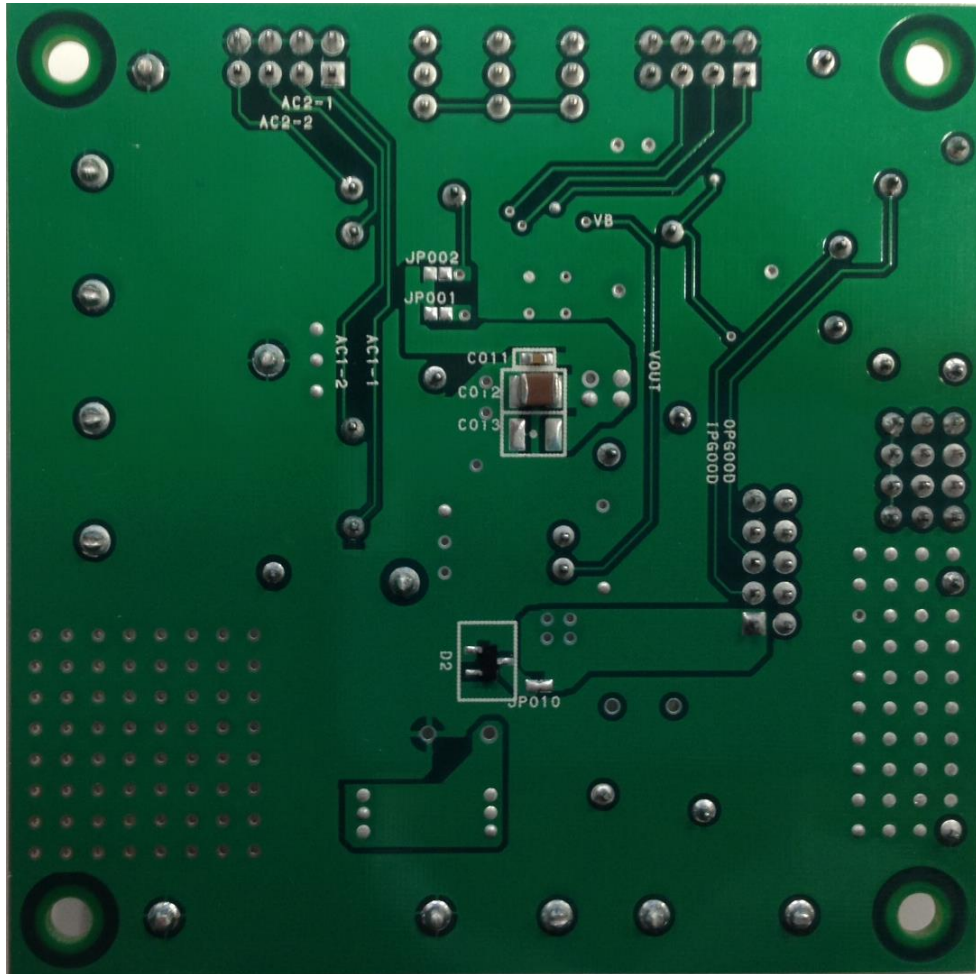

Figure 8-2. Picture (back)



9. Ordering Information



Table 9-1. Ordering Information

Part number	EVB revision	Note
MB39C811-EVB-02	Rev 1.0	---

Revision History



Document Revision History

Document Title: Energy Harvesting with MB39C811-EVB-02 Evaluation Board Operation Guide			
Document Number: 002-08633			
Revision	Issue Date	Origin of Change	Description of Change
**	01/27/2014	EIFU	Initial release
*A	01/29/2016	EIFU	Migrated Spansion Guide from MB39C811-EVB-02_SS901-00017-1v0-E to Cypress format
*B	10/23/2017	MASG	Adapted Cypress new logo.