

Sensor/actuator cable - SAC-HZ-5P-MS/1,5-542/FRSHSCOBK - 1409580

Please be informed that the data shown in this PDF Document is generated from our Online Catalog. Please find the complete data in the user's documentation. Our General Terms of Use for Downloads are valid (<http://phoenixcontact.com/download>)

Sensor/actuator cable, 5-position, PVC, yellow, shielded, Plug straight M12 SPEEDCON, A-coded, on Socket angled M12 SPEEDCON, A-coded, cable length: 1.5 m



Key Commercial Data

Packing unit	1 pc
Minimum order quantity	10 pc
GTIN	 4 055626 018362
GTIN	4055626018362

Technical data

Dimensions

Length of cable	1.5 m
-----------------	-------

Ambient conditions

Ambient temperature (operation)	-25 °C ... 90 °C (Plug / socket)
Degree of protection	IP65/IP67

General

Note	These cable assemblies are UL/cUL listed for use in Class I, Division 2 (CID2) hazardous locations.
Rated current at 40°C	4 A
Rated voltage	48 V AC 60 V DC
Number of positions	5
Insulation resistance	≥ 100 MΩ
Coding	A - standard
Standards/regulations	M12 connector IEC 61076-2-101
Status display	No
Protective circuit/component	unwired

Sensor/actuator cable - SAC-HZ-5P-MS/1,5-542/FRSHSCOBK - 1409580

Technical data

General

Overvoltage category	II
Degree of pollution	3
Torque	0.4 Nm (M12 connector)

Material

Flammability rating according to UL 94	HB
Contact material	CuSn
Contact surface material	Ni/Au
Contact carrier material	TPU GF
Material of grip body	TPU, hardly inflammable, self-extinguishing
Material, knurls	Zinc die-cast, nickel-plated
Sealing material	NBR

Standards and Regulations

Standard designation	M12 connector
Standards/regulations	IEC 61076-2-101
Flammability rating according to UL 94	HB
UL, USA/Canada	Class I, Div. 2, Groups A, B, C, D

Cable

Cable type	PVC yellow 105 °C
Cable type (abbreviation)	542
UL AWM style	2517 (105 °C / 300 V)
AWG signal line	22
Conductor structure signal line	30x 1.30 mm
Core diameter including insulation	1.27 mm ±0.03 mm
Wire colors	Brown, blue, black, white, gray
Overall twist	5 wires around filler to the core
Shielding	Tinned copper braided shield
Optical shield covering	85 %
External sheath, color	yellow
External cable diameter D	5.9 mm ±0.2 mm
Minimum bending radius, flexible installation	12 x D
Cable weight	57 kg/km
Outer sheath, material	PVC
Material, filler	PP
Material conductor insulation	PVC
Conductor material	Tin-plated Cu litz wires
Insulation resistance	≥ (550 M Ohms/m @ 500V)
Conductor resistance	max. 50.5 Ω/km (20 °C)
Nominal voltage, cable	300 V
Special properties	UL standards PLTC and ITC

Sensor/actuator cable - SAC-HZ-5P-MS/1,5-542/FRSHSCOBK - 1409580

Technical data

Cable

Flame resistance	FT4
Other resistance	UV resistant
Ambient temperature (operation)	-30 °C ... 105 °C (cable, fixed installation)
	-5 °C ... 105 °C (cable, flexible installation)

Environmental Product Compliance

China RoHS	Environmentally friendly use period: unlimited = EFUP-e
	No hazardous substances above threshold values

Drawings

Sensor/actuator cable - SAC-HZ-5P-MS/1,5-542/FRSHSCOBK - 1409580

Dimensional drawing

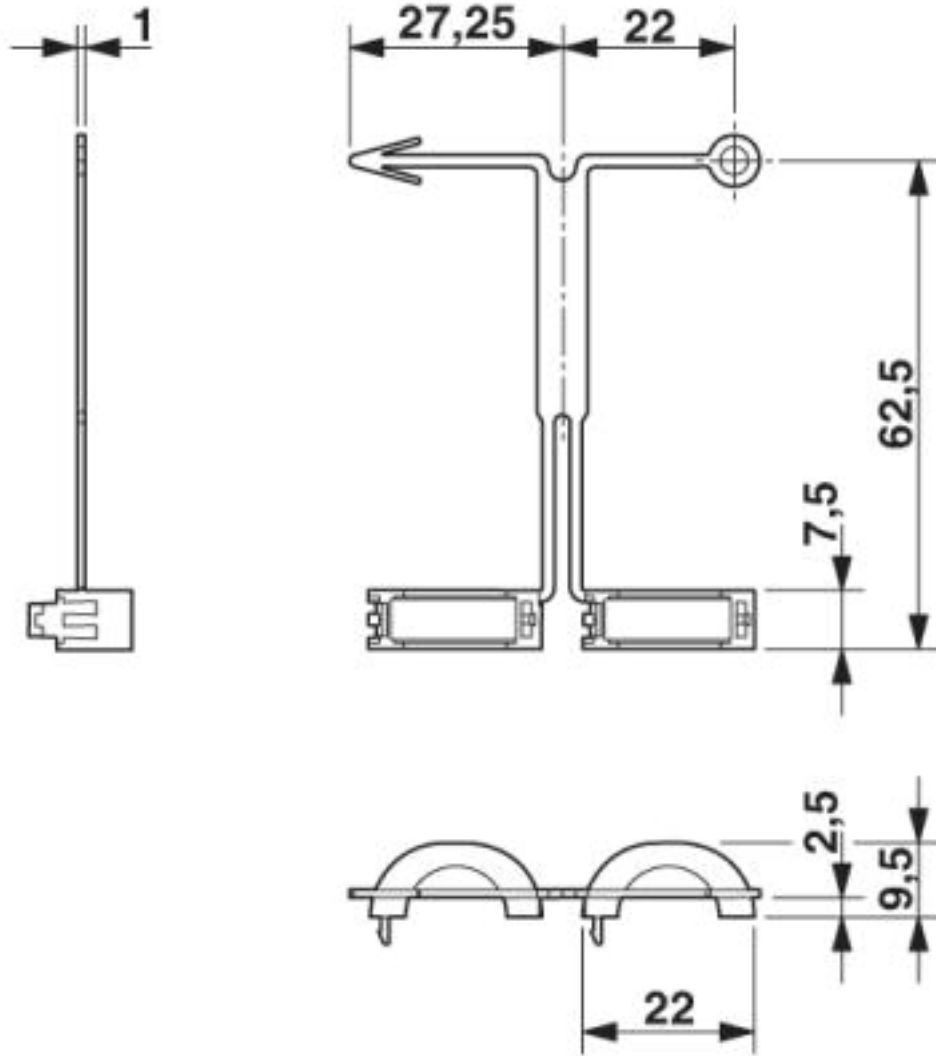

EXCLIP plug

Sensor/actuator cable - SAC-HZ-5P-MS/1,5-542/FRSHSCOBK - 1409580

Dimensional drawing

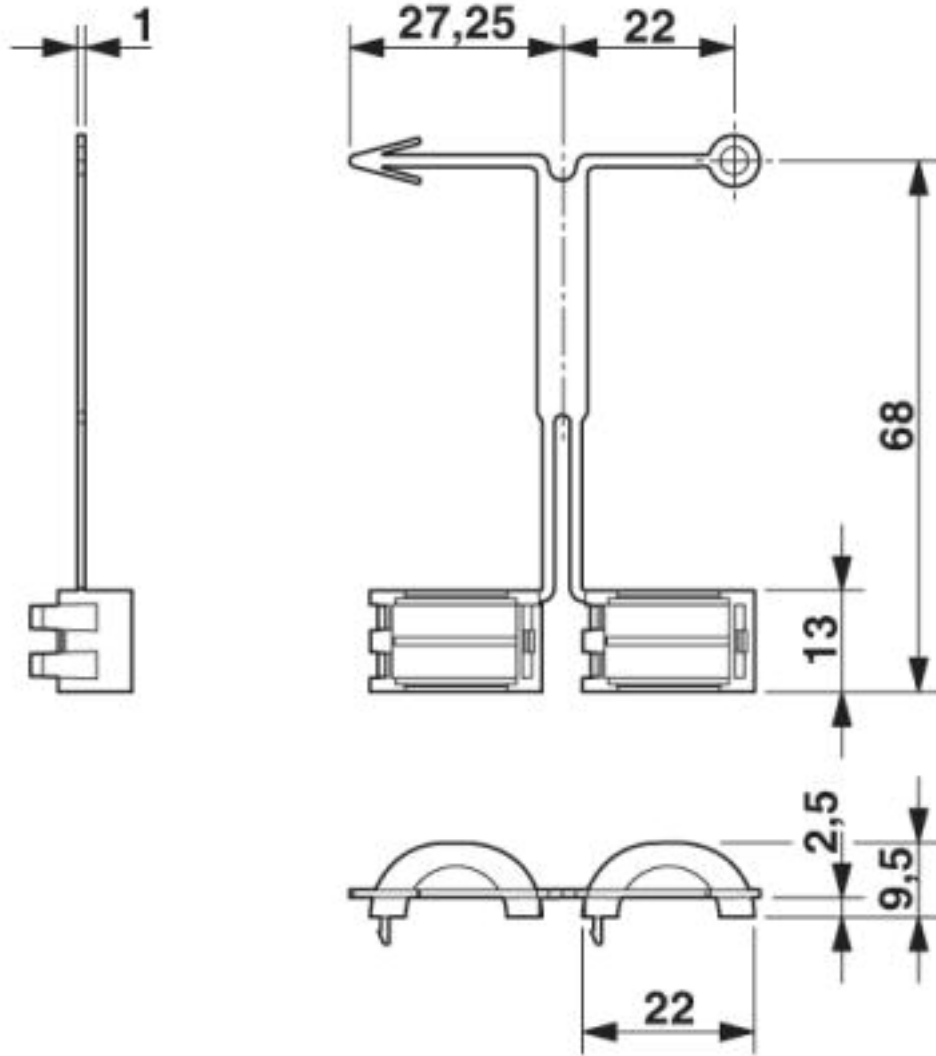

EXCLIP socket

Sensor/actuator cable - SAC-HZ-5P-MS/1,5-542/FRSHSCOBK - 1409580

Dimensional drawing

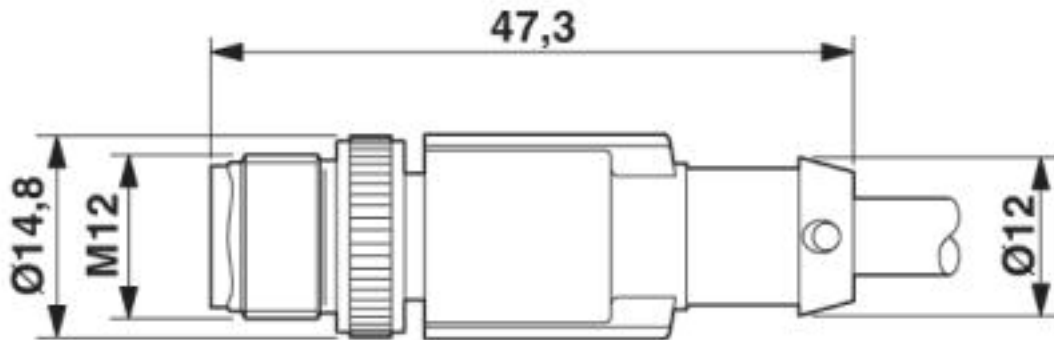

Plug, M12 x 1, straight, shielded

Dimensional drawing

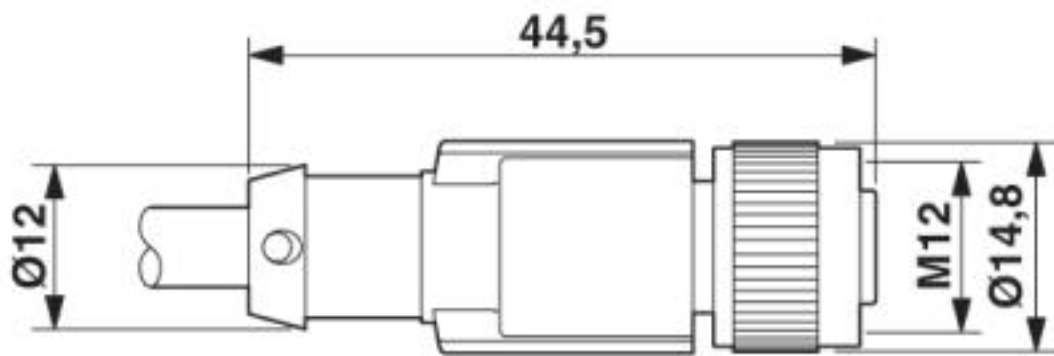

M12 x 1 socket, straight, shielded

Dimensional drawing

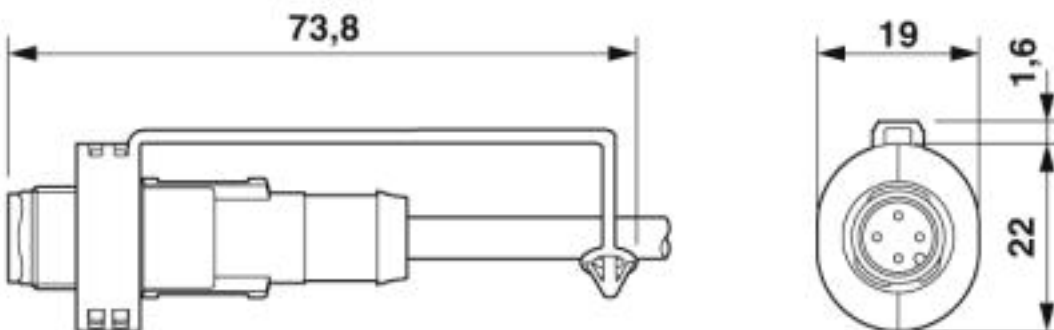

EXCLIP mounted plug

Sensor/actuator cable - SAC-HZ-5P-MS/1,5-542/FRSHSCOBK - 1409580

Dimensional drawing

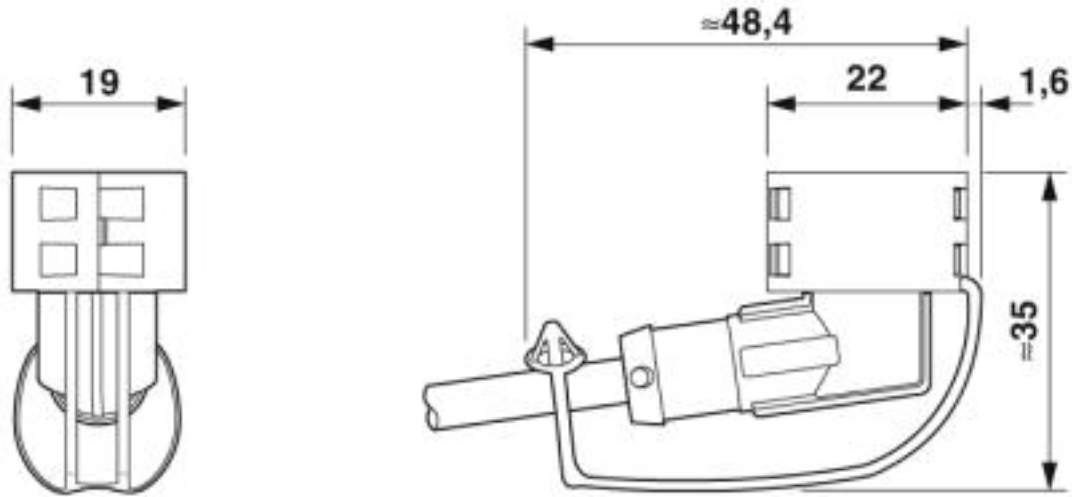

EXCLIP mounted plug

Circuit diagram

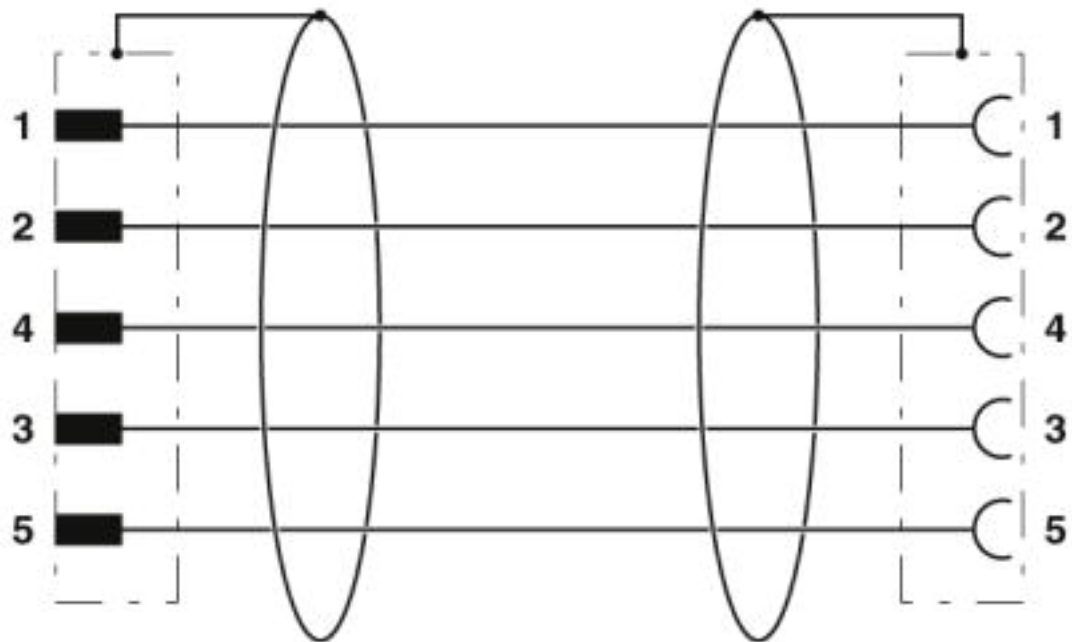

Contact assignment of the M12 plug and the M12 socket

Sensor/actuator cable - SAC-HZ-5P-MS/1,5-542/FRSHSCOBK - 1409580

Schematic diagram

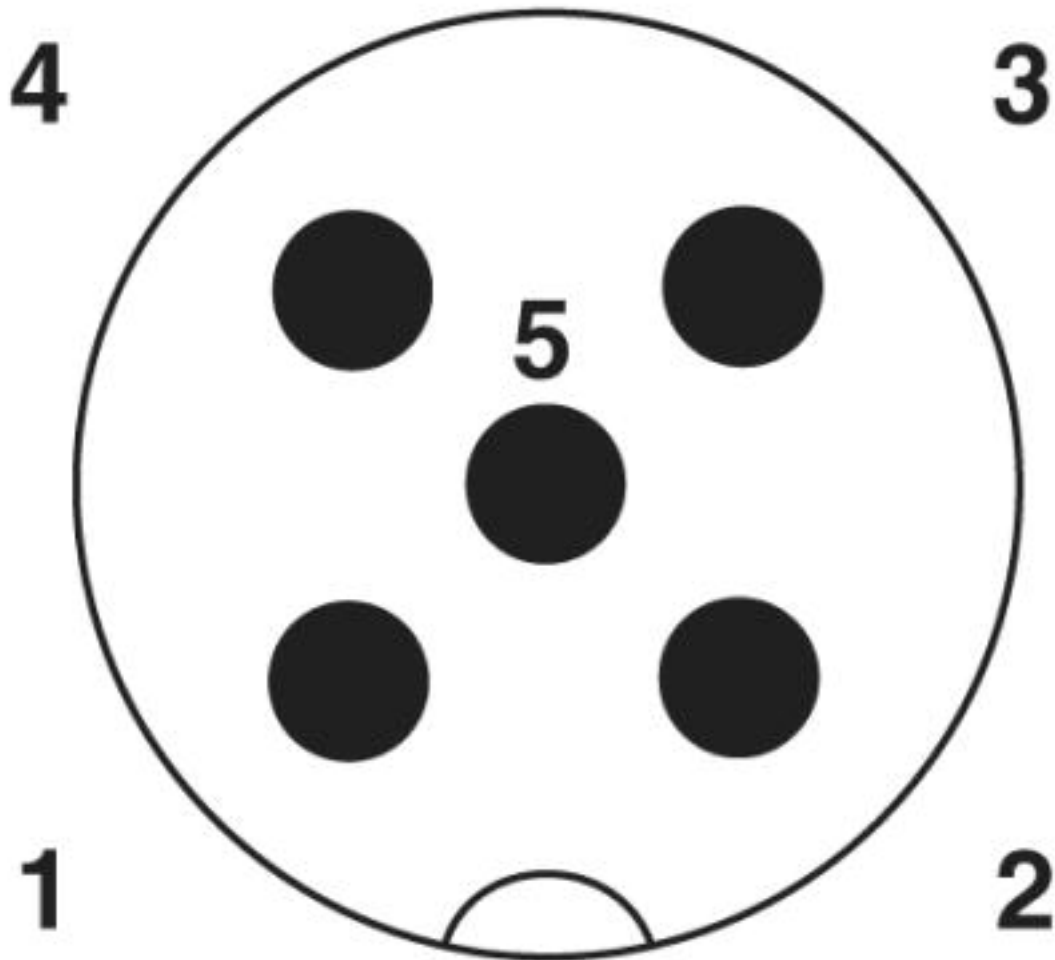

Pin assignment M12 male connector, 5-pos., A-coded, male side

Sensor/actuator cable - SAC-HZ-5P-MS/1,5-542/FRSHSCOBK - 1409580

Schematic diagram

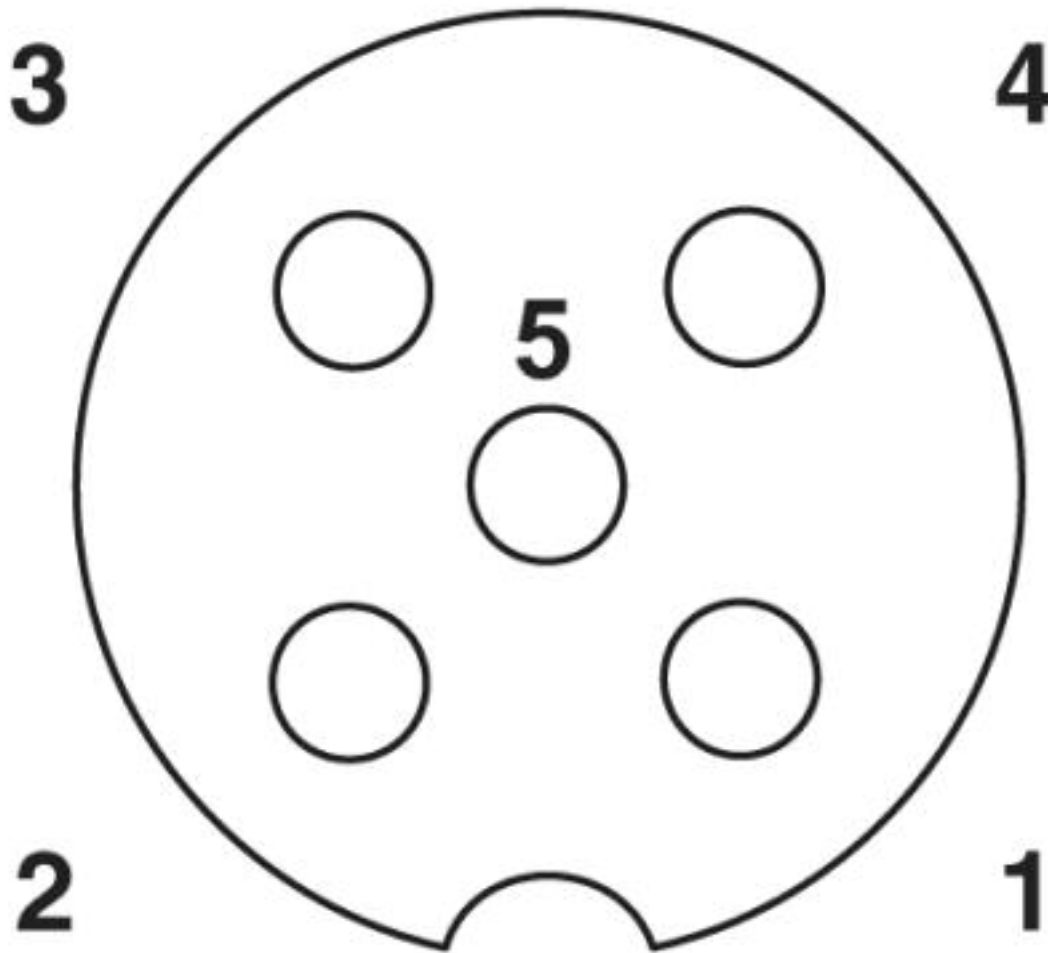

Pin assignment M12 socket, 5-pos., A-coded, socket side view

Sensor/actuator cable - SAC-HZ-5P-MS/1,5-542/FRSHSCOBK - 1409580

Cable cross section

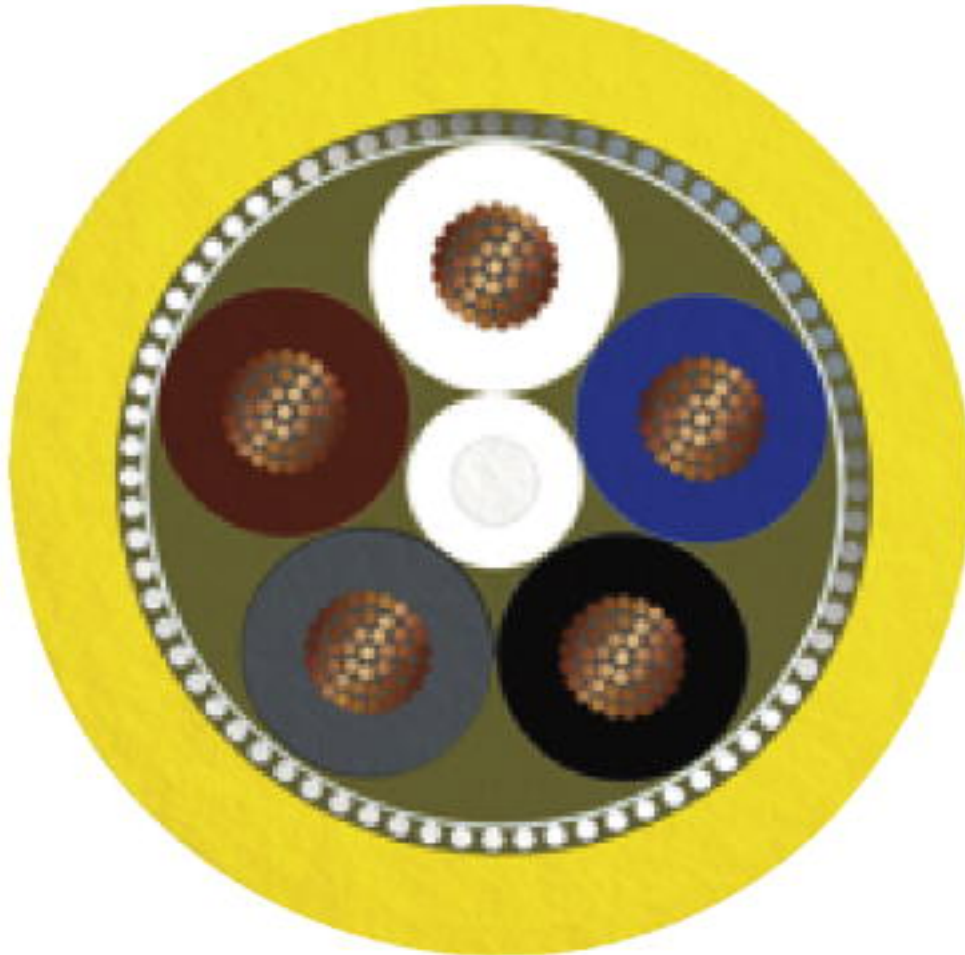

PVC yellow 105 °C [542]

Phoenix Contact 2019 © - all rights reserved
<http://www.phoenixcontact.com>

PHOENIX CONTACT GmbH & Co. KG
Flachsmarktstr. 8
32825 Blomberg
Germany
Tel. +49 5235 300
Fax +49 5235 3 41200
<http://www.phoenixcontact.com>