

# LB E67C

## Power TOPLED®

PowerTOPLED, a powerful member of the TOPLED family. Thanks to their high luminous efficacy, the LEDs are ideal for rear light clusters and indicators on vehicles and for display panels for traffic control systems.



## Applications

- Cluster, Button Backlighting
- Electronic Equipment
- Interior Illumination (e.g. Ambient Map)

## Features:

- Package: white PLCC-4 package, colorless clear resin
- Chip technology: InGaN
- Typ. Radiation: 120° (Lambertian emitter)
- Color:  $\lambda_{\text{dom}} = 470 \text{ nm}$  (● blue)
- Corrosion Robustness Class: 3B
- ESD: 2 kV acc. to ANSI/ESDA/JEDEC JS-001 (HBM, Class 2)

---

## Ordering Information

| Type              | Luminous Intensity <sup>1)</sup><br>$I_F = 30 \text{ mA}$<br>$I_v$ | Ordering Code |
|-------------------|--|---------------|
| LB E67C-Q1S2-35-1 | 71 ... 280 mcd   | Q65110A9140   |

---

## Maximum Ratings

| Parameter  | Symbol    |      | Values |
|--|-----------|------|--------|
| Operating Temperature  | $T_{op}$  | min. | -40 °C |
|  |           | max. | 100 °C |
| Storage Temperature  | $T_{stg}$ | min. | -40 °C |
|  |           | max. | 100 °C |
| Junction Temperature   | $T_j$     | max. | 110 °C |
| Forward current<br>$T_s = 25\text{ °C}$  | $I_F$     | max. | 30 mA  |
| Surge Current<br>$t \leq 10\text{ }\mu\text{s}$ ; $D = 0.005$ ; $T_s = 25\text{ °C}$ | $I_{FS}$  | max. | 300 mA |
| Reverse voltage <sup>2)</sup><br>$T_s = 25\text{ °C}$                                | $V_R$     | max. | 5 V    |
| ESD withstand voltage<br>acc. to ANSI/ESDA/JEDEC JS-001 (HBM, Class 2)               | $V_{ESD}$ |      | 2 kV   |

## Characteristics

$I_F = 30 \text{ mA}$ ;  $T_S = 25 \text{ °C}$

| Parameter   | Symbol                              |                      | Values                                 |
|---|-------------------------------------|----------------------|--|
| Peak Wavelength   | $\lambda_{\text{peak}}$             | typ.                 | 465 nm                                 |
| Dominant Wavelength <sup>3)</sup><br>$I_F = 30 \text{ mA}$                            | $\lambda_{\text{dom}}$              | min.<br>typ.<br>max. | 463 nm<br>470 nm<br>475 nm             |
| Spectral Bandwidth at 50% $I_{\text{rel,max}}$  | $\Delta\lambda$                     | typ.                 | 25 nm                                  |
| Viewing angle at 50% $I_V$  | $2\phi$                             | typ.                 | 120 °                                  |
| Forward Voltage <sup>4)</sup><br>$I_F = 30 \text{ mA}$                                | $V_F$                               | min.<br>typ.<br>max. | 2.90 V<br>3.40 V<br>4.40 V             |
| Reverse current <sup>2)</sup><br>$V_R = 5 \text{ V}$                                  | $I_R$                               | typ.<br>max.         | 0.01 $\mu\text{A}$<br>10 $\mu\text{A}$ |
| Temperature Coefficient of Peak Wavelength<br>$-10\text{°C} \leq T \leq 100\text{°C}$ | $\text{TC}_{\lambda_{\text{peak}}}$ | typ.                 | 0.04 nm / K                            |
| Real thermal resistance junction/ambient <sup>5)6)</sup>                              | $R_{\text{thJA real}}$              | max.                 | 350 K / W                              |
| Real thermal resistance junction/solderpoint <sup>5)</sup>                            | $R_{\text{thJS real}}$              | max.                 | 180 K / W                              |

## Brightness Groups

| Group | Luminous Intensity <sup>1)</sup><br>$I_F = 30 \text{ mA}$<br>min.<br>$I_v$ | Luminous Intensity <sup>1)</sup><br>$I_F = 30 \text{ mA}$<br>max.<br>$I_v$ | Luminous Flux <sup>7)</sup><br>$I_F = 30 \text{ mA}$<br>typ.<br>$\Phi_v$ |
|-------|--|--|--|
| Q1    | 71 mcd   | 90 mcd   | 290 mlm  |
| Q2    | 90 mcd   | 112 mcd  | 360 mlm  |
| R1    | 112 mcd  | 140 mcd  | 450 mlm  |
| R2    | 140 mcd  | 180 mcd  | 580 mlm  |
| S1    | 180 mcd  | 224 mcd  | 730 mlm  |
| S2    | 224 mcd  | 280 mcd  | 910 mlm  |

## Forward Voltage Groups

| Group | Forward Voltage <sup>4)</sup><br>$I_F = 30 \text{ mA}$<br>min.<br>$V_F$ | Forward Voltage <sup>4)</sup><br>$I_F = 30 \text{ mA}$<br>max.<br>$V_F$ |
|-------|---|---|
| 2     | 2.90 V  | 3.30 V  |
| 3     | 3.30 V  | 3.80 V  |
| 4     | 3.80 V  | 4.40 V  |

## Wavelength Groups

| Group | Dominant Wavelength <sup>3)</sup><br>$I_F = 30 \text{ mA}$<br>min.<br>$\lambda_{\text{dom}}$ | Dominant Wavelength <sup>3)</sup><br>$I_F = 30 \text{ mA}$<br>max.<br>$\lambda_{\text{dom}}$ |
|-------|--|--|
| 3     | 463 nm   | 467 nm   |
| 4     | 467 nm   | 471 nm   |
| 5     | 471 nm   | 475 nm   |

---

## Group Name on Label

**Example: Q1-3-2**

Brightness

Wavelength

Forward Voltage

---

Q1

3

2

---

### Relative Spectral Emission <sup>7)</sup>

$I_{rel} = f(\lambda); I_F = 30 \text{ mA}; T_S = 25 \text{ }^\circ\text{C}$

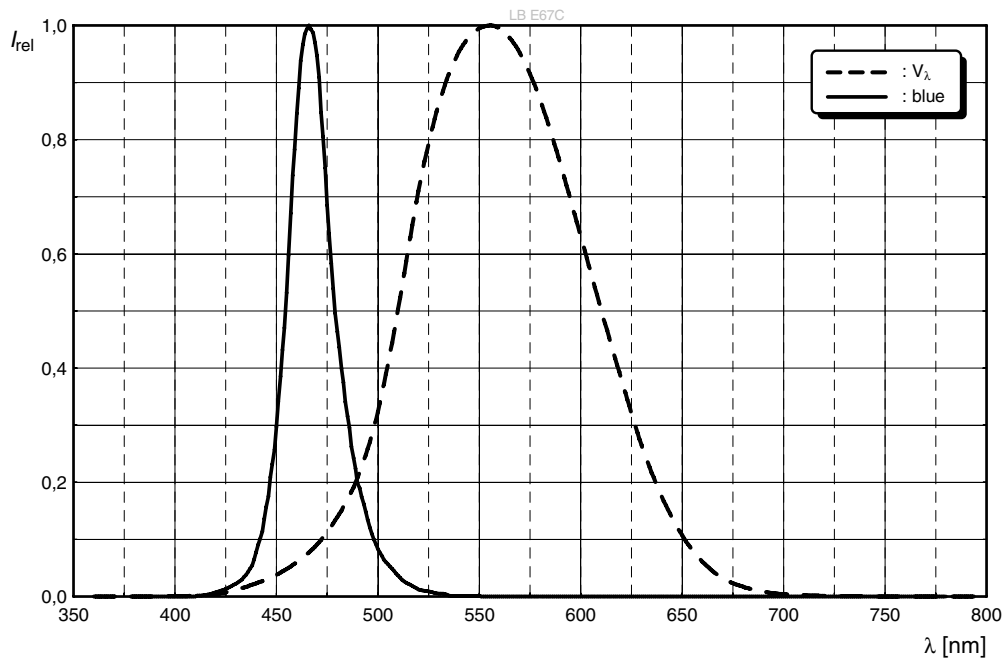

### Radiation Characteristics <sup>7)</sup>

$I_{rel} = f(\phi); T_S = 25 \text{ }^\circ\text{C}$

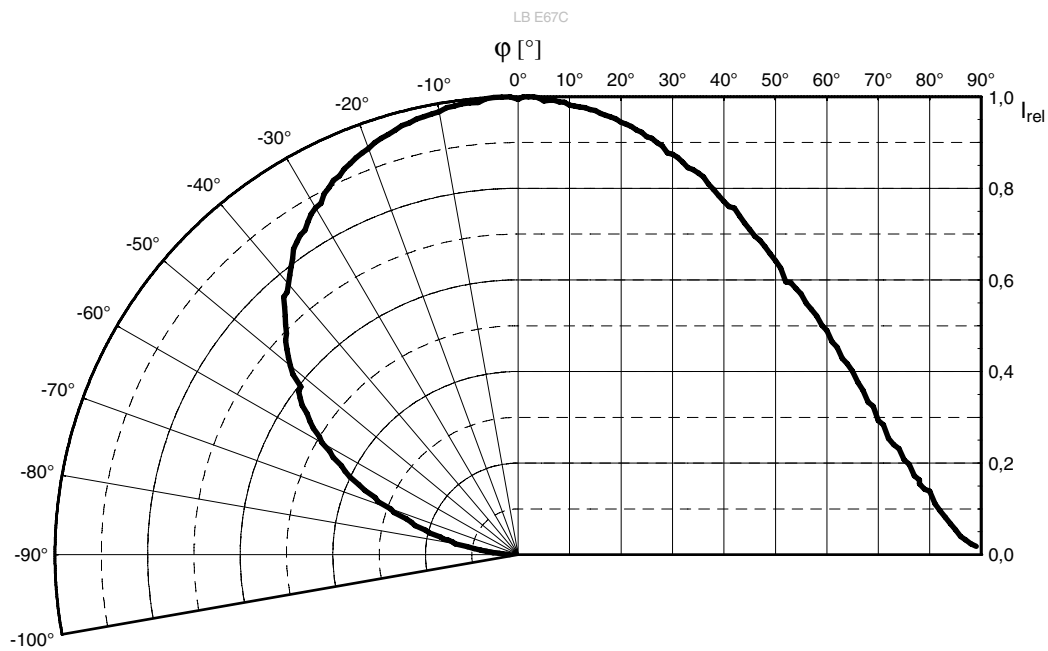

Discontinued

**Forward current** 7), 8)

$I_F = f(V_F); T_S = 25\text{ °C}$

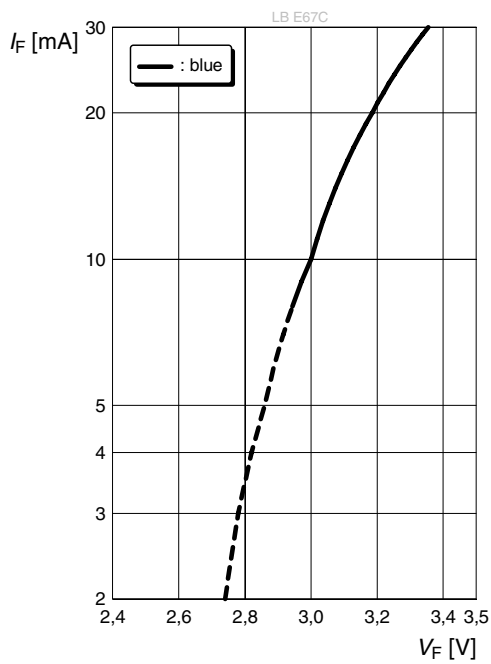

**Relative Luminous Intensity** 7), 8)

$I_V/I_V(30\text{ mA}) = f(I_F); T_S = 25\text{ °C}$

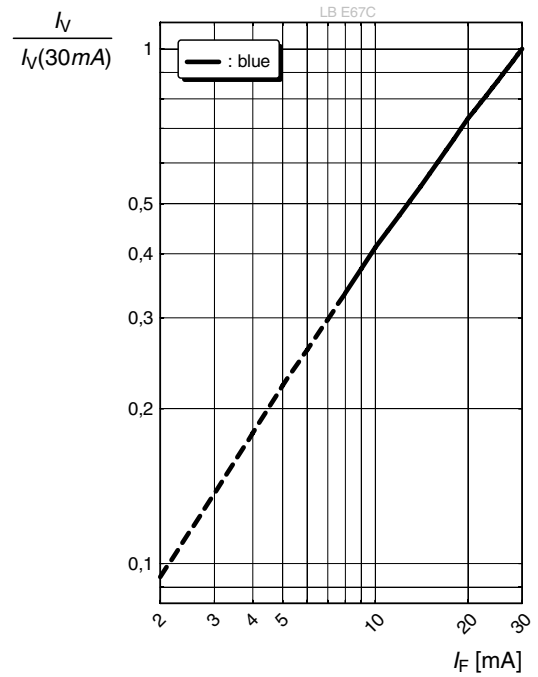

**Dominant Wavelength** 7)

$\Delta\lambda_{\text{dom}} = f(I_F); T_S = 25\text{ °C}$

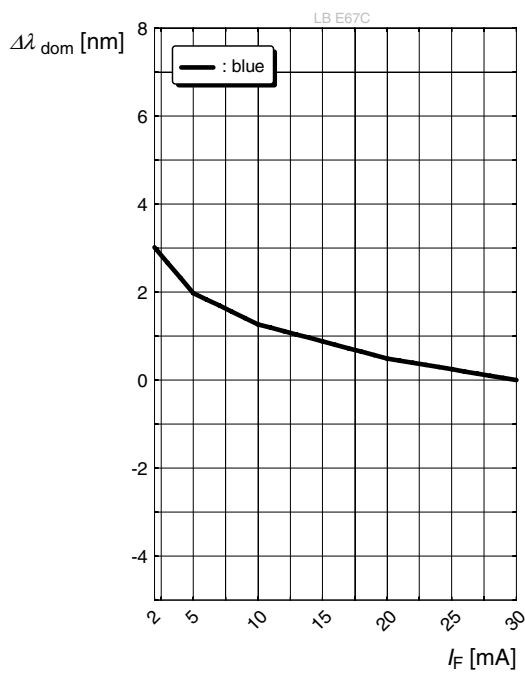

Discontinued



### Forward Voltage <sup>7)</sup>

$$\Delta V_F = V_F - V_F(25^\circ\text{C}) = f(T_j); I_F = 30\text{ mA}$$

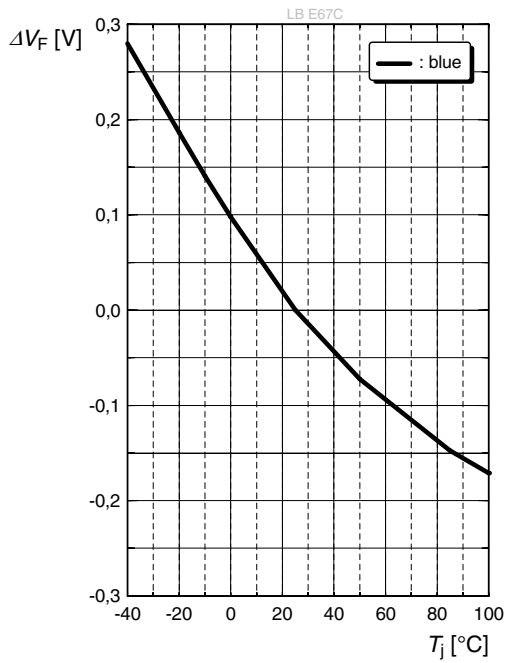

### Relative Luminous Intensity <sup>7)</sup>

$$I_V/I_V(25^\circ\text{C}) = f(T_j); I_F = 30\text{ mA}$$

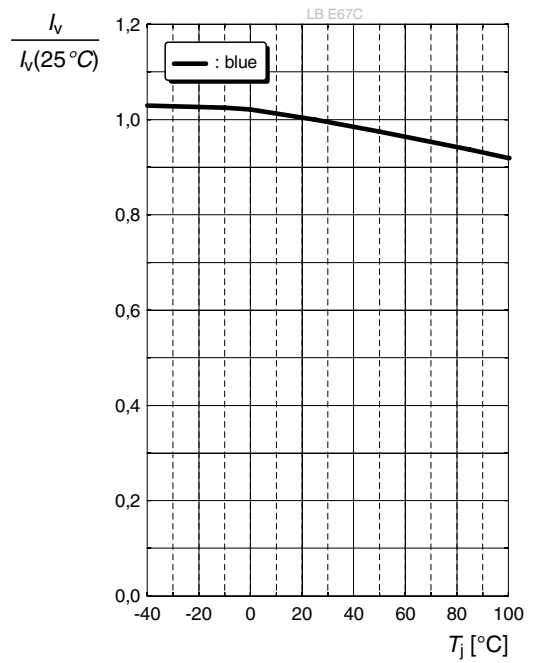

### Dominant Wavelength <sup>7)</sup>

$$\Delta \lambda_{\text{dom}} = \lambda_{\text{dom}} - \lambda_{\text{dom}}(25^\circ\text{C}) = f(T_j); I_F = 30\text{ mA}$$

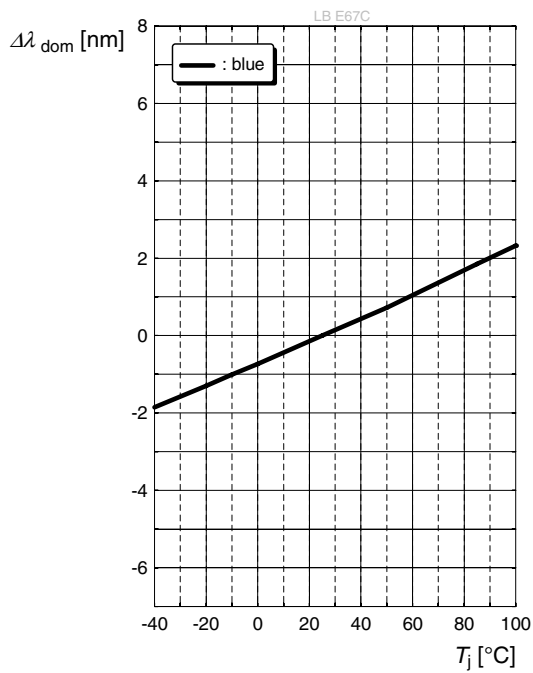

Discontinued

### Max. Permissible Forward Current

$I_F = f(T)$

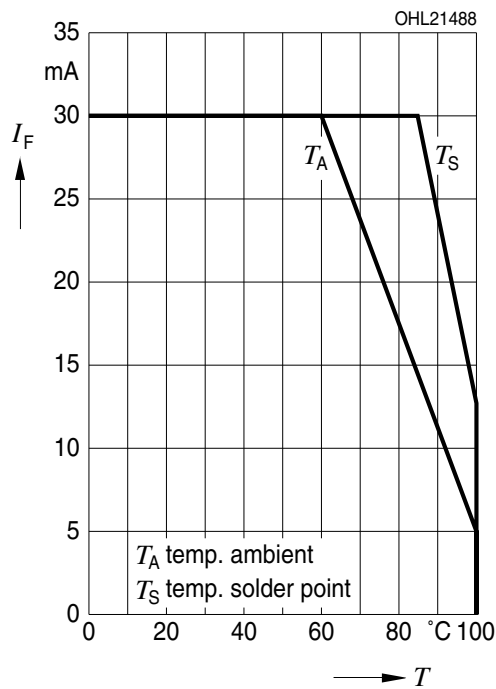

### Permissible Pulse Handling Capability

$I_F = f(t_p)$ ;  $D$ : Duty cycle;  $T_A = 25\text{ °C}$

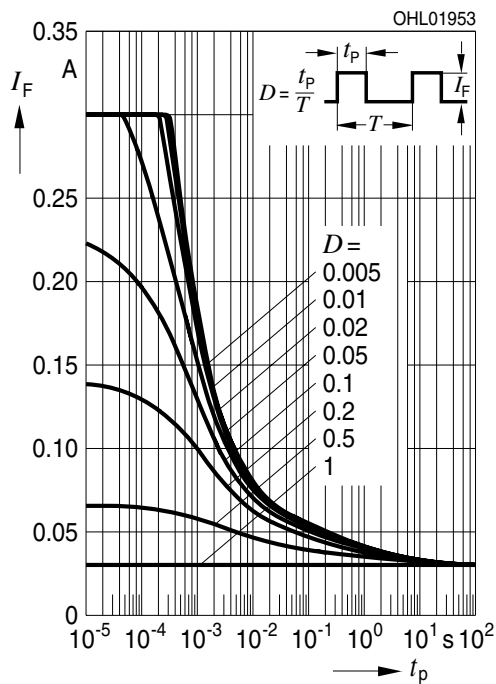

### Permissible Pulse Handling Capability

$I_F = f(t_p)$ ;  $D$ : Duty cycle;  $T_A = 85\text{ °C}$

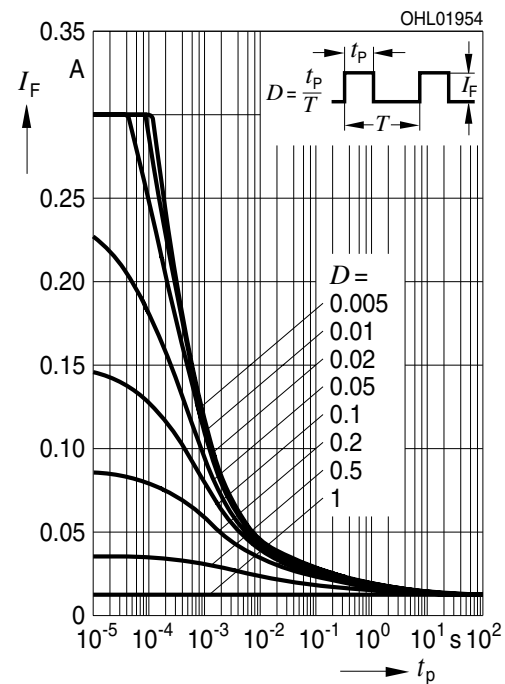

Discontinued

## Dimensional Drawing <sup>9)</sup>

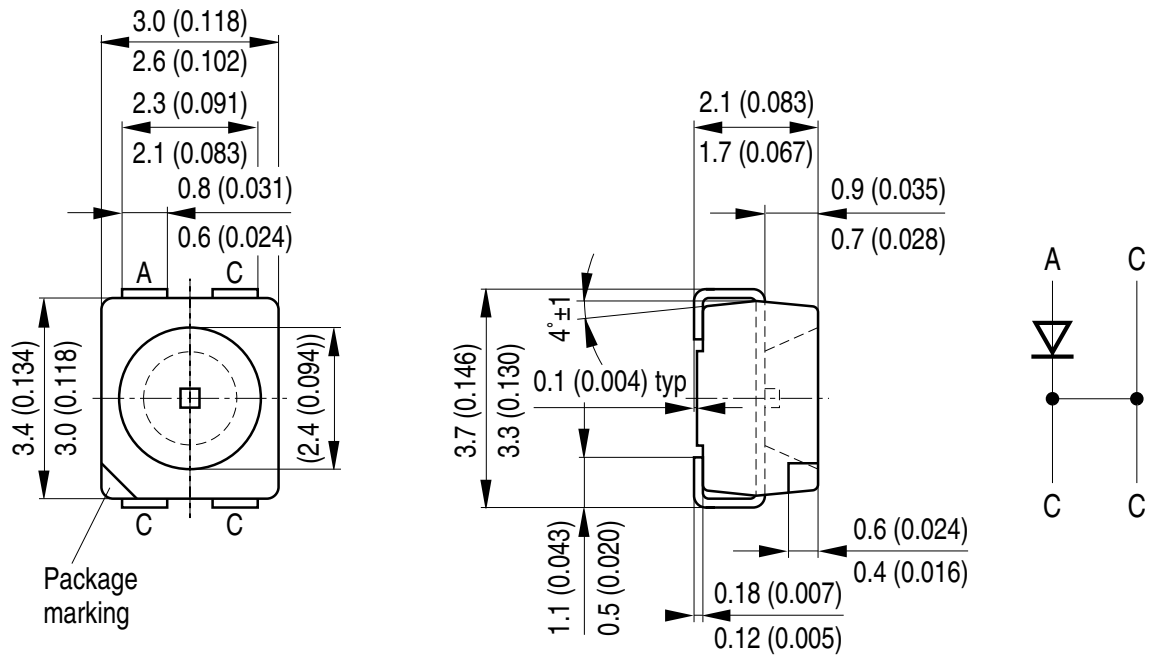

GPLY6991

## Further Information

**Approximate Weight:** 30.0 mg

**Package marking:** Cathode

**Corrosion test:** Class: 3B

Test condition: 40°C / 90 % RH / 15 ppm H<sub>2</sub>S / 14 days (stricter than IEC 60068-2-43)

Recommended Solder Pad <sup>9)</sup>

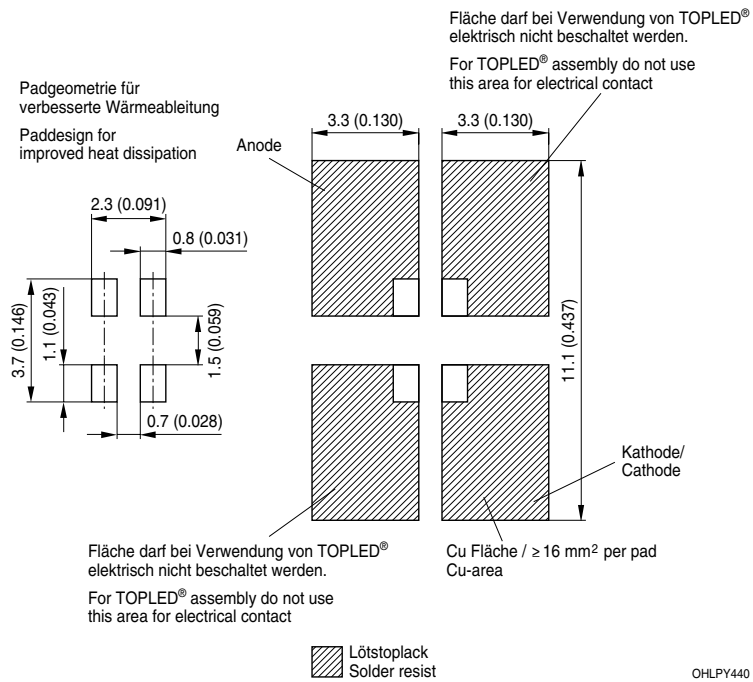

For superior solder joint connectivity results we recommend soldering under standard nitrogen atmosphere. Package not suitable for ultra sonic cleaning.

## Reflow Soldering Profile

Product complies to MSL Level 2 acc. to JEDEC J-STD-020E

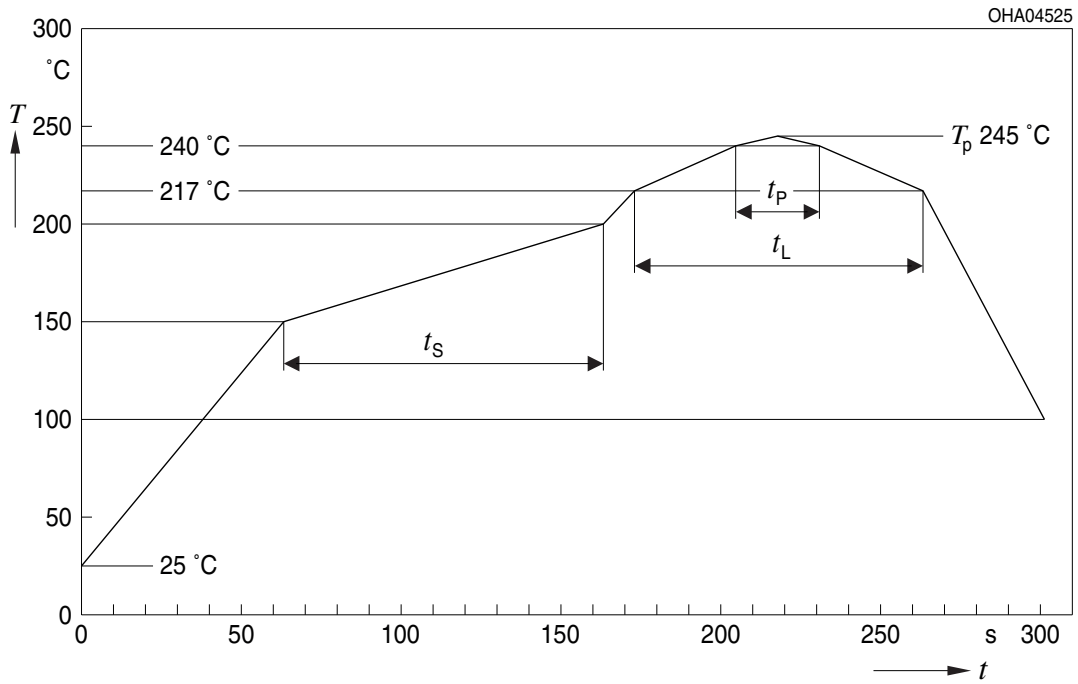

| Profile Feature  | Symbol | Pb-Free (SnAgCu) Assembly |                |         | Unit |
|--|--------|---------------------------|----------------|---------|------|
|  |        | Minimum                   | Recommendation | Maximum |      |
| Ramp-up rate to preheat <sup>*)</sup><br>25 °C to 150 °C       |        |                           | 2              | 3       | K/s  |
| Time $t_s$<br>$T_{Smin}$ to $T_{Smax}$                         | $t_s$  | 60                        | 100            | 120     | s    |
| Ramp-up rate to peak <sup>*)</sup><br>$T_{Smax}$ to $T_p$      |        |                           | 2              | 3       | K/s  |
| Liquidus temperature   | $T_L$  |                           | 217            |         | °C   |
| Time above liquidus temperature                                | $t_L$  |                           | 80             | 100     | s    |
| Peak temperature   | $T_p$  |                           | 245            | 260     | °C   |
| Time within 5 °C of the specified peak temperature $T_p - 5$ K | $t_p$  | 10                        | 20             | 30      | s    |
| Ramp-down rate*<br>$T_p$ to 100 °C                             |        |                           | 3              | 6       | K/s  |
| Time<br>25 °C to $T_p$   |        |                           |                | 480     | s    |

All temperatures refer to the center of the package, measured on the top of the component  
 \*) slope calculation  $DT/Dt$ :  $Dt$  max. 5 s; fulfillment for the whole T-range

Discontinued

Taping <sup>9)</sup>

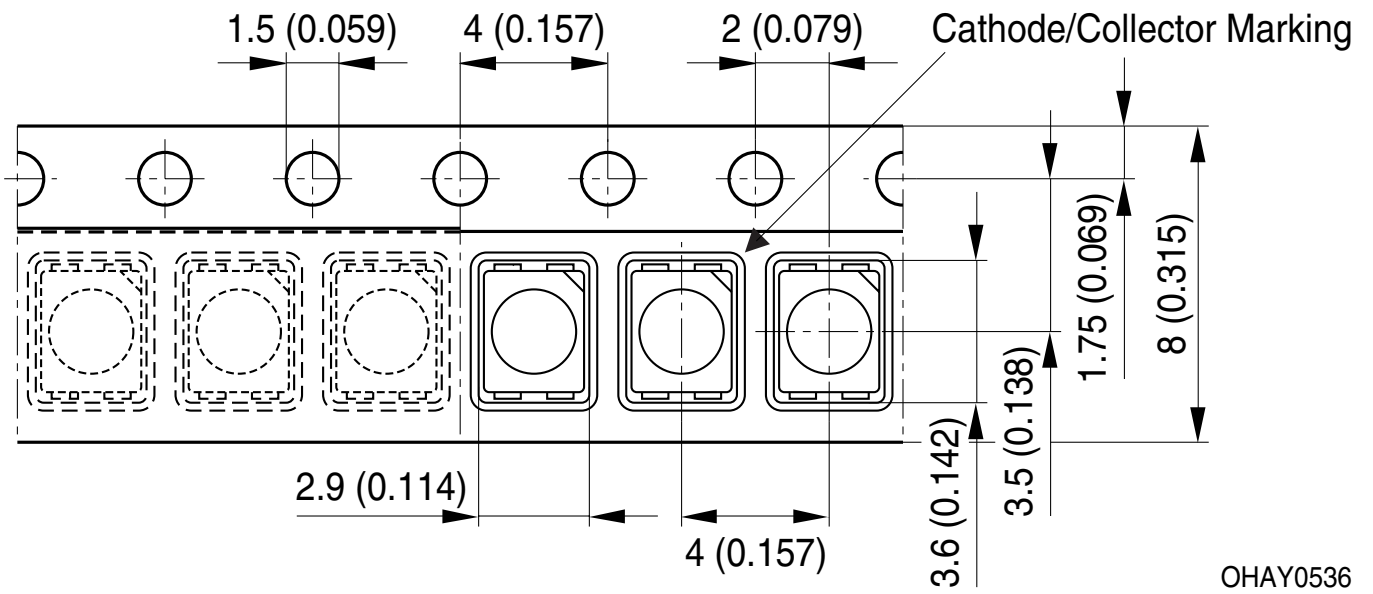

Discontinued

**Tape and Reel** <sup>10)</sup>



**Reel Dimensions**

| A      | W                  | $N_{min}$ | $W_1$      | $W_{2max}$ | Pieces per PU |
|--------|--------------------|-----------|------------|------------|---------------|
| 180 mm | 8 + 0.3 / - 0.1 mm | 60 mm     | 8.4 + 2 mm | 14.4 mm    | 2000          |
| 330 mm | 8 + 0.3 / - 0.1 mm | 60 mm     | 8.4 + 2 mm | 14.4 mm    | 8000          |

### Barcode-Product-Label (BPL)

**OSRAM Opto Semiconductors** LX XXXX BIN1: XX-XX-X-XXX-X

RoHS Compliant

(6P) BATCH NO: 1234567890 ML Temp ST  
X XXX °C X

(1T) LOT NO: 1234567890 (9D) D/C: 1234 Pack: RXX  
DEMY XXX  
X\_X123\_1234.1234 X

(X) PROD NO: 123456789(Q)QTY: 9999 (G) GROUP: XX-XX-X-X

The diagram shows a rectangular label with rounded corners. It contains the OSRAM logo and product name at the top left. To the right are fields for 'LX XXXX' and 'BIN1: XX-XX-X-XXX-X'. Below the logo is 'RoHS Compliant'. The label features three horizontal barcode sections. The first is labeled '(6P) BATCH NO: 1234567890' and is accompanied by a 'No moisture' symbol and 'ML Temp ST X XXX °C X'. The second is labeled '(1T) LOT NO: 1234567890' and '(9D) D/C: 1234', with 'Pack: RXX', 'DEMY XXX', and 'X\_X123\_1234.1234 X' below it. The third is labeled '(X) PROD NO: 123456789(Q)QTY: 9999' and '(G) GROUP: XX-XX-X-X'. A QR code is located on the right side of the label.

OHA04563

### Dry Packing Process and Materials <sup>9)</sup>



OHA00539

Moisture-sensitive product is packed in a dry bag containing desiccant and a humidity card according JEDEC-STD-033.

Discontinued



## Schematic Transportation Box <sup>9)</sup>

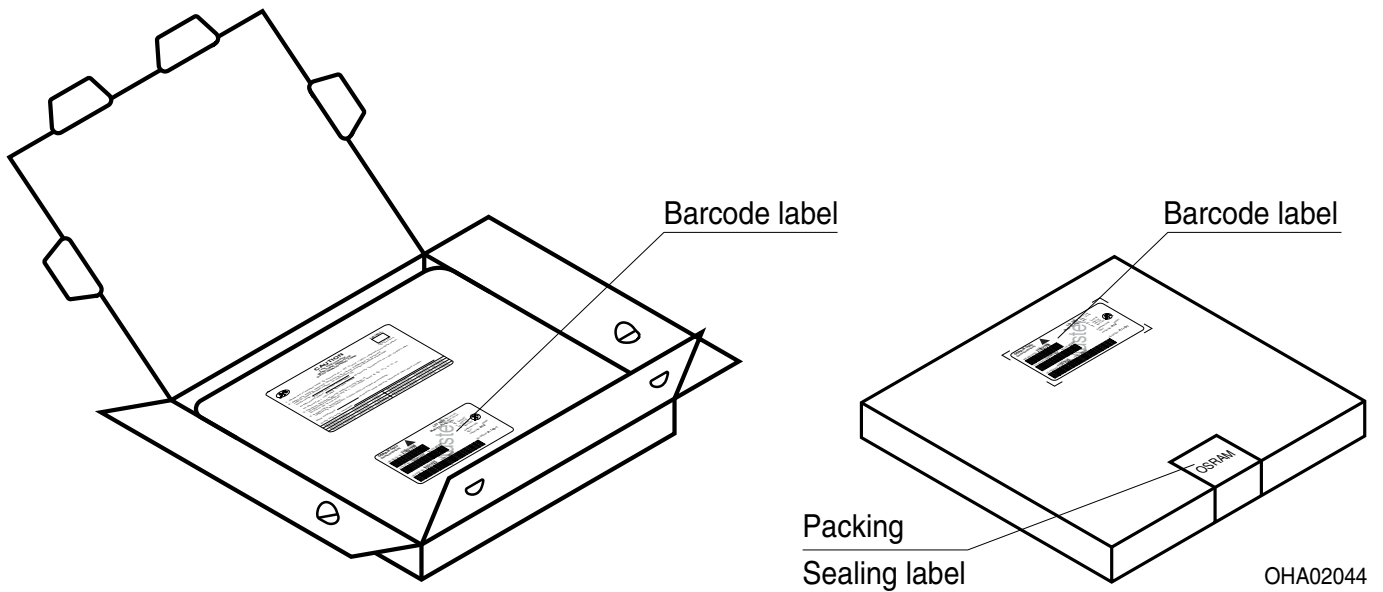

## Dimensions of Transportation Box

| Width      | Length     | Height    |
|------------|------------|-----------|
| 200 ± 5 mm | 195 ± 5 mm | 30 ± 5 mm |
| 352 ± 5 mm | 352 ± 5 mm | 33 ± 5 mm |

---

## Notes

The evaluation of eye safety occurs according to the standard IEC 62471:2006 (photo biological safety of lamps and lamp systems). Within the risk grouping system of this IEC standard, the device specified in this data sheet falls into the class **exempt group (exposure time 10000 s)**. Under real circumstances (for exposure time, conditions of the eye pupils, observation distance), it is assumed that no endangerment to the eye exists from these devices. As a matter of principle, however, it should be mentioned that intense light sources have a high secondary exposure potential due to their blinding effect. When looking at bright light sources (e.g. headlights), temporary reduction in visual acuity and afterimages can occur, leading to irritation, annoyance, visual impairment, and even accidents, depending on the situation.

Subcomponents of this device contain, in addition to other substances, metal filled materials including silver. Metal filled materials can be affected by environments that contain traces of aggressive substances. Therefore, we recommend that customers minimize device exposure to aggressive substances during storage, production, and use. Devices that showed visible discoloration when tested using the described tests above did show no performance deviations within failure limits during the stated test duration. Respective failure limits are described in the IEC60810.

For further application related information please visit [www.osram-os.com/appnotes](http://www.osram-os.com/appnotes)

## Disclaimer

### Attention please!

The information describes the type of component and shall not be considered as assured characteristics. Terms of delivery and rights to change design reserved. Due to technical requirements components may contain dangerous substances.

For information on the types in question please contact our Sales Organization.

If printed or downloaded, please find the latest version on the OSRAM OS website.

### Packing

Please use the recycling operators known to you. We can also help you – get in touch with your nearest sales office. By agreement we will take packing material back, if it is sorted. You must bear the costs of transport. For packing material that is returned to us unsorted or which we are not obliged to accept, we shall have to invoice you for any costs incurred.

### Product and functional safety devices/applications or medical devices/applications

OSRAM OS components are not developed, constructed or tested for the application as safety relevant component or for the application in medical devices.

OSRAM OS products are not qualified at module and system level for such application.

In case buyer – or customer supplied by buyer – considers using OSRAM OS components in product safety devices/applications or medical devices/applications, buyer and/or customer has to inform the local sales partner of OSRAM OS immediately and OSRAM OS and buyer and /or customer will analyze and coordinate the customer-specific request between OSRAM OS and buyer and/or customer.

---

## Glossary

- 1) **Brightness:** Brightness values are measured during a current pulse of typically 25 ms, with an internal reproducibility of  $\pm 8\%$  and an expanded uncertainty of  $\pm 11\%$  (acc. to GUM with a coverage factor of  $k = 3$ ).
- 2) **Reverse Operation:** Reverse Operation of 10 hours is permissible in total. Continuous reverse operation is not allowed.
- 3) **Wavelength:** The wavelength is measured at a current pulse of typically 25 ms, with an internal reproducibility of  $\pm 0.5$  nm and an expanded uncertainty of  $\pm 1$  nm (acc. to GUM with a coverage factor of  $k = 3$ ).
- 4) **Forward Voltage:** The forward voltage is measured during a current pulse of typically 8 ms, with an internal reproducibility of  $\pm 0.05$  V and an expanded uncertainty of  $\pm 0.1$  V (acc. to GUM with a coverage factor of  $k = 3$ ).
- 5) **Thermal Resistance:**  $R_{th\ max}$  is based on statistic values ( $6\sigma$ ).
- 6) **Thermal Resistance:**  $R_{thJA}$  results from mounting on PC board FR 4 (pad size 16 mm<sup>2</sup> per pad)
- 7) **Typical Values:** Due to the special conditions of the manufacturing processes of semiconductor devices, the typical data or calculated correlations of technical parameters can only reflect statistical figures. These do not necessarily correspond to the actual parameters of each single product, which could differ from the typical data and calculated correlations or the typical characteristic line. If requested, e.g. because of technical improvements, these typ. data will be changed without any further notice.
- 8) **Characteristic curve:** In the range where the line of the graph is broken, you must expect higher differences between single devices within one packing unit.
- 9) **Tolerance of Measure:** Unless otherwise noted in drawing, tolerances are specified with  $\pm 0.1$  and dimensions are specified in mm.
- 10) **Tape and Reel:** All dimensions and tolerances are specified acc. IEC 60286-3 and specified in mm.

## Revision History

| Version | Date       | Change       |
|---------|------------|--------------|
| 1.6     | 2019-07-15 | Discontinued |

---

**Published by OSRAM Opto Semiconductors GmbH** EU RoHS and China RoHS compliant product  
**Leibnizstraße 4, D-93055 Regensburg**  
**www.osram-os.com © All Rights Reserved.**



此产品符合欧盟 RoHS 指令的要求；  
按照中国的相关法规和标准，不含有毒有害物质或元素。