

Geofind™ (NN01-103) – GPS/GLONASS/ BeiDou (1561 MHz, 1575 MHz and 1598-1606 MHz)

Geofind[™] (NN01-103) – GPS/GLONASS/BeiDou (1561 MHz, 1575 MHz and 1598-1606 MHz)

Ignion specializes in enabling effective mobile communications. Using Ignion technology, we design and manufacture optimized antennas to make your wireless devices more competitive. Our mission is to help our clients develop innovative products and accelerate their time to market through our expertise in antenna design, testing and manufacturing.

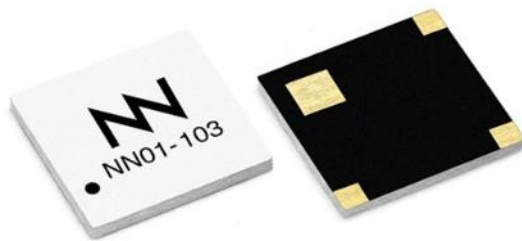

Geofind[™]

NN01-103

Ignion products are protected by [Ignion patents](#).

All information contained within this document is property of Ignion and is subject to change without prior notice. Information is provided “as is” and without warranties. It is prohibited to copy or reproduce this information without prior approval.

Ignion is an ISO 9001:2015 certified company. All our antennas are lead-free and RoHS compliant.

ISO 9001:2015 Certified



INDEX OF CHAPTERS

1. ANTENNA DESCRIPTION	5
2. QUICK REFERENCE GUIDE	5
3. ELECTRICAL PERFORMANCE	6
4. MECHANICAL CHARACTERISTICS	10
5. ASSEMBLY PROCESS	11
6. PACKAGING	14
7. PRODUCT CHANGE NOTIFICATION	15

TABLE OF CONTENTS

1. ANTENNA DESCRIPTION	5
2. QUICK REFERENCE GUIDE	5
3. ELECTRICAL PERFORMANCE	6
3.1. EVALUATION BOARD	6
3.2. MATCHING NETWORK	6
3.3. VSWR AND EFFICIENCY	7
3.4. RADIATION PATTERNS, GAIN AND EFFICIENCY	8
3.5. CAPABILITIES AND MEASUREMENT SYSTEMS	9
4. MECHANICAL CHARACTERISTICS	10
4.1. DIMENSIONS AND TOLERANCES	10
4.2. SPECIFICATIONS FOR THE INK	10
4.3. ANTENNA FOOTPRINT	11
5. ASSEMBLY PROCESS	11
6. PACKAGING	14
7. PRODUCT CHANGE NOTIFICATION	15

1. ANTENNA DESCRIPTION

The Geofind™ chip antenna is specifically engineered for low cost, consumer electronics mobile devices for GPS (1575 MHz), GLONASS (1598-1606 MHz), and BeiDou (1561 MHz).

The Geofind™ chip antenna uses space-filling properties of Ignion technology to minimise its size and cost while maintaining a high radiation efficiency value. This monopole antenna performs an omnidirectional radiation pattern, allowing it to work effectively regardless of the position of the GPS/GLONASS/BeiDou device.



Material: The Geofind™ antenna is built on glass epoxy substrate.

APPLICATIONS

- Metering (Gas, Electricity, Water...)
- RFID (UHF Tags, Readers...)
- Sensors (Parking, Speed control, Optics...)
- Modules Zigbee
- Gateways

BENEFITS

- High efficiency and gain
- Cost-effective
- Small size
- Easy to use (pick and place)

2. QUICK REFERENCE GUIDE

Technical Features	1561 MHz	1575 MHz	1598 – 1606 MHz
Antenna Efficiency	> 70.0 %	> 70.0 %	> 70.0 %
Peak Gain	1.4 dBi	1.2 dBi	1.3 dBi
VSWR	< 2:1		
Radiation Pattern	Omnidirectional		
Polarization	Linear		
Weight (approx.)	0.2 g		
Temperature	-40 to +125° C		
Impedance	50 Ω		
Dimensions (L x W x H)	10.0 mm x 10.0 mm x 0.9 mm		

Table 1 – Technical Features. Measures from the evaluation board. See Figure 1 and picture in page 8.

Please contact support@ignion.io if you require additional information on antenna integration or optimization on your PCB.

3. ELECTRICAL PERFORMANCE

3.1. EVALUATION BOARD

The Ignion configuration used in testing the Geofind[™] Embedded Antenna is displayed in Figure 1.

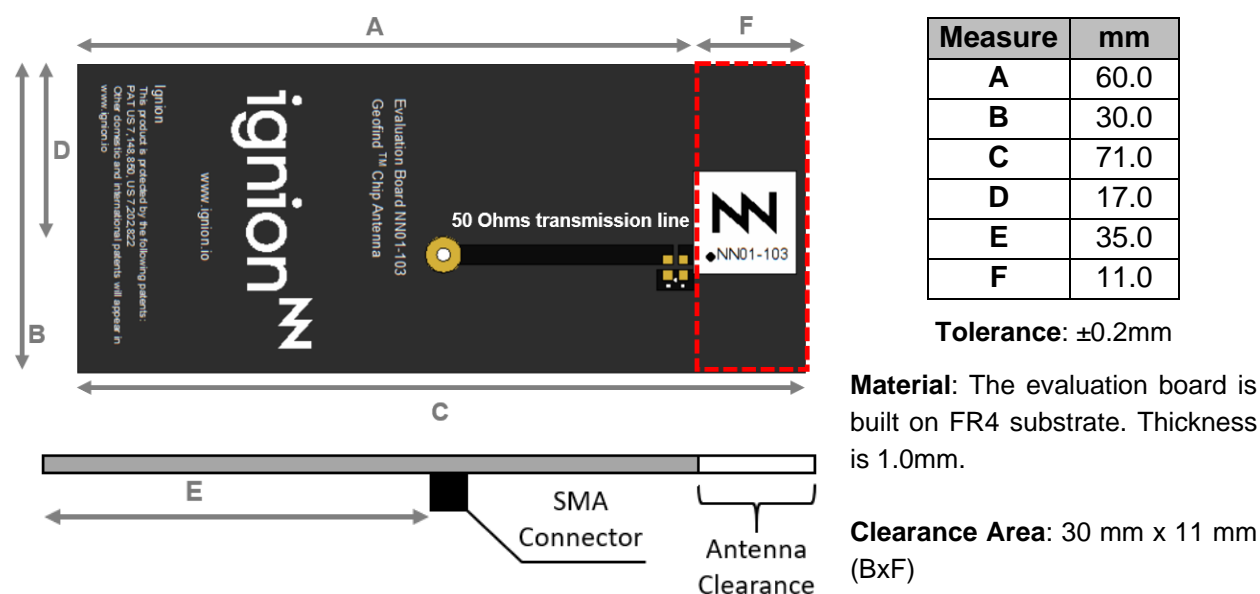

Figure 1 – EB_NN01-103. Geofind[™] Evaluation Board.

3.2. MATCHING NETWORK

The specs of a Ignion standard antenna are measured in their evaluation board, which is an ideal case. In a real design, components nearby the antenna, LCD's, batteries, covers, connectors, etc. affect the antenna performance. This is the reason why it is highly recommended placing pads compatible with 0402 and 0603 SMD components for a PI matching network as close as possible to the antenna feeding point. Do it in the ground plane area, not in the clearance area. This is a degree of freedom to tune the antenna once the design is finished and considering all elements of the system (batteries, displays, covers, etc.).

Please notice that different devices with different ground planes and different components nearby the Geofind[™] chip antenna may need a different matching network. To ensure optimal results, the use of high Q and tight tolerance components is highly recommended (Murata components). If you need assistance to design your matching network beyond this application note, please contact support@ignion.io, or try our free-of-charge¹ **NN Wireless Fast-Track** design service, you will get your chip antenna design including a custom matching network for your device in 24h¹. Other related to NN's range of R&D services is available at: <https://www.ignion.io/rdservices/>

¹ See terms and conditions for a free NN Wireless Fast-Track service in 24h at: <https://www.ignion.io/fast-track-project/>

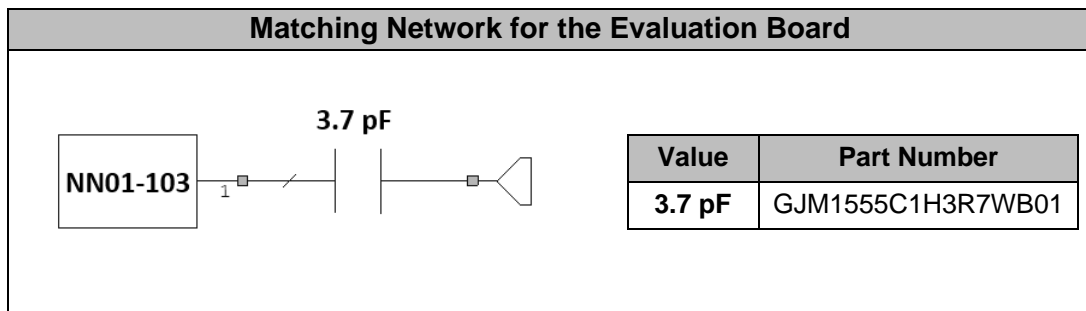

Figure 2 – Matching network implemented in the evaluation board (Figure 1).

3.3. VSWR AND EFFICIENCY

VSWR (Voltage Standing Wave Ratio) and Total Efficiency versus Frequency (GHz).

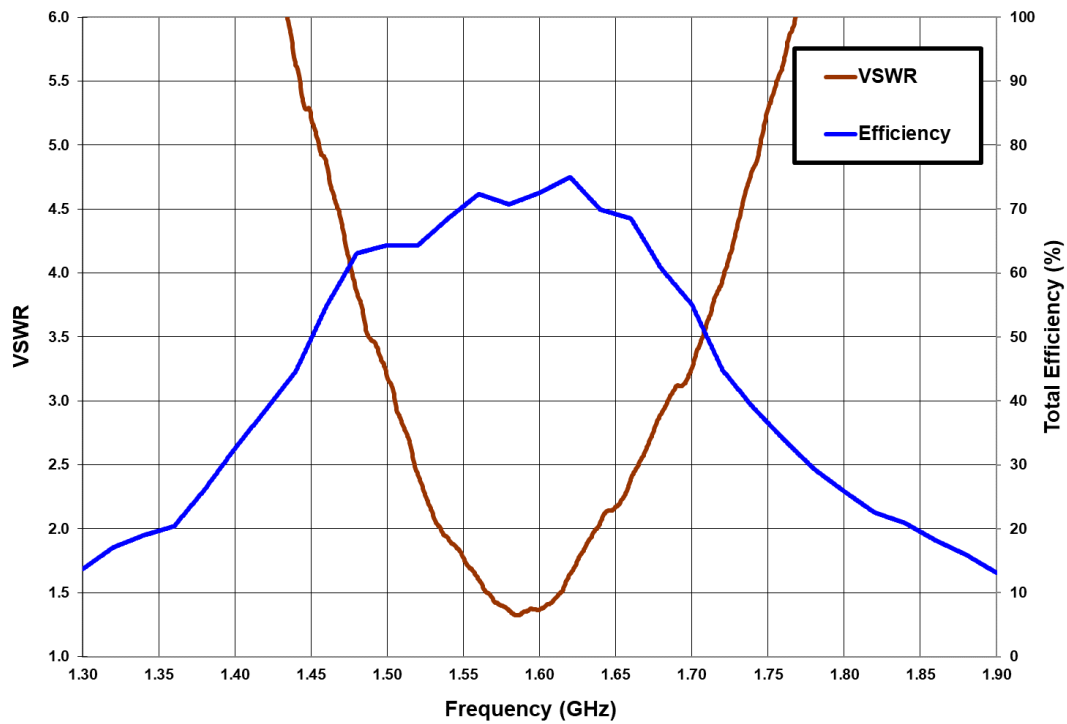
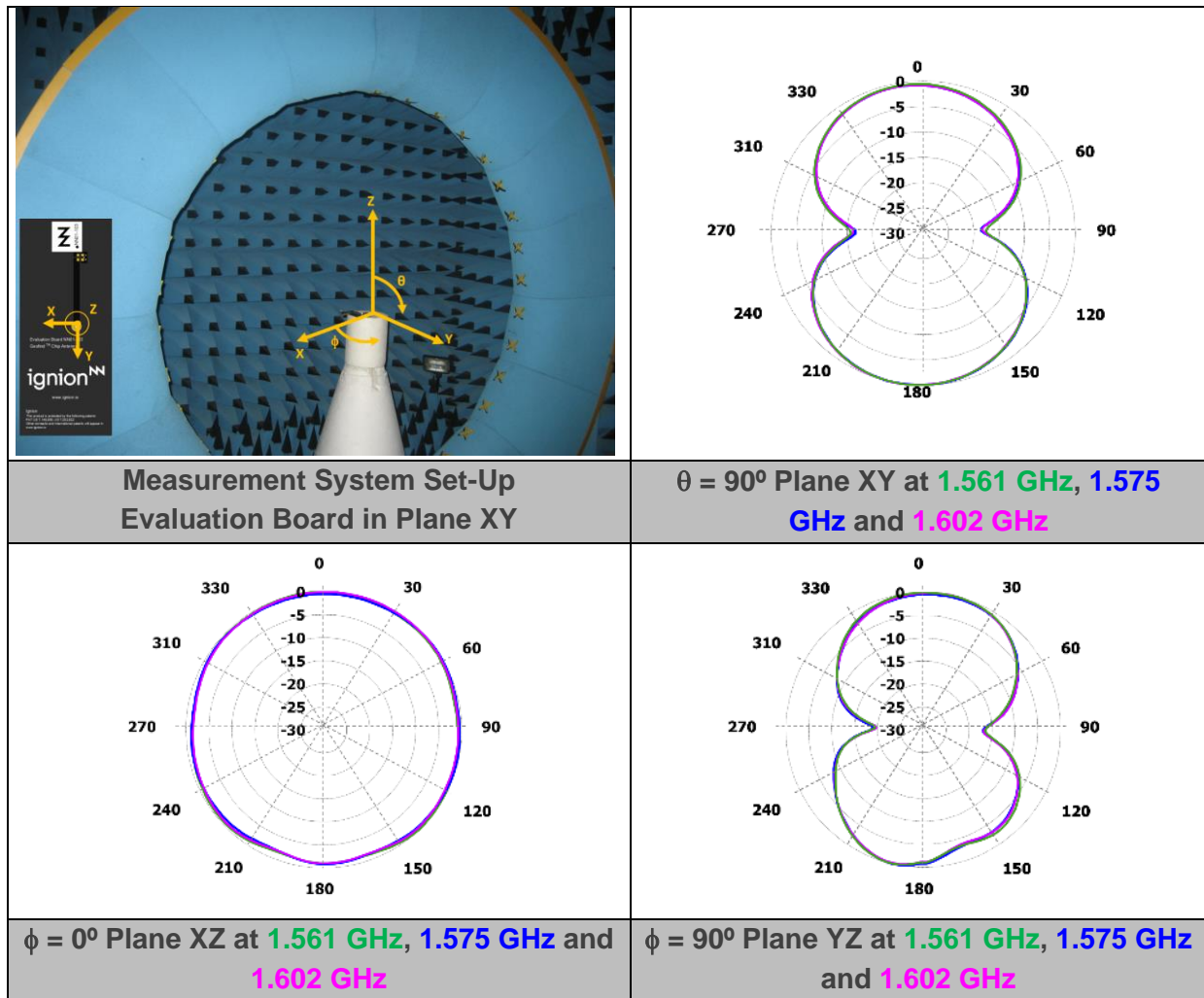

Figure 3 – VSWR and Efficiency (%) vs. Frequency (GHz).

3.4. RADIATION PATTERNS, GAIN AND EFFICIENCY



BeiDou	Gain	1.4 dBi	
	Efficiency	72.3 %	
GPS	Gain	1.2 dBi	
	Efficiency	72.0 %	
GLONASS	Gain	Peak Gain	1.3 dBi
		Average Gain across the band	1.2 dBi
		Gain Range across the band (min, max)	1.2 \leftrightarrow 1.3 dBi
	Efficiency	Peak Efficiency	73.3 %
		Average Efficiency across the band	72.8 %
		Efficiency Range across the band (min, max)	72.4 – 73.3 %

Table 2 – Antenna Gain and Total Efficiency from the evaluation board (Figure 1) for BeiDou (1561 MHz), GPS (1575 MHz) and GLONASS (1598-1606 MHz) bands. Measures made in the Satimo STARGATE 32 anechoic chamber.

3.5. CAPABILITIES AND MEASUREMENT SYSTEMS

Ignion specializes in the design and manufacture of optimized antennas for wireless applications, and with the provision of RF expertise to a wide range of clients. We offer turn-key antenna products and antenna integration support to minimize your time requirements and maximize return on investment throughout the product development process. We also provide our clients with the opportunity to leverage our in-house testing and measurement facilities to obtain accurate results quickly and efficiently.



Agilent E5071B

VSWR
&
S Parameters

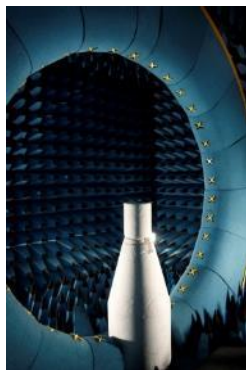
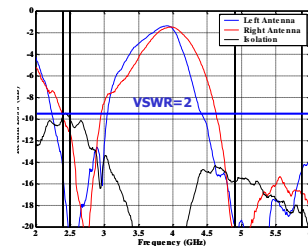

SATIMO STARGATE 32

Radiation
Pattern
&
Efficiency

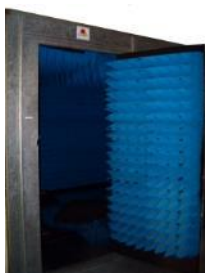
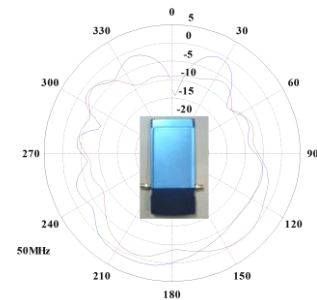

Anechoic chambers and full equipped in-house lab

4. MECHANICAL CHARACTERISTICS

4.1. DIMENSIONS AND TOLERANCES

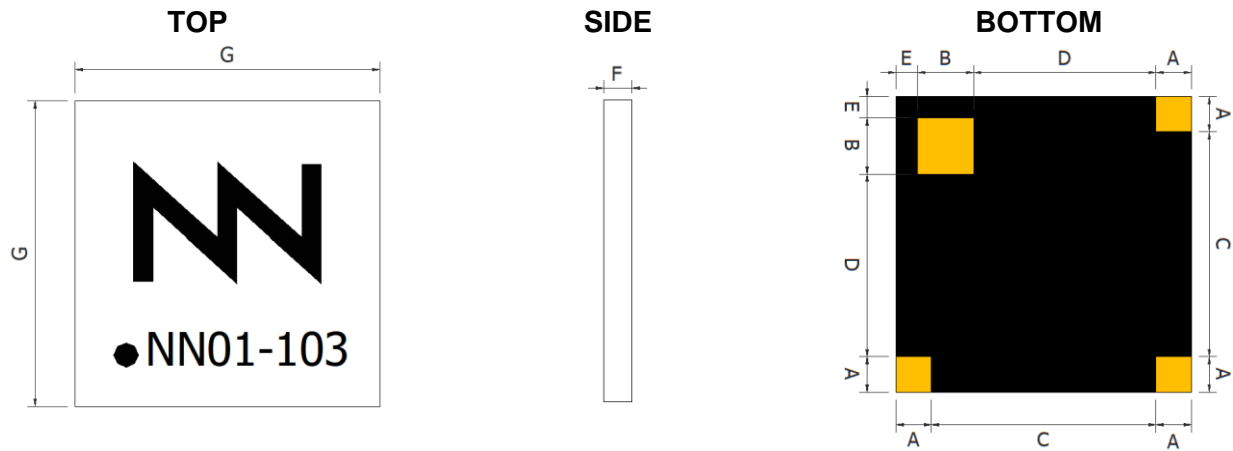

The black dot located on the top side of the antenna indicates the feed pad.

Measure	mm	Measure	mm
A	1.2 ± 0.1	E	0.71 ± 0.15
B	1.9 ± 0.1	F	0.9 ± 0.2
C	7.6 ± 0.2	G	10.0 ± 0.2
D	6.2 ± 0.2		

Figure 4 – Antenna Dimensions and Tolerances.

The Geofind™ chip antenna is compliant with the restriction of the use of hazardous substances (RoHS). The RoHS certificate can be downloaded from www.ignion.io.

4.2. SPECIFICATIONS FOR THE INK

Next figure shows the correct colors of the antenna:

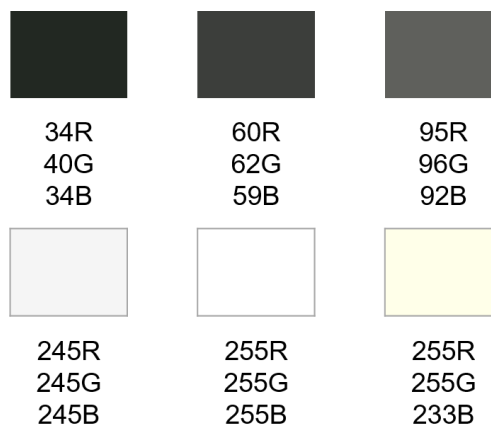

Acceptable color range

4.3. ANTENNA FOOTPRINT

This antenna footprint applies for the reference evaluation board described on page 6 of this User Manual.

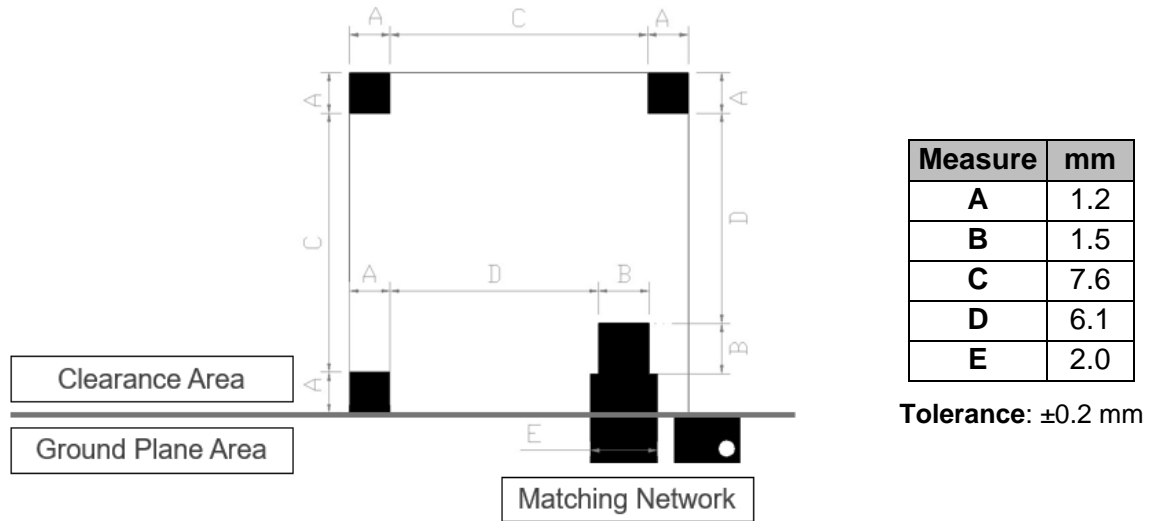

Figure 5 – Antenna Footprint Details.

Other PCB form factors and configurations may require a different feeding configuration, feeding line dimensions and clearance areas. If you require support for the integration of the antenna in your design, please contact support@ignion.io.

5. ASSEMBLY PROCESS

Mounting Pads (2, 3, 4): solder the antenna mounting pads to the soldering pads on the PCB. These pads must NOT be grounded.



Feed Pad (1): the black circle on the top of the antenna indicates the position of the feed pad in the bottom. Align the feed point with the feeding line on the PCB. See Figure 1.

Figure 2 shows the back and front view of the Geofind™ chip antenna, and indicates the location of the feeding point and the mounting pads:

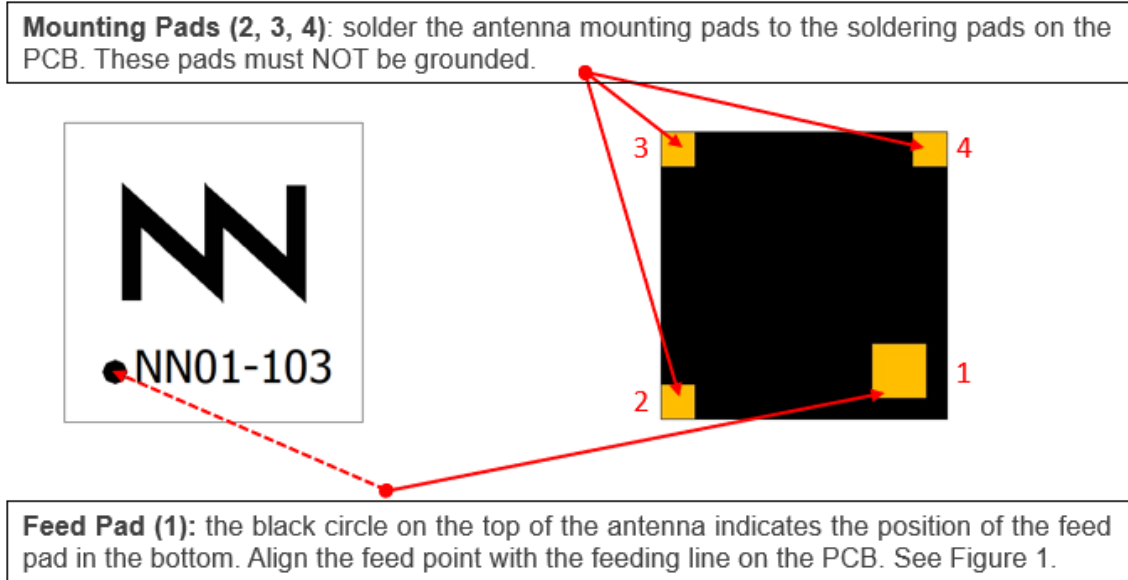

Figure 2 – Pads of the Geofind[™] chip antenna.

As a surface mount device (SMD), this antenna is compatible with industry standard soldering processes. The basic assembly procedure for this antenna is as follows:

1. Apply a solder paste to the pads of the PCB. Place the antenna on the board.
2. Perform a reflow process according to the temperature profile detailed in Figure 4 on page 13.
3. After soldering the antenna to the circuit board, perform a cleaning process to remove any residual flux. Ignion recommends conducting a visual inspection after the cleaning process to verify that all reflux has been removed.

The drawing below shows the soldering details obtained after a correct assembly process:

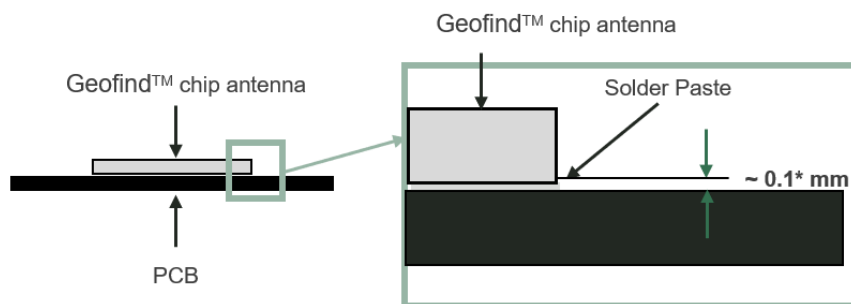

Figure 3 – Soldering Details.

NOTE(*): Solder paste thickness after the assembly process will depend on the thickness of the soldering stencil mask. A stencil thickness equal to or larger than **127 microns (5 mils)** is required.

The Geofind™ chip antenna should be assembled following either Sn-Pb or Pb-free assembly processes. According to the Standard **IPC/JEDEC J-STD-020C**, the temperature profile suggested is as follows:

Phase	Profile features	Pb-Free Assembly (SnAgCu)
RAMP-UP	Avg. Ramp-up Rate (T _{smax} to T _p)	3 °C / second (max.)
PREHEAT	<ul style="list-style-type: none"> - Temperature Min (T_{smin}) - Temperature Max (T_{smax}) - Time (t_{smin} to t_{smax}) 	150 °C 200 °C 60-180 seconds
REFLOW	<ul style="list-style-type: none"> - Temperature (T_L) - Total Time above T_L (t_L) 	217 °C 60-150 seconds
PEAK	<ul style="list-style-type: none"> - Temperature (T_p) - Time (t_p) 	260 °C 20-40 seconds
RAMP-DOWN	Rate	6 °C/second max
Time from 25 °C to Peak Temperature		8 minutes max

Table 3 – Recommended soldering temperatures.

Next graphic shows temperature profile (grey zone) for the antenna assembly process in reflow ovens.

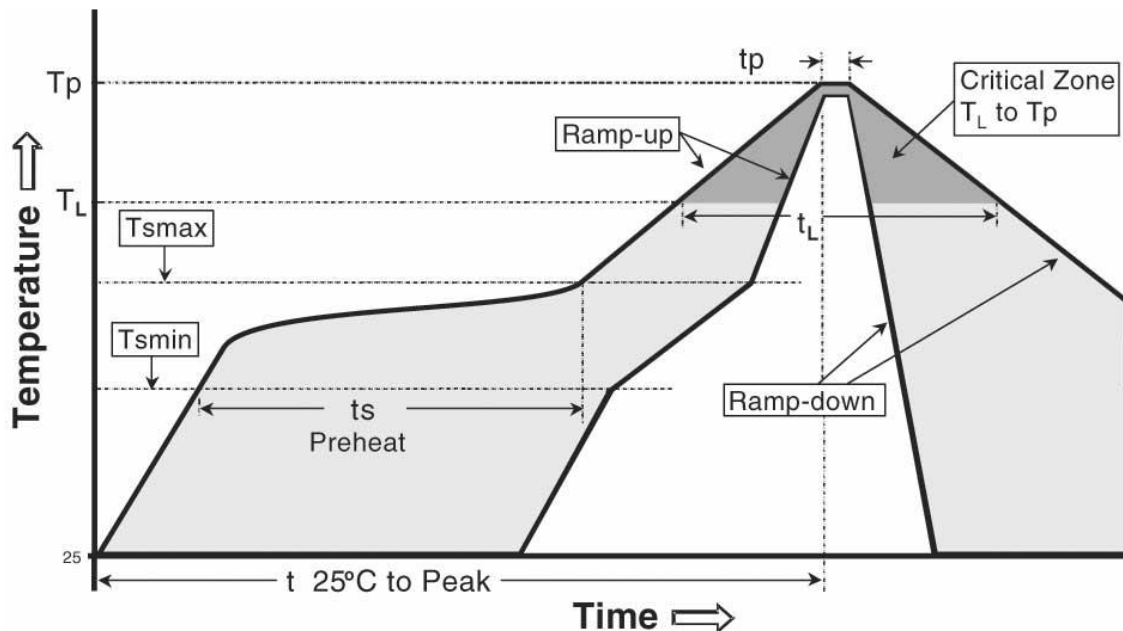
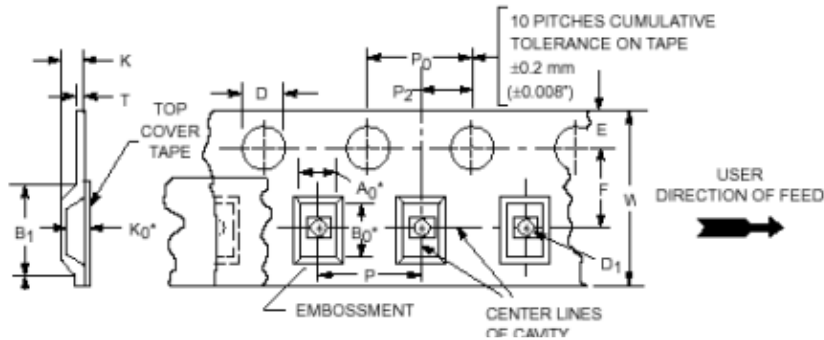

Figure 4 – Temperature profile.

6. PACKAGING

The Geofind[™] chip antenna is available in tape and reel packaging.



Measure	mm
W	16.0 ± 0.3
A0	10.5 ± 0.1
B0	10.5 ± 0.1
K0	1.5 ± 0.1
B1	11.1 ± 0.1
D	2.0 ± 0.1
D1	2.0 ± 0.1
Wmax	16.3
E	1.7 ± 0.1
F	7.5 ± 0.1
K	1.8 ± 0.1
P	12.0 ± 0.1
P0	4.0 ± 0.1
P2	2.0 ± 0.1

Figure 5 – Tape Dimensions and Tolerances.

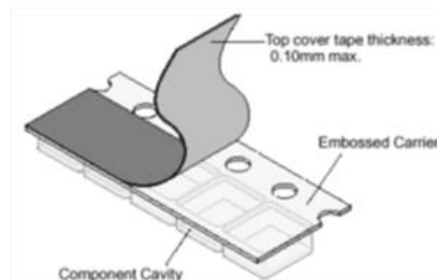
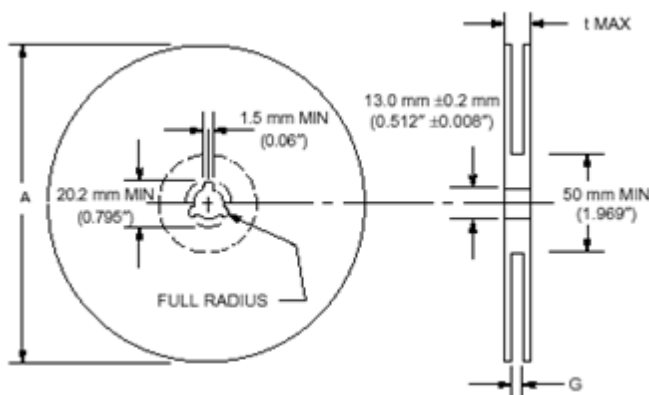

Figure 6 – Images of the tape.



Measure	mm
A max	330.0 ± 1.0
G	17.5 ± 0.2
t max	21.5 ± 0.2

Reel Capacity: 2500 antennas

Figure 7 – Reel Dimensions and Capacity.

7. PRODUCT CHANGE NOTIFICATION

This document is property of Ignion,
Not to disclose or copy without prior written consent

PCN Number: NN19100005

Notification Date: October 07th, 2019

Part Number identification:

Part Number changes, it will be applied in all the document of the company (User Manual, Data Sheet, ...)

Previous Part Number
FR05-S1-E-0-103

New Part Number
NN01-103

Reason for change:

<input type="checkbox"/>	Specs (electrical/mechanical)	<input type="checkbox"/>	Manufacturing location
<input type="checkbox"/>	User Manual/Data Sheet	<input type="checkbox"/>	Quality/Reliability
<input type="checkbox"/>	Material/Composition	<input type="checkbox"/>	Logistics
<input type="checkbox"/>	Processing/Manufacturing	<input checked="" type="checkbox"/>	Other: Logo, product color and Part Number

Change description

- 1.- Part Number: From FR05-S1-E-0-103 FRACTUS to NN01-103 Ignion in the User Manual
- 2.- Logo: From FRACTUS logo to Ignion logo

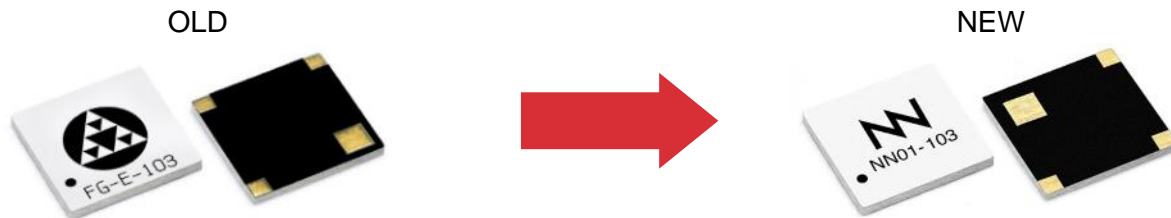

Comments:

- 1.- Electrical and Mechanical specs remain the same
- 2.- Footprint in the PCB to solder the chip antenna remains the same

Identification method

- 1.- In the chip antennas, the changes are in the logo and in the part number

User Manual	<input checked="" type="checkbox"/>	Available from: May 2020
Samples	<input checked="" type="checkbox"/>	Available from: June 2020

Ignion Contact:

Sales
Name: Josep Portabella
Email: josep.portabella@ignion.io

Supply Chain
Albert Vidal
albert.vidal@ignion.io



Your innovation.
Accelerated.

Contact:

support@ignion.io

+34 935 660 710

Barcelona

Av. Alcalde Barnils, 64-68 Modul C, 3a pl.
Sant Cugat del Vallés
08174 Barcelona
Spain

Shanghai

Shanghai Bund Centre
18/F Bund Centre, 222 Yan'an Road East,
Huangpu District
Shanghai, 200002
China

New Delhi

New Delhi, Red Fort Capital Parsvnath Towers
Bhai Veer Singh Marg, Gole Market,
New Delhi, 110001
India

Tampa

8875 Hidden River Parkway
Suite 300
Tampa, FL 33637
USA