

PCB terminal, Wire protection, No. of poles: 5, Width: 17.5 mm, Colour: Dark grey

Business data

Article number	10250.4
Article name	PK 550/5/3,50-V DG
GTIN (EAN)	4044211005627
Packaging unit	50
Quantity unit	PC
Packaging type	Carton
Type of banding	Without
Weight per piece (not including packaging)	2.2 g
Weight per piece (including packaging)	2.67 g
Unit of weight	G
Customs number	85369010
Country of origin	TN
Prio-Article	10250.1

Technical data

Dimensions

Length	6.5 mm
Length of the pin	3.5 mm
Width	17.5 mm
Width left	1.75 mm
Width right	1.75 mm
Height	8.2 mm
Drill hole diameter	1.2 mm
Diameter of connecting pin	0.9 mm
Pitch	3.5 mm

Ratings

Rated voltage	130 V
Rated current	13.5 A
Rated cross-section	1 mm ²
Rated impulse voltage	1.25 kV
Overvoltage category	III
Contamination degree	3

Technical data

Connection data

Connection principle	Wire protection
Connection type of PCB	Solder connection
Type of attachment to circuit board	Connecting contact
Angle of PCB/wire connection	0°/180° (horizontal)
No. of poles	5
Number of levels	1
Wire cross-section single-core (rigid) / stranded, min.	0.08 mm ²
Wire cross-section single core (rigid)/stranded, max.	1.5 mm ²
Wire cross-section stranded, min.	0.08 mm ²
Wire cross-section stranded, max.	1 mm ²
Wire cross-section stranded with wire-end ferrules,min.	0.14 mm ²
Wire cross-section stranded with wire-end ferrules,max.	0.5 mm ²
Wire cross-section AWG, min.	28
Wire cross-section AWG, max.	16
Stripping length	5.5 mm
Screw threading	M 2
Torque	0.2 Nm

Materials

Insulation housing	Polyamide 6.6
Flammability class UL 94	V-0
Working temperature, min.	-30 °C
Working temperature, max.	105 °C
Clamping element	Brass
Screws	Steel
Wire protection	Stainless steel

Technical data

Further technical data

Storage temperature, min.	-40 °C
Storage temperature, max.	105 °C
Insulation resistance	1*10 ¹³ Ohm x cm
Creepage-current resistance	CTI 600
Glow wire flammability index GWFI	GWFI 850
GWFI after-glow time	30 Sek.
Glow wire ignition temperature GWIT	GWIT 775 °C
GWIT exposure time	5 Sek.
Connection cycles, in compliance with standard	5
Recommended wave soldering temperature	260 °C
Recommended wave soldering duration, min.	3 Sek.
Recommended wave soldering duration, max.	4 Sek.

Environmental Product Compliance

REACH Conform	No
REACH Reference date	2022-06-10
REACH Candidate Substance Note	No
REACH CAS 1 Substance	LEAD
REACH CAS 1 Percent minimal	0.1 %
REACH CAS 1 Percent maximum	4 %
REACH CAS 1 Number	7439-92-1
RoHS Conform	yes
RoHS Exception rule	6c

Approvals

cUL Recognized

cUL approval	CSA 22.2 No.158
cUL Usegroup B: rated voltage	125 V
cUL Usegroup B: rated current	6 A
cUL wire cross-section single-core (rigid) AWG, min.	28
cUL wire cross-section single-core (rigid) AWG, max.	16
cUL wire cross-section stranded AWG, min.	16
cUL wire cross-section stranded AWG, max.	28
cUL torque	0.25 Nm
cUL wire material	Cu
cUL Recognized	1

UL Recognized

UL approval	UL 1059
UL Usegroup B: rated voltage	125 V
UL Usegroup B: rated current	6 A
UL wire cross-section single-core (rigid) AWG, min.	28
UL wire cross-section single-core (rigid) AWG, max.	16
UL wire cross-section stranded AWG, min.	16
UL wire cross-section stranded AWG, max.	28
UL torque	2.21 Lb In
UL wire material	Cu
UL factory wiring	1
UL field wiring	1
UL Recognized	1

Approvals

VDE approval

VDE approval	DIN EN 60998
VDE approval granted	yes
VDE rated voltage	130 V
VDE rated current	13.5 A
VDE rated current wire cross-section rigid, max.	13.5 A
VDE rated current wire cross-section stranded, max.	13.5 A
VDE rated impulse voltage	1.25 kV
VDE wire cross-section rigid, min.	0.5 mm ²
VDE wire cross-section rigid, max.	1 mm ²
VDE wire cross-section stranded, min.	0.5 mm ²
VDE wire cross-section stranded, max.	1 mm ²
VDE screw threading	M 2
VDE torque	0.2 Nm
VDE overvoltage category	III
VDE contamination degree	3

Media

M2

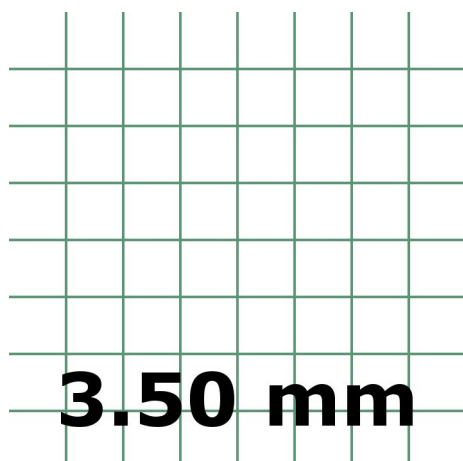
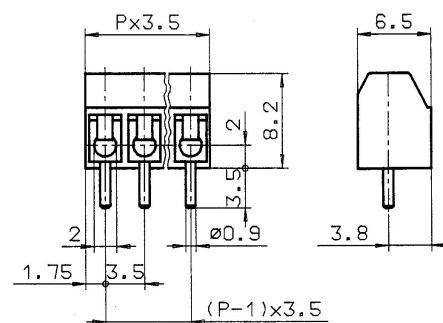

3.50 mm



Accessories
