

## Part Number: D3I7018

### Electrical Specifications

Frequency Range (GHz):	7.0	-	18.0
Isolation (dB):	15	MIN	
Insertion Loss (dB):	1.0	MAX	
VSWR:	1.5:1	MIN	
Forward Power (W):	20	AVG	
	30	PK	
Reflective Power (W):	2	AVG	

### Mechanical/Environmental Specifications

Connector Type:	SMA
Connector Body:	Passivated stainless steel
Connector Pin:	Gold plated copper
Load Body:	Brass
Magnetic Shunt:	Nickel plated CRS
Operational Temp:	-10°C to +85°C
Weight (oz)	0.9 MAX

### D3I7018 Dimensions

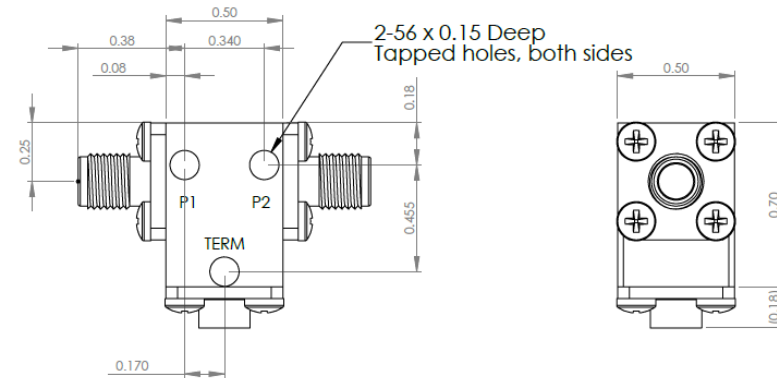

### D3I7018-3 Dimensions

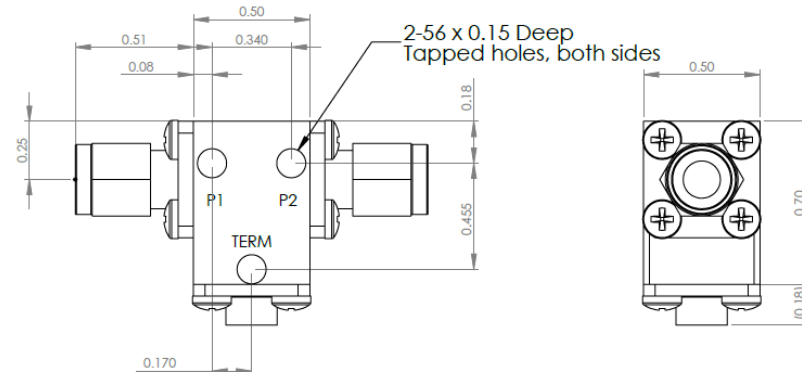

Dimensions are in inches  
Tolerance

XX ±0.03  
XXX ±0.010

Type of Device	PN Suffix	Connector Configuration Input / Output	PN Example
Single and Dual Junction Isolator, 2-Port Device	N/A	Female / Female	D3I7018
	-1	Male / Female	D3I7018-1
	-2	Female / Male	D3I7018-2
	-3	Male / Male	D3I7018-3



# MEASURED DATA

Part Number: D3I7018, +25°C

