

Mounting Option

04-.156 (3.96) Dia. Mounting Holes

Card Slot Accepts
.054 [1.37] to .070 [1.78]
Thick P.C. Board

Contact Detail

542-Wire Wrap .025 Sq.(0.64 Sq.) - Tail LG=.645(16.38)
.156 [3.96] Contact Spacing x .200 [5.08] Row Spacing

THIS IS A C.A.D. GENERATED DRAWING
DO NOT MAKE MANUAL REVISIONS TO MASTER.



ISSUE NUMBER

ORIGINAL ①

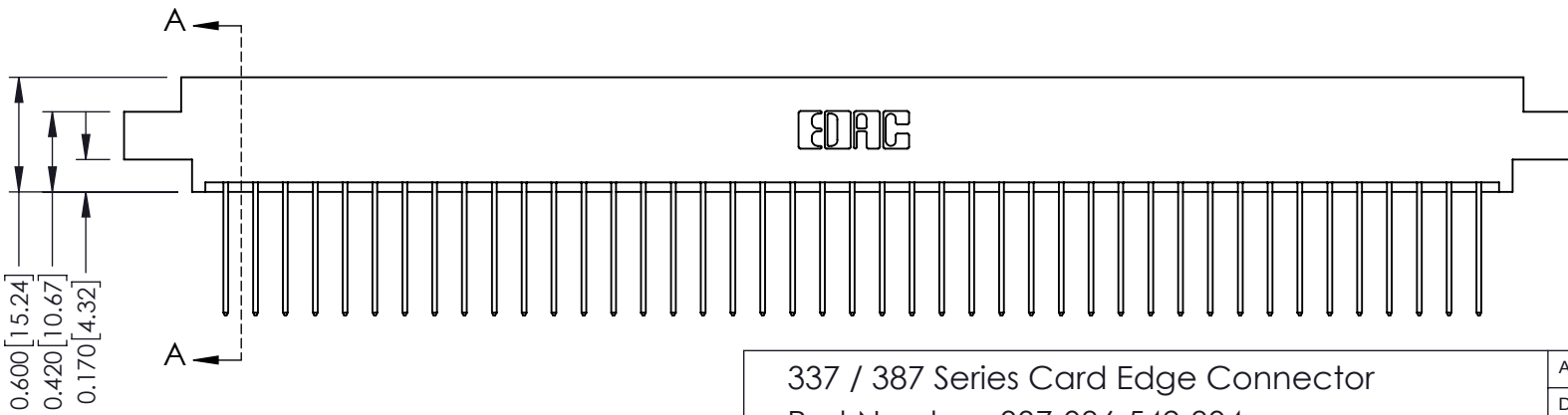
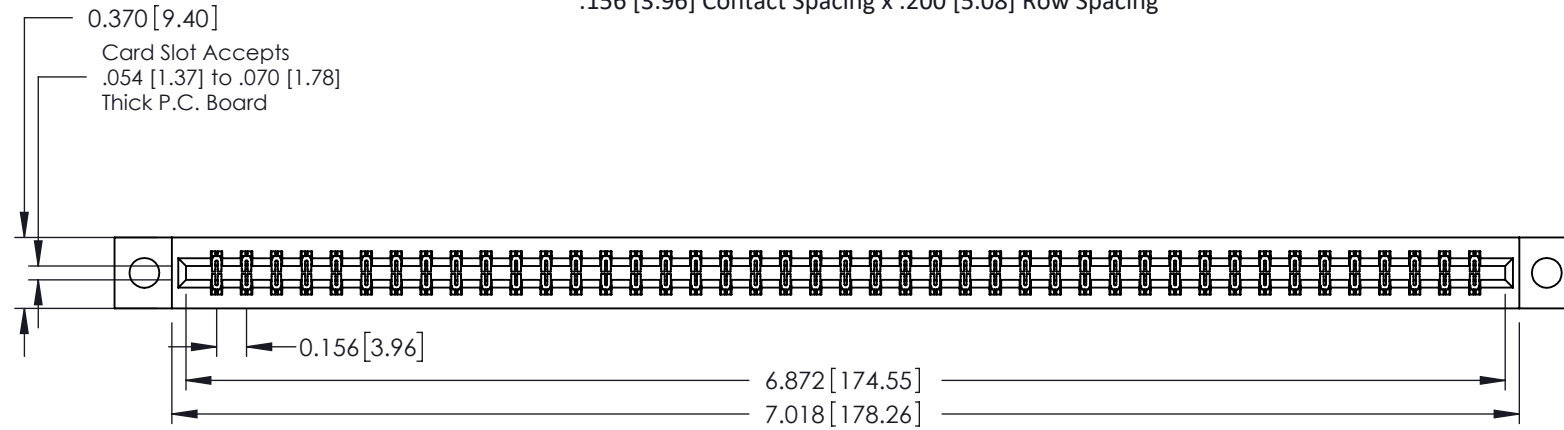

See Accompanying Pages for:

- Contact Bend Details
- Mounting Options

337 / 387 Series Card Edge Connector

Part Number: 337-086-542-804



YOUR CONNECTION TO QUALITY & SERVICE

EDAC INC
TORONTO, ONTARIO
CANADA

THESE DRAWINGS AND SPECIFICATIONS
ARE THE PROPERTY OF EDAC INC. AND
SHALL NOT BE REPRODUCED, OR COPIED
OR USED AS THE BASIS FOR THE
MANUFACTURE OR SALE OF APPARATUS
WITHOUT WRITTEN PERMISSION.

ACAD REFERENCE NO. 337 ENG MASTER

DRAWN: J.LEE DATE: OCT. 06/09

CHECKED: DATE:

SCALE: NTS SHEET 1 OF 3

DRAWING NUMBER 337 Assembly ISSUE 1

THIS IS A C.A.D. GENERATED DRAWING
DO NOT MAKE MANUAL REVISIONS TO MASTER.



ISSUE NUMBER	
ORIGINAL	①



555 Contact Code



556 Contact Code



558 Contact Code



559 Contact Code



560 Contact Code

337 / 387 Series Card Edge Connector Contact Bend Detail



EDAC INC
TORONTO, ONTARIO
CANADA

YOUR CONNECTION TO QUALITY & SERVICE

THESE DRAWINGS AND SPECIFICATIONS
ARE THE PROPERTY OF EDAC INC. AND
SHALL NOT BE REPRODUCED, OR COPIED
OR USED AS THE BASIS FOR THE
MANUFACTURE OR SALE OF APPARATUS
WITHOUT WRITTEN PERMISSION.

ACAD REFERENCE NO. 337 ENG MASTER	
DRAWN: J.LEE	DATE: OCT. 06/09
CHECKED:	DATE:
SCALE: NTS	SHEET 2 OF 3
DRAWING NUMBER 337 Assembly	ISSUE 1

THIS IS A C.A.D. GENERATED DRAWING
DO NOT MAKE MANUAL REVISIONS TO MASTER.



ISSUE NUMBER

ORIGINAL ①



337 / 387 Series Card Edge Connector Mounting Options



YOUR CONNECTION TO QUALITY & SERVICE

EDAC INC
TORONTO, ONTARIO
CANADA

THESE DRAWINGS AND SPECIFICATIONS
ARE THE PROPERTY OF EDAC INC. AND
SHALL NOT BE REPRODUCED, OR COPIED
OR USED AS THE BASIS FOR THE
MANUFACTURE OR SALE OF APPARATUS
WITHOUT WRITTEN PERMISSION.

ACAD REFERENCE NO. 337 ENG MASTER

DRAWN: J.LEE DATE: OCT. 06/09

CHECKED: DATE:

SCALE: NTS SHEET 3 OF 3

DRAWING NUMBER 337 Assembly ISSUE 1