

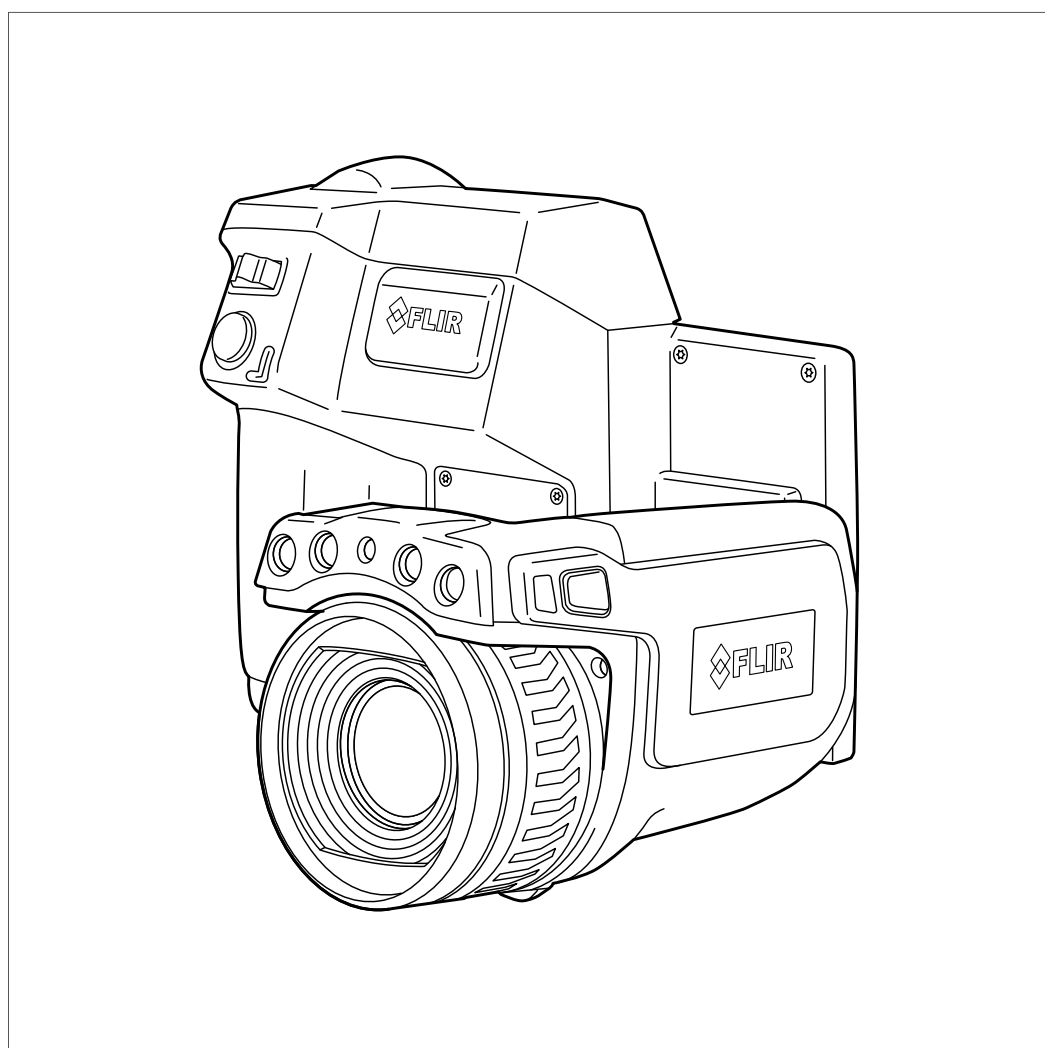

---

# User's manual FLIR T6xx series







**Important note**

Before operating the device, you must read, understand, and follow all instructions, warnings, cautions, and legal disclaimers.

**Důležitá poznámka**

Před použitím zařízení si přečtěte veškeré pokyny, upozornění, varování a vyvázání se ze záruky, ujistěte se, že jim rozumíte, a řiďte se jimi.

**Viktig meddelelse**

Før du betjener enheden, skal du læse, forstå og følge alle anvisninger, advarsler, sikkerhedsforanstaltninger og ansvarsfraskrivelser.

**Wichtiger Hinweis**

Bevor Sie das Gerät in Betrieb nehmen, lesen, verstehen und befolgen Sie unbedingt alle Anweisungen, Warnungen, Vorsichtshinweise und Haftungsausschlüsse

**Σημαντική σημείωση**

Πριν από τη λειτουργία της συσκευής, πρέπει να διαβάσετε, να κατανοήσετε και να ακολουθήσετε όλες τις οδηγίες, προειδοποιήσεις, προφυλάξεις και νομικές αποποιήσεις.

**Nota importante**

Antes de usar el dispositivo, debe leer, comprender y seguir toda la información sobre instrucciones, advertencias, precauciones y renuncias de responsabilidad.

**Tärkeä huomautus**

Ennen laitteen käyttämistä on luettava ja ymmärrettävä kaikki ohjeet, vakavat varoitukset, varoitukset ja lakitiedotteet sekä noudatettava niitä.

**Remarque importante**

Avant d'utiliser l'appareil, vous devez lire, comprendre et suivre l'ensemble des instructions, avertissements, mises en garde et clauses légales de non-responsabilité.

**Fontos megjegyzés**

Az eszköz használatá elött figyelmesen olvassa el és tartsa be az összes utasítást, figyelmeztetést, óvintézkedést és jogi nyilatkozatot.

**Nota importante**

Prima di utilizzare il dispositivo, è importante leggere, capire e seguire tutte le istruzioni, avvertenze, precauzioni ed esclusioni di responsabilità legali.

**重要な注意**

デバイスをご使用になる前に、あらゆる指示、警告、注意事項、および免責条項をお読み頂き、その内容を理解して従ってください。

**중요한 참고 사항**

장치를 작동하기 전에 반드시 다음의 사용 설명서와 경고, 주의사항, 법적 책임제한을 읽고 이해하며 따라야 합니다.

**Viktig**

Før du bruker enheten, må du lese, forstå og følge instruksjoner, advarsler og informasjon om ansvarsfraskrivelse.

**Belangrijke opmerking**

Zorg ervoor dat u, voordat u het apparaat gaat gebruiken, alle instructies, waarschuwingen en juridische informatie hebt doorgelezen en begrepen, en dat u deze opvolgt en in acht neemt.

**Ważna uwaga**

Przed rozpoczęciem korzystania z urządzenia należy koniecznie zapoznać się z wszystkimi instrukcjami, ostrzeżeniami, przestrogami i uwagami prawnymi. Należy zawsze postępować zgodnie z zaleceniami tam zawartymi.

**Nota importante**

Antes de utilizar o dispositivo, deverá proceder à leitura e compreensão de todos os avisos, precauções, instruções e isenções de responsabilidade legal e assegurar-se do seu cumprimento.

**Важное примечание**

До того, как пользоваться устройством, вам необходимо прочитать и понять все предупреждения, предостережения и юридические ограничения ответственности и следовать им.

**Viktig information**

Innan du använder enheten måste du läsa, förstå och följa alla anvisningar, varningar, försiktighetsåtgärder och ansvarsfriskrivningar.

**Önemli not**

Cihazı çalıştırmadan önce tüm talimatları, uyarıları, ikazları ve yasal açıklamaları okumalı, anlamalı ve bunlara uymalısınız.

**重要注意事項**

在操作设备之前，您必须阅读、理解并遵循所有说明、警告、注意事项和法律免责声明。

**重要注意事項**

操作裝置之前，您務必閱讀、了解並遵循所有說明、警告、注意事項與法律免責聲明。





---

# User's manual FLIR T6xx series



# Table of contents

---

<b>1</b>	<b>Disclaimers</b>	<b>1</b>
1.1	Legal disclaimer	1
1.2	Usage statistics	1
1.3	U.S. Government Regulations	1
1.4	Copyright	1
1.5	Quality assurance	1
1.6	Patents	1
1.7	EULA Terms	1
1.8	EULA Terms	1
<b>2</b>	<b>Safety information</b>	<b>2</b>
<b>3</b>	<b>Notice to user</b>	<b>6</b>
3.1	Calibration	6
3.2	Accuracy	6
3.3	Disposal of electronic waste	6
3.4	Training	6
3.5	Documentation updates	6
3.6	Important note about this manual	7
3.7	Note about authoritative versions	7
<b>4</b>	<b>Customer help</b>	<b>8</b>
4.1	General	8
4.2	Submitting a question	8
4.3	Downloads	8
<b>5</b>	<b>Quick start guide</b>	<b>9</b>
5.1	Procedure	9
<b>6</b>	<b>List of accessories and services</b>	<b>10</b>
<b>7</b>	<b>A note about ergonomics</b>	<b>12</b>
7.1	General	12
7.2	Figure	12
<b>8</b>	<b>Camera parts</b>	<b>13</b>
8.1	View from the right	13
8.1.1	Figure	13
8.1.2	Explanation	13
8.2	View from the left	14
8.2.1	Figure	14
8.2.2	Explanation	14
8.3	View from the rear	15
8.3.1	Figure	15
8.3.2	Explanation	15
8.4	View from the bottom	16
8.4.1	Figure	16
8.4.2	Explanation	16
8.5	Battery condition LED indicator	17
8.5.1	Figure	17
8.5.2	Explanation	17
8.6	Power LED indicator	17
8.6.1	Figure	17
8.6.2	Explanation	17
8.7	Laser pointer	18
8.7.1	Figure	18
8.7.2	Laser warning label	18
8.7.3	Laser rules and regulations	18
<b>9</b>	<b>Screen elements</b>	<b>19</b>
9.1	Figure	19
9.2	Explanation	19

## Table of contents

---

<b>10</b>	<b>Navigating the menu system</b> .....	<b>20</b>
10.1	Figure .....	20
10.2	Explanation .....	20
<b>11</b>	<b>Pairing Bluetooth devices</b> .....	<b>21</b>
11.1	General .....	21
11.2	Procedure .....	21
<b>12</b>	<b>Configuring Wi-Fi</b> .....	<b>22</b>
12.1	General .....	22
12.2	Setting up a peer-to-peer connection (most common use) .....	22
12.3	Connecting the camera to a wireless local area network (less common use).....	22
<b>13</b>	<b>Handling the camera</b> .....	<b>23</b>
13.1	Charging the battery .....	23
13.1.1	Using the power supply to charge the battery .....	23
13.1.2	Using the stand-alone battery charger to charge the battery .....	23
13.2	Turning on the camera .....	23
13.2.1	Procedure .....	23
13.3	Turning off the camera .....	23
13.3.1	Procedure .....	23
13.4	Adjusting the viewfinder's dioptic correction .....	24
13.4.1	Figure.....	24
13.4.2	Procedure .....	24
13.5	Adjusting the angle of the lens .....	25
13.5.1	Figure.....	25
13.6	Adjusting the infrared camera focus manually .....	25
13.6.1	Figure.....	25
13.6.2	Procedure .....	25
13.7	Autofocusing the infrared camera .....	26
13.7.1	Figure.....	26
13.7.2	Procedure .....	26
13.8	Continuous autofocus .....	26
13.8.1	General.....	26
13.8.2	Procedure .....	26
13.9	Operating the laser pointer.....	27
13.9.1	Figure.....	27
13.9.2	Procedure .....	27
13.10	Using the digital zoom function .....	28
13.10.1	Figure.....	28
13.10.2	Procedure .....	28
13.11	Changing lenses.....	28
13.12	Calibrating the compass.....	30
13.12.1	Procedure .....	30
13.13	Changing the viewfinder eyecup.....	30
13.14	Using the camera lamp as a flash .....	32
13.14.1	General.....	32
13.14.2	Procedure .....	32
<b>14</b>	<b>Working with images</b> .....	<b>33</b>
14.1	Saving an image .....	33
14.1.1	General.....	33
14.1.2	About UltraMax.....	33
14.1.3	Image capacity .....	33
14.1.4	Naming convention.....	33
14.1.5	Procedure .....	33
14.2	Previewing an image .....	34

## Table of contents

---

14.2.1	General.....	34
14.2.2	Procedure .....	34
14.3	Opening a saved image.....	34
14.3.1	General.....	34
14.3.2	Procedure .....	34
14.4	Editing a saved image.....	34
14.4.1	General.....	34
14.4.2	Procedure .....	35
14.5	Adjusting an infrared image.....	35
14.5.1	General.....	35
14.5.2	Example 1 .....	35
14.5.3	Example 2 .....	36
14.5.4	Procedure .....	36
14.6	Performing a non-uniformity correction (NUC) .....	36
14.6.1	What is a non-uniformity correction?.....	36
14.6.2	When to perform a non-uniformity correction? .....	36
14.6.3	Procedure .....	36
14.7	Changing the temperature range .....	37
14.7.1	General.....	37
14.7.2	Procedure .....	37
14.8	Hiding overlay graphics (programmable button).....	37
14.8.1	General.....	37
14.8.2	Procedure .....	37
14.9	Changing the color palette .....	38
14.9.1	General.....	38
14.9.2	Procedure .....	38
14.10	Deleting an image .....	38
14.10.1	General.....	38
14.10.2	Procedure .....	38
14.11	Deleting all images.....	38
14.11.1	General.....	38
14.11.2	Procedure .....	38
14.12	Creating a PDF report in the camera .....	39
14.12.1	General.....	39
14.12.2	Naming convention.....	39
14.12.3	Procedure .....	39
<b>15</b>	<b>Working with image modes.....</b>	<b>40</b>
15.1	General .....	40
15.2	Image examples .....	40
15.3	Selecting the image mode .....	41
<b>16</b>	<b>Working with measurement tools .....</b>	<b>42</b>
16.1	General .....	42
16.2	Adding/removing measurement tools .....	42
16.3	Working with user presets.....	42
16.3.1	General.....	42
16.3.2	Procedure .....	42
16.4	Resizing or moving a measurement tool.....	43
16.4.1	General.....	43
16.4.2	Procedure .....	43
16.5	Changing object parameters .....	44
16.5.1	General.....	44
16.5.2	Types of parameters .....	44
16.5.3	Recommended values.....	44
16.5.4	Procedure .....	44
16.5.5	Related topics .....	45

## Table of contents

---

16.6	Displaying values in the result table and displaying a graph .....	46
16.6.1	General.....	46
16.6.2	Procedure .....	46
16.7	Creating and setting up a difference calculation .....	46
16.7.1	General.....	46
16.7.2	Procedure .....	46
16.8	Setting a measurement alarm .....	47
16.8.1	General.....	47
16.8.2	Types of alarm .....	47
16.8.3	Alarm signals .....	47
16.8.4	Procedure .....	47
<b>17</b>	<b>Fetching data from external FLIR meters .....</b>	<b>50</b>
17.1	General .....	50
17.2	Supported FLIR meters.....	50
17.3	Technical support for external meters .....	50
17.4	Typical moisture measurement and documentation procedure .....	50
17.4.1	General.....	50
17.4.2	Procedure .....	51
17.5	More information .....	51
<b>18</b>	<b>Working with color alarms and isotherms.....</b>	<b>52</b>
18.1	Color alarms .....	52
18.1.1	General.....	52
18.1.2	Image examples .....	52
18.2	Setting up above, below, and interval alarms.....	53
18.3	Building isotherms .....	54
18.3.1	About the <i>Condensation alarm</i> .....	54
18.3.2	About the <i>Insulation alarm</i> .....	54
18.3.3	Setting up condensation and insulation alarms .....	54
<b>19</b>	<b>Annotating images .....</b>	<b>55</b>
19.1	General .....	55
19.2	Adding a note .....	55
19.2.1	General.....	55
19.2.2	Procedure .....	55
19.3	Adding a table.....	56
19.3.1	General.....	56
19.3.2	Procedure .....	56
19.4	Adding a voice annotation.....	56
19.4.1	General.....	56
19.4.2	Procedure .....	56
19.5	Adding a sketch.....	57
19.5.1	General.....	57
19.5.2	Procedure .....	57
<b>20</b>	<b>Programming the camera (time lapse) .....</b>	<b>58</b>
20.1	General .....	58
20.2	Procedure .....	58
<b>21</b>	<b>Recording video clips .....</b>	<b>59</b>
21.1	General .....	59
21.2	Procedure .....	59
<b>22</b>	<b>Screening alarm .....</b>	<b>60</b>
22.1	General .....	60
22.2	Procedure .....	60
<b>23</b>	<b>Changing settings .....</b>	<b>61</b>
23.1	General .....	61

## Table of contents

---

	23.1.1	<i>Define user presets</i>	61
	23.1.2	<i>Save options</i>	61
	23.1.3	<i>Programmable button</i>	61
	23.1.4	<i>Reset options</i>	61
	23.1.5	<i>Device settings</i>	61
	23.2	Procedure	62
<b>24</b>		<b>Mechanical drawings</b>	<b>63</b>
<b>25</b>		<b>CE Declaration of conformity</b>	<b>73</b>
<b>26</b>		<b>Cleaning the camera</b>	<b>75</b>
	26.1	Camera housing, cables, and other items	75
	26.1.1	Liquids	75
	26.1.2	Equipment	75
	26.1.3	Procedure	75
	26.2	Infrared lens	75
	26.2.1	Liquids	75
	26.2.2	Equipment	75
	26.2.3	Procedure	75
	26.3	Infrared detector	76
	26.3.1	General	76
	26.3.2	Procedure	76
<b>27</b>		<b>Application examples</b>	<b>77</b>
	27.1	Moisture & water damage	77
	27.1.1	General	77
	27.1.2	Figure	77
	27.2	Faulty contact in socket	77
	27.2.1	General	77
	27.2.2	Figure	77
	27.3	Oxidized socket	78
	27.3.1	General	78
	27.3.2	Figure	78
	27.4	Insulation deficiencies	79
	27.4.1	General	79
	27.4.2	Figure	79
	27.5	Draft	79
	27.5.1	General	79
	27.5.2	Figure	79
<b>28</b>		<b>Thermographic measurement techniques</b>	<b>81</b>
	28.1	Introduction	81
	28.2	Emissivity	81
	28.2.1	Finding the emissivity of a sample	81
	28.3	Reflected apparent temperature	85
	28.4	Distance	85
	28.5	Relative humidity	85
	28.6	Other parameters	85
<b>29</b>		<b>About FLIR Systems</b>	<b>86</b>
	29.1	More than just an infrared camera	87
	29.2	Sharing our knowledge	87
	29.3	Supporting our customers	88





## 1.1 Legal disclaimer

For warranty terms, please refer to <https://www.flir.com/warranty>.

## 1.2 Usage statistics

FLIR Systems reserves the right to gather anonymous usage statistics to help maintain and improve the quality of our software and services.

## 1.3 U.S. Government Regulations

This product may be subject to U.S. Export Regulations. Please send any inquiries to [exportquestions@flir.com](mailto:exportquestions@flir.com).

## 1.4 Copyright

© 2019, FLIR Systems, Inc. All rights reserved worldwide. No parts of the software including source code may be reproduced, transmitted, transcribed or translated into any language or computer language in any form or by any means, electronic, magnetic, optical, manual or otherwise, without the prior written permission of FLIR Systems.

The documentation must not, in whole or part, be copied, photocopied, reproduced, translated or transmitted to any electronic medium or machine readable form without prior consent, in writing, from FLIR Systems.

Names and marks appearing on the products herein are either registered trademarks or trademarks of FLIR Systems and/or its subsidiaries. All other trademarks, trade names or company names referenced herein are used for identification only and are the property of their respective owners.

## 1.5 Quality assurance

The Quality Management System under which these products are developed and manufactured has been certified in accordance with the ISO 9001 standard.

FLIR Systems is committed to a policy of continuous development; therefore we reserve the right to make changes and improvements on any of the products without prior notice.

## 1.6 Patents







This product is protected by patents, design patents, patents pending, or design patents pending. Please refer to the FLIR Systems' patent registry: <https://www.flir.com/patentnotices>.











## 1.7 EULA Terms

Qt4 Core and Qt4 GUI, Copyright ©2013 Nokia Corporation and FLIR Systems AB. This Qt library is a free software; you can redistribute it and/or modify it under the terms of the GNU Lesser General Public License as published by the Free Software Foundation; either version 2.1 of the License, or (at your option) any later version. This library is distributed in the hope that it will be useful, but WITHOUT ANY WARRANTY; without even the implied warranty of MERCHANTABILITY or FITNESS FOR A PARTICULAR PURPOSE. See the GNU Lesser General Public License, <http://www.gnu.org/licenses/lgpl-2.1.html>. The source code for the libraries Qt4 Core and Qt4 GUI may be requested from FLIR Systems AB.











## 1.8 EULA Terms







- You have acquired a device ("INFRARED CAMERA") that includes software licensed by FLIR Systems AB from Microsoft Licensing, GP or its affiliates ("MS"). Those installed software products of MS origin, as well as associated media, printed materials, and "online" or electronic documentation ("SOFTWARE") are protected by international intellectual property laws and treaties. The SOFTWARE is licensed, not sold. All rights reserved.
- IF YOU DO NOT AGREE TO THIS END USER LICENSE AGREEMENT ("EULA"), DO NOT USE THE DEVICE OR COPY THE SOFTWARE. INSTEAD, PROMPTLY CONTACT FLIR Systems AB FOR INSTRUCTIONS ON RETURN OF THE UNUSED DEVICE(S) FOR A REFUND. **ANY USE OF THE SOFTWARE, INCLUDING BUT NOT LIMITED TO USE ON THE DEVICE, WILL CONSTITUTE YOUR AGREEMENT TO THIS EULA (OR RATIFICATION OF ANY PREVIOUS CONSENT).**
- **GRANT OF SOFTWARE LICENSE.** This EULA grants you the following license:
  - You may use the SOFTWARE only on the DEVICE.
  - **NOT FAULT TOLERANT.** THE SOFTWARE IS NOT FAULT TOLERANT. FLIR Systems AB HAS INDEPENDENTLY DETERMINED HOW TO USE THE SOFTWARE IN THE DEVICE, AND MS HAS RELIED UPON FLIR Systems AB TO CONDUCT SUFFICIENT TESTING TO DETERMINE THAT THE SOFTWARE IS SUITABLE FOR SUCH USE.
  - **NO WARRANTIES FOR THE SOFTWARE.** THE SOFTWARE is provided "AS IS" and with all faults. THE ENTIRE RISK AS TO SATISFACTORY QUALITY, PERFORMANCE, ACCURACY, AND EFFORT (INCLUDING LACK OF NEGLIGENCE) IS WITH YOU. ALSO, THERE IS NO WARRANTY AGAINST INTERFERENCE WITH YOUR ENJOYMENT OF THE SOFTWARE OR AGAINST INFRINGEMENT. **IF YOU HAVE RECEIVED ANY WARRANTIES REGARDING THE DEVICE OR THE SOFTWARE, THOSE WARRANTIES DO NOT ORIGINATE FROM, AND ARE NOT BINDING ON, MS.**
  - No Liability for Certain Damages. **EXCEPT AS PROHIBITED BY LAW, MS SHALL HAVE NO LIABILITY FOR ANY INDIRECT, SPECIAL, CONSEQUENTIAL OR INCIDENTAL DAMAGES ARISING FROM OR IN CONNECTION WITH THE USE OR PERFORMANCE OF THE SOFTWARE. THIS LIMITATION SHALL APPLY EVEN IF ANY REMEDY FAILS OF ITS ESSENTIAL PURPOSE. IN NO EVENT SHALL MS BE LIABLE FOR ANY AMOUNT IN EXCESS OF U.S. TWO HUNDRED FIFTY DOLLARS (U.S.\$250.00).**
  - **Limitations on Reverse Engineering, Decompilation, and Disassembly.** You may not reverse engineer, decompile, or disassemble the SOFTWARE, except and only to the extent that such activity is expressly permitted by applicable law notwithstanding this limitation.
  - **SOFTWARE TRANSFER ALLOWED BUT WITH RESTRICTIONS.** You may permanently transfer rights under this EULA only as part of a permanent sale or transfer of the Device, and only if the recipient agrees to this EULA. If the SOFTWARE is an upgrade, any transfer must also include all prior versions of the SOFTWARE.
  - **EXPORT RESTRICTIONS.** You acknowledge that SOFTWARE is subject to U.S. export jurisdiction. You agree to comply with all applicable international and national laws that apply to the SOFTWARE, including the U.S. Export Administration Regulations, as well as end-user, end-use and destination restrictions issued by U.S. and other governments. For additional information see <http://www.microsoft.com/exporting/>.

 <b>WARNING</b>
<p><b>Applicability:</b> Class B digital devices.</p> <p>This equipment has been tested and found to comply with the limits for a Class B digital device, pursuant to Part 15 of the FCC Rules. These limits are designed to provide reasonable protection against harmful interference in a residential installation. This equipment generates, uses and can radiate radio frequency energy and, if not installed and used in accordance with the instructions, may cause harmful interference to radio communications. However, there is no guarantee that interference will not occur in a particular installation. If this equipment does cause harmful interference to radio or television reception, which can be determined by turning the equipment off and on, the user is encouraged to try to correct the interference by one or more of the following measures:</p> <ul style="list-style-type: none"> <li>• Reorient or relocate the receiving antenna.</li> <li>• Increase the separation between the equipment and receiver.</li> <li>• Connect the equipment into an outlet on a circuit different from that to which the receiver is connected.</li> <li>• Consult the dealer or an experienced radio/TV technician for help.</li> </ul>
 <b>WARNING</b>
<p><b>Applicability:</b> Digital devices subject to 15.19/RSS-247.</p> <p><b>NOTICE:</b> This device complies with Part 15 of the FCC Rules and with RSS-247 of Industry Canada. Operation is subject to the following two conditions:</p> <ol style="list-style-type: none"> <li>1. this device may not cause harmful interference, and</li> <li>2. this device must accept any interference received, including interference that may cause undesired operation.</li> </ol>
 <b>WARNING</b>
<p><b>Applicability:</b> Digital devices subject to 15.21.</p> <p><b>NOTICE:</b> Changes or modifications made to this equipment not expressly approved by FLIR Systems may void the FCC authorization to operate this equipment.</p>
 <b>WARNING</b>
<p><b>Applicability:</b> Devices subject to RSS-102/47CFR2.1093.</p> <p>This device has been tested and meets the FCC/ISED RF exposure guidelines, or the device is exempted from SAR because of the low output power. Nevertheless, the device should be used in such a manner that the potential for human contact during normal operation is minimized.</p>
 <b>WARNING</b>
<p><b>Applicability:</b> Cameras with one or more laser pointers.</p> <p>Do not look directly into the laser beam. The laser beam can cause eye irritation.</p>
 <b>WARNING</b>
<p><b>Applicability:</b> Cameras with one or more batteries.</p> <p>Do not disassemble or do a modification to the battery. The battery contains safety and protection devices which, if damage occurs, can cause the battery to become hot, or cause an explosion or an ignition.</p>
 <b>WARNING</b>
<p><b>Applicability:</b> Cameras with one or more batteries.</p> <p>If there is a leak from the battery and you get the fluid in your eyes, do not rub your eyes. Flush well with water and immediately get medical care. The battery fluid can cause injury to your eyes if you do not do this.</p>

 <b>WARNING</b>
<b>Applicability:</b> Cameras with one or more batteries. Do not continue to charge the battery if it does not become charged in the specified charging time. If you continue to charge the battery, it can become hot and cause an explosion or ignition. Injury to persons can occur.
 <b>WARNING</b>
<b>Applicability:</b> Cameras with one or more batteries. Only use the correct equipment to remove the electrical power from the battery. If you do not use the correct equipment, you can decrease the performance or the life cycle of the battery. If you do not use the correct equipment, an incorrect flow of current to the battery can occur. This can cause the battery to become hot, or cause an explosion. Injury to persons can occur.
 <b>WARNING</b>
Make sure that you read all applicable MSDS (Material Safety Data Sheets) and warning labels on containers before you use a liquid. The liquids can be dangerous. Injury to persons can occur.
 <b>CAUTION</b>
Do not point the infrared camera (with or without the lens cover) at strong energy sources, for example, devices that cause laser radiation, or the sun. This can have an unwanted effect on the accuracy of the camera. It can also cause damage to the detector in the camera.
 <b>CAUTION</b>
Do not use the camera in temperatures more than +50°C (+122°F), unless other information is specified in the user documentation or technical data. High temperatures can cause damage to the camera.
 <b>CAUTION</b>
<b>Applicability:</b> Cameras with one or more laser pointers. To prevent damage, put the protective cap on the laser pointer when you do not operate the laser pointer. Damage to the laser pointer can occur if you do not do this.
 <b>CAUTION</b>
<b>Applicability:</b> Cameras with one or more batteries. Do not attach the batteries directly to a car's cigarette lighter socket, unless FLIR Systems supplies a specific adapter to connect the batteries to a cigarette lighter socket. Damage to the batteries can occur.
 <b>CAUTION</b>
<b>Applicability:</b> Cameras with one or more batteries. Do not connect the positive terminal and the negative terminal of the battery to each other with a metal object (such as wire). Damage to the batteries can occur.
 <b>CAUTION</b>
<b>Applicability:</b> Cameras with one or more batteries. Do not get water or salt water on the battery, or permit the battery to become wet. Damage to the batteries can occur.
 <b>CAUTION</b>
<b>Applicability:</b> Cameras with one or more batteries. Do not make holes in the battery with objects. Damage to the battery can occur.

## Safety information

 <b>CAUTION</b>
<b>Applicability:</b> Cameras with one or more batteries. Do not hit the battery with a hammer. Damage to the battery can occur.
 <b>CAUTION</b>
<b>Applicability:</b> Cameras with one or more batteries. Do not put your foot on the battery, hit it or cause shocks to it. Damage to the battery can occur.
 <b>CAUTION</b>
<b>Applicability:</b> Cameras with one or more batteries. Do not put the batteries in or near a fire, or into direct sunlight. When the battery becomes hot, the built-in safety equipment becomes energized and can stop the battery charging procedure. If the battery becomes hot, damage can occur to the safety equipment and this can cause more heat, damage or ignition of the battery.
 <b>CAUTION</b>
<b>Applicability:</b> Cameras with one or more batteries. Do not put the battery on a fire or increase the temperature of the battery with heat. Damage to the battery and injury to persons can occur.
 <b>CAUTION</b>
<b>Applicability:</b> Cameras with one or more batteries. Do not put the battery on or near fires, stoves, or other high-temperature locations. Damage to the battery and injury to persons can occur.
 <b>CAUTION</b>
<b>Applicability:</b> Cameras with one or more batteries. Do not solder directly onto the battery. Damage to the battery can occur.
 <b>CAUTION</b>
<b>Applicability:</b> Cameras with one or more batteries. Do not use the battery if, when you use, charge, or put the battery in storage, there is an unusual smell from the battery, the battery feels hot, changes color, changes shape, or is in an unusual condition. Speak with your sales office if one or more of these problems occurs. Damage to the battery and injury to persons can occur.
 <b>CAUTION</b>
<b>Applicability:</b> Cameras with one or more batteries. Only use a specified battery charger when you charge the battery. Damage to the battery can occur if you do not do this.
 <b>CAUTION</b>
<b>Applicability:</b> Cameras with one or more batteries. Only use a specified battery for the camera. Damage to the camera and the battery can occur if you do not do this.
 <b>CAUTION</b>
<b>Applicability:</b> Cameras with one or more batteries. The temperature range through which you can charge the battery is 0°C to +45°C (+32°F to +113°F). If you charge the battery at temperatures out of this range, it can cause the battery to become hot or to break. It can also decrease the performance or the life cycle of the battery.

 <b>CAUTION</b>	
<p><b>Applicability:</b> Cameras with one or more batteries.</p> <p>The temperature range through which you can remove the electrical power from the battery is -15°C to +50°C (+5°F to +122°F), unless other information is specified in the user documentation or technical data. If you operate the battery out of this temperature range, it can decrease the performance or the life cycle of the battery.</p>	
 <b>CAUTION</b>	
<p><b>Applicability:</b> Cameras with one or more batteries.</p> <p>When the battery is worn, apply insulation to the terminals with adhesive tape or equivalent materials before you discard it. Damage to the battery and injury to persons can occur if you do not do this.</p>	
 <b>CAUTION</b>	
<p><b>Applicability:</b> Cameras with one or more batteries.</p> <p>Remove any water or moisture on the battery before you install it. Damage to the battery can occur if you do not do this.</p>	
 <b>CAUTION</b>	
<p>Do not apply solvents or equivalent liquids to the camera, the cables, or other items. Damage to the battery and injury to persons can occur.</p>	
 <b>CAUTION</b>	
<p>Be careful when you clean the infrared lens. The lens has an anti-reflective coating which is easily damaged. Damage to the infrared lens can occur.</p>	
 <b>CAUTION</b>	
<p>Do not use too much force to clean the infrared lens. This can cause damage to the anti-reflective coating.</p>	
<p><b>Note</b> The encapsulation rating is only applicable when all the openings on the camera are sealed with their correct covers, hatches, or caps. This includes the compartments for data storage, batteries, and connectors.</p>	
 <b>CAUTION</b>	
<p><b>Applicability:</b> Cameras with a viewfinder.</p> <p>Make sure that the beams from the intensive energy sources do not go into the viewfinder. The beams can cause damage to the camera. This includes the devices that emit laser radiation, or the sun.</p>	

## 3.1 Calibration

We recommend that you send in the camera for calibration once a year. Contact your local sales office for instructions on where to send the camera.

## 3.2 Accuracy

For very accurate results, we recommend that you wait 5 minutes after you have started the camera before measuring a temperature.

## 3.3 Disposal of electronic waste

Electrical and electronic equipment (EEE) contains materials, components and substances that may be hazardous and present a risk to human health and the environment when waste electrical and electronic equipment (WEEE) is not handled correctly.

Equipment marked with the below crossed-out wheeled bin is electrical and electronic equipment. The crossed-out wheeled bin symbol indicates that waste electrical and electronic equipment should not be discarded together with unseparated household waste, but must be collected separately.

For this purpose all local authorities have established collection schemes under which residents can dispose waste electrical and electronic equipment at a recycling centre or other collection points, or WEEE will be collected directly from households. More detailed information is available from the technical administration of the relevant local authority.



## 3.4 Training

To read about infrared training, visit:

- <http://www.infraredtraining.com>
- <http://www.irtraining.com>
- <http://www.irtraining.eu>

## 3.5 Documentation updates

Our manuals are updated several times per year, and we also issue product-critical notifications of changes on a regular basis.

To access the latest manuals, translations of manuals, and notifications, go to the Download tab at:

<http://support.flir.com>

It only takes a few minutes to register online. In the download area you will also find the latest releases of manuals for our other products, as well as manuals for our historical and obsolete products.

### **3.6 Important note about this manual**

FLIR Systems issues generic manuals that cover several cameras within a model line.

This means that this manual may contain descriptions and explanations that do not apply to your particular camera model.

### **3.7 Note about authoritative versions**

The authoritative version of this publication is English. In the event of divergences due to translation errors, the English text has precedence.

Any late changes are first implemented in English.

## 4.1 General

For customer help, visit:

<http://support.flir.com>

## 4.2 Submitting a question

To submit a question to the customer help team, you must be a registered user. It only takes a few minutes to register online. If you only want to search the knowledgebase for existing questions and answers, you do not need to be a registered user.

When you want to submit a question, make sure that you have the following information to hand:

- The camera model
- The camera serial number
- The communication protocol, or method, between the camera and your device (for example, SD card reader, HDMI, Ethernet, USB, or FireWire)
- Device type (PC/Mac/iPhone/iPad/Android device, etc.)
- Version of any programs from FLIR Systems
- Full name, publication number, and revision number of the manual

## 4.3 Downloads

On the customer help site you can also download the following, when applicable for the product:

- Firmware updates for your infrared camera.
- Program updates for your PC/Mac software.
- Freeware and evaluation versions of PC/Mac software.
- User documentation for current, obsolete, and historical products.
- Mechanical drawings (in \*.dxf and \*.pdf format).
- Cad data models (in \*.stp format).
- Application stories.
- Technical datasheets.



## 5.1 Procedure

Follow this procedure:

1. Put a battery into the battery compartment.
2. Charge the battery for 4 hours before starting the camera for the first time.
3. Insert a memory card into the card slot.
4. Push the On/off button  to turn on the camera.
5. Aim the camera toward the object of interest.
6. Adjust the focus.

**Note** It is very important to adjust the focus correctly. Incorrect focus adjustment affects how the image modes work. It also affects the temperature measurement.

7. Push the Autofocus/save button fully down to save an image.
8. Go to <http://support.flir.com/tools> and download FLIR Tools.
9. Install FLIR Tools on your computer.
10. Start FLIR Tools.
11. Connect the camera to the computer using a USB cable.
12. Import the images into FLIR Tools.
13. Select one or more images.
14. Click *Generate report*.
15. Click *Export* to export the report as a PDF file.
16. Send the PDF report to your client.

Product name	Part number
Battery charger, incl. power supply with multi plugs T6xx	T198126
Bluetooth Headset	T197771ACC
Calibration including General maintenance T6xx series	T199838
Cigarette lighter adapter kit, 12 VDC, 1.2 m/3.9 ft.	T198509
Close-up IR lens, 1.5x (25 µm) with case	T198066
Close-up IR lens, 2.9x (50 µm) with case	T198059
Close-up IR lens, 5.8x (100 µm) with case	T198060
FLIR Reporter Professional (license only)	T198586
FLIR ResearchIR 3 (license only)	T198578
FLIR ResearchIR 3 Max (license only)	T198574
FLIR ResearchIR Max + HSDR 4	T198697
FLIR ResearchIR Max 4	T198696
FLIR ResearchIR Standard 4	T198731
FLIR Tools	T198584
FLIR Tools+ (license only)	T198583
Hard transport case for T6xx series	T198625ACC
HDMI type C to DVI cable 1.5 m	T910930ACC
HDMI type C to HDMI type A cable 1.5 m	T910891ACC
High temp option +300°C to 2000°C (+572°F to 3632°F) for FLIR A6xxsc and T6xx	T197896
IR lens, f=13.1 mm (45°) with case	T197915
IR lens, f=24.6 mm (25°) with case	T197922
IR lens, f=41.3 mm (15°) with case	T197914
IR lens, f=6.5 mm (80°) with case	T198065
IR lens, f=88.9 mm (7°) with case and support for T6xx	T198166
IR Window 2 in	19250-100
IR Window 3 in.	19251-100
IR Window 4 in.	19252-100
Large eyecup	T198497
Li-Ion Battery pack 3.7V 29Wh	T198506
Memory card SDHC 4 GB	T911230ACC
Neck strap	T198499
One year extended warranty for T6xx series	T199836
Pouch for FLIR T6xx and T4xx series	T198495
Power supply, incl. multi plugs	T910814
SS IR Window 2 in.	19250-200
SS IR Window 3 in.	19251-200
SS IR Window 4 in.	19252-200
Tool belt	T911093
Tripod Adapter	T198498
USB cable Std A <-> Mini-B	1910423

**Note** FLIR Systems reserves the right to discontinue models, parts or accessories, and other items, or to change specifications at any time without prior notice.

## 7.1 General

To prevent strain-related injuries, it is important that you hold the camera ergonomically correct. This section gives advice and examples on how to hold the camera.

**Note** Please note the following:

- Always tilt the touch-screen LCD to suit your work position.
- When you hold the camera, make sure that you support the optics housing with your left hand too. This decreases the strain on your right hand.

## 7.2 Figure

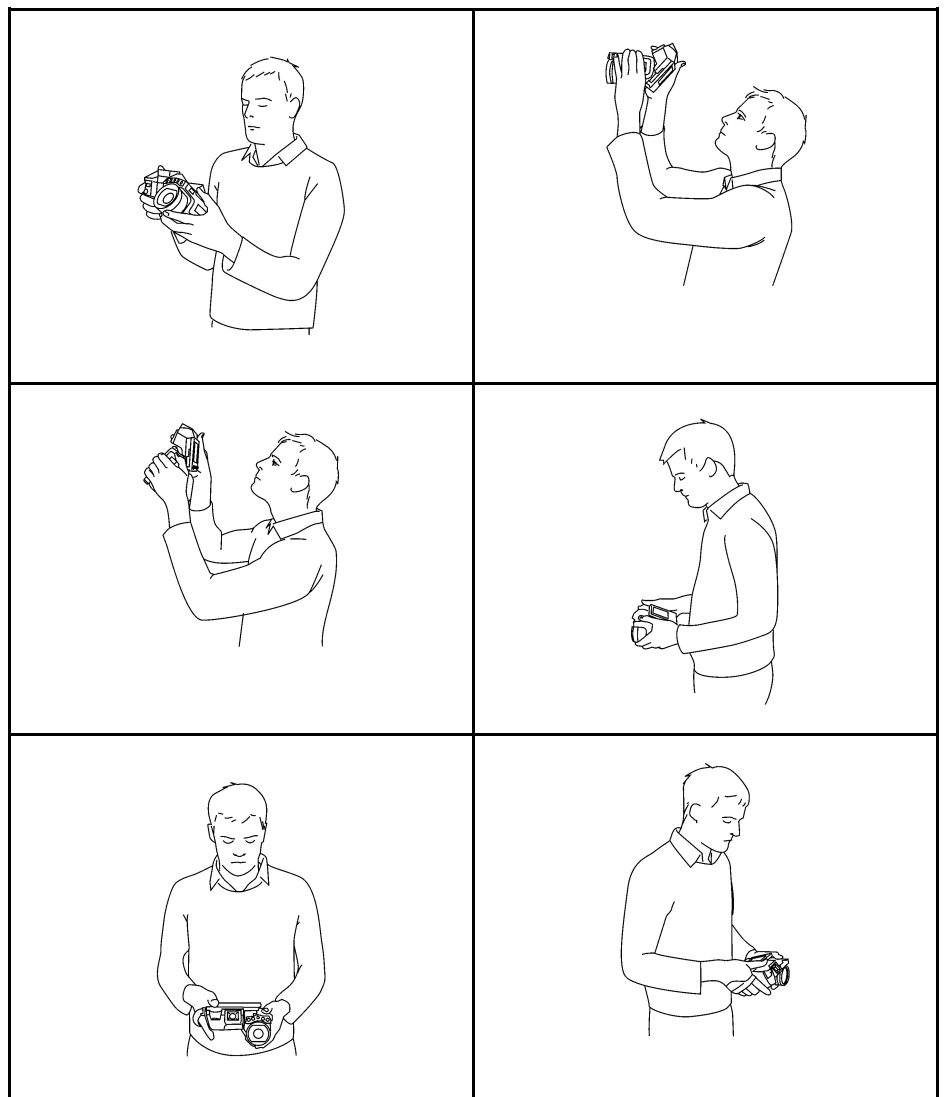

## 8.1 View from the right

### 8.1.1 Figure

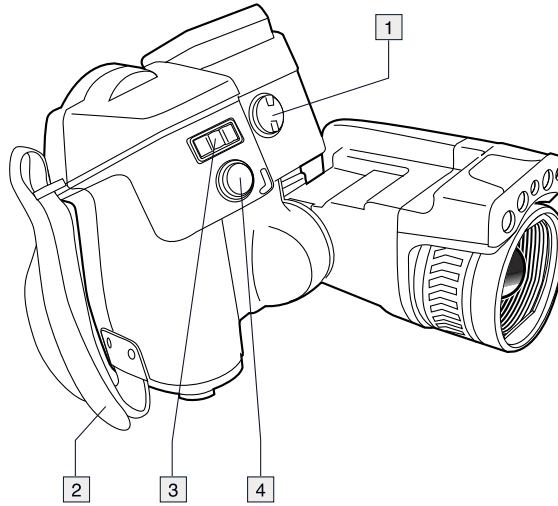

### 8.1.2 Explanation

1. Knob to change the dioptic correction for the viewfinder.

**Note** This item is dependent on the camera model.

2. Hand strap.
3. Digital zoom button.
4. Autofocus button (push half-way down)/Save button (push fully down).

---

## 8.2 View from the left

### 8.2.1 Figure

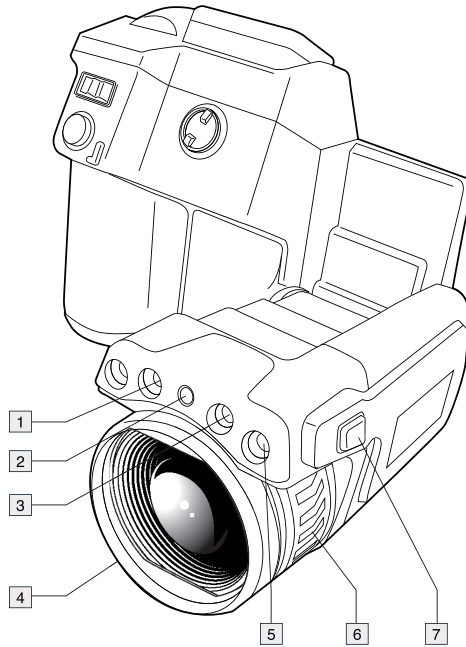

### 8.2.2 Explanation

1. Camera lamp.
2. Laser pointer.

**Note** The laser pointer may not be enabled in all markets.

3. Camera lamp.
4. Infrared lens.
5. Digital camera.
6. Focusing ring.
7. Button to operate the laser pointer.

## 8.3 View from the rear

### 8.3.1 Figure

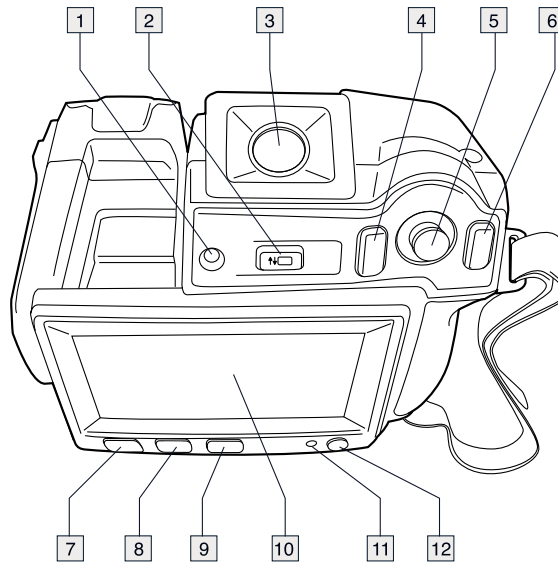

### 8.3.2 Explanation

1. Sensor that adjusts the touch-screen LCD intensity automatically.
2. Button to switch between touch-screen LCD mode and viewfinder mode.

**Note** This item is dependent on the camera model.

3. Viewfinder.

**Note** This item is dependent on the camera model.

4. Programmable button.
5. Joystick with push-button functionality.
6. Back button.
7. Camera lamp button.
8. Button to switch between automatic and manual image adjustment mode.
9. Image archive button.
10. Touch-screen LCD.
11. Power indicator.
12. On/off button.

## 8.4 View from the bottom

### 8.4.1 Figure

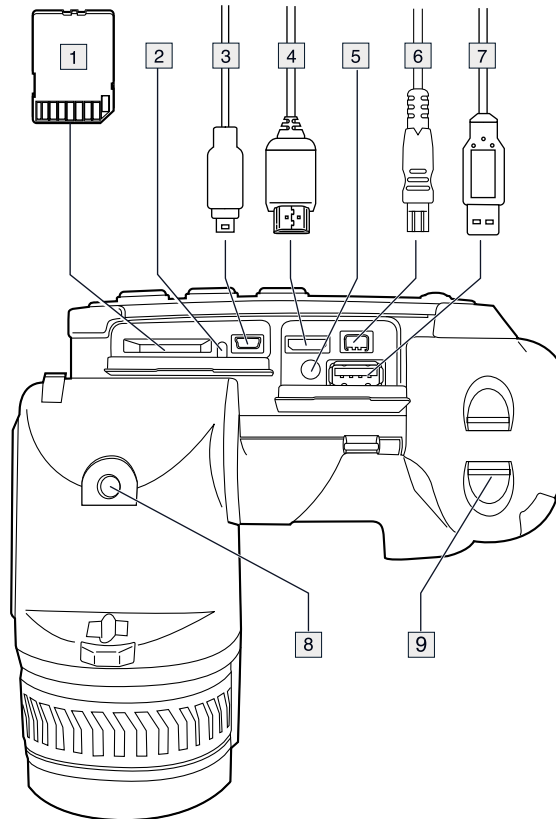

### 8.4.2 Explanation

1. Memory card.
2. Indicator showing that the memory card is busy.

#### Note

- Do not eject the memory card when this LED is flashing.
- Do not connect the camera to a computer when this LED is flashing.

3. USB Mini-B cable (to connect the camera to a computer).
4. HDMI cable (for digital video output).
5. Battery condition LED indicator.
6. Power cable (to power the camera and charge the battery).
7. USB-A cable (to connect an external USB device to the camera).
8. Tripod mount. Requires an adapter (included).
9. Latch to release the battery.



## 8.5 Battery condition LED indicator

### 8.5.1 Figure

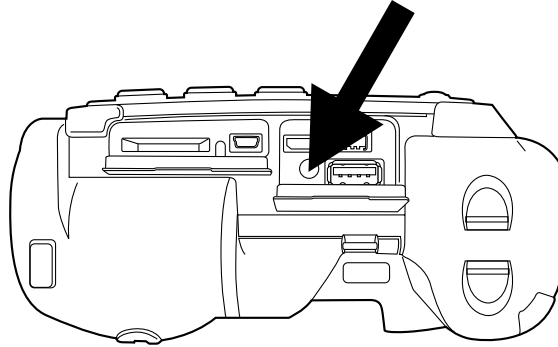

### 8.5.2 Explanation

Type of signal	Explanation
The green LED flashes twice per second.	The battery is being charged.
The green LED glows continuously.	The battery is fully charged.

## 8.6 Power LED indicator

### 8.6.1 Figure

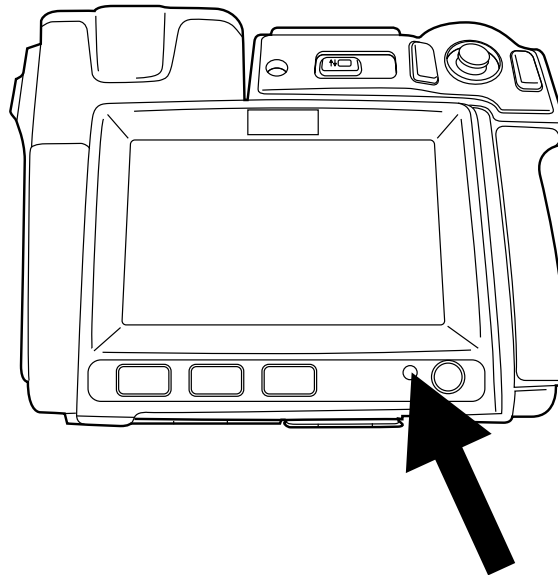

### 8.6.2 Explanation

Type of signal	Explanation
The LED is off.	The camera is off.
The LED is blue.	The camera is on.

## 8.7 Laser pointer

### 8.7.1 Figure

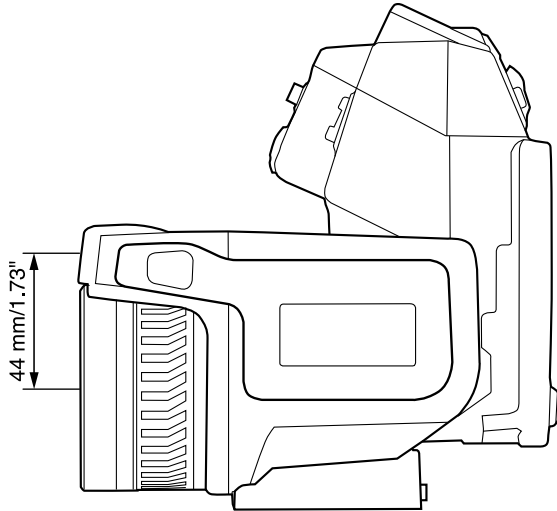



**Figure 8.1** This figure shows the difference in position between the laser pointer and the optical center of the infrared lens.



#### WARNING

Do not look directly into the laser beam. The laser beam can cause eye irritation.

**Note** The symbol  is displayed on the screen when the laser pointer is on.

**Note** The laser pointer is enabled by a setting. Select  (*Settings*) > *Device settings* > *Set up camera* > *Lamp & laser* > *Enable lamp & laser*.

**Note** The laser pointer may not be enabled in all markets.

### 8.7.2 Laser warning label

A laser warning label with the following information is attached to the camera:

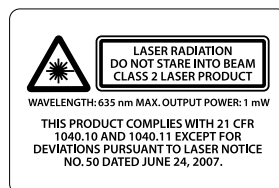

### 8.7.3 Laser rules and regulations

Wavelength: 635 nm. Maximum output power: 1 mW.

This product complies with 21 CFR 1040.10 and 1040.11 except for deviations pursuant to Laser Notice No. 50, dated June 24, 2007.

### 9.1 Figure

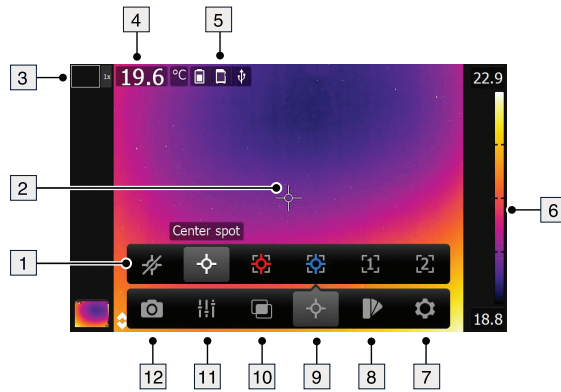

### 9.2 Explanation

1. Measurement toolbar.
2. Measurement tool (e.g., spotmeter).
3. Zoom factor.
4. Result table.
5. Status icons.
6. Temperature scale.
7. Settings toolbar button.
8. Color toolbar button.
9. Measurement toolbar button.
10. Image mode toolbar button.
11. Measurement parameters toolbar button.
12. Recording mode toolbar button.

## 10.1 Figure

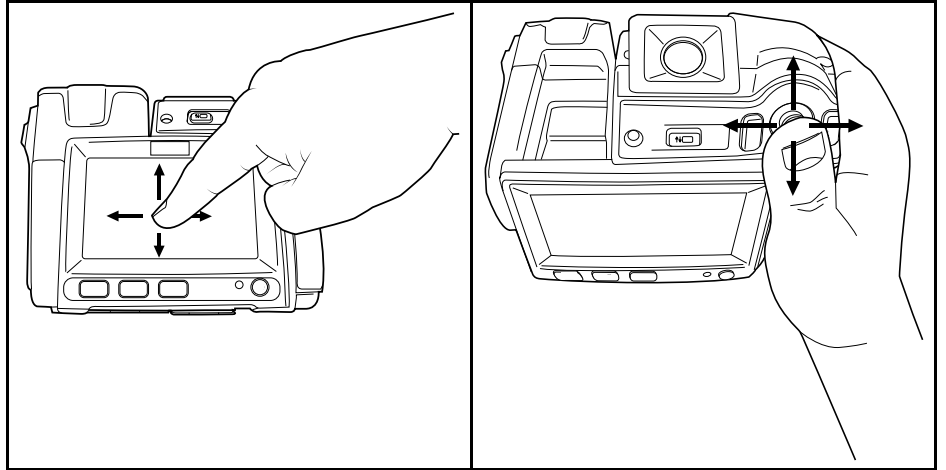

## 10.2 Explanation

The figure above shows the two ways to navigate the menu system in the camera:

- Using the index finger or a stylus pen specially designed for capacitive touch usage to navigate the menu system (left).
- Using the joystick to navigate the menu system (right).

You can also use a combination of the two.

In this manual it is assumed that the joystick is used, but most tasks can also be carried out using the index finger or a stylus pen.

## 11.1 General

Before you can use a Bluetooth device with the camera, you need to pair the devices.

## 11.2 Procedure

Follow this procedure:

1. Push the joystick to display the menu system.
2. Use the joystick to go to  (*Settings*).
3. Push the joystick to display the *Settings* menu.
4. Select *Device settings* and push the joystick.
5. Select *Bluetooth including METERLiNK* and push the joystick.
6. If the *Bluetooth* check box is unchecked, push the joystick to activate Bluetooth.  
**Note** You also need to activate Bluetooth connectivity on the external device.
7. Select *Scan for Bluetooth devices* and push the joystick.
8. Wait until a list of available devices is displayed. This will take about 15 seconds.
9. When a Bluetooth device is found, select the device to add it, and begin the pairing procedure. The device is then ready to be used.

### Note

- Only METERLiNK devices and Bluetooth-enabled headsets will appear in the list of available devices.
- You can add several devices.
- You can remove a device by selecting the device and then selecting *Unpair device*.
- After adding a METERLiNK device, such as the FLIR MR77 or FLIR DM93, the result from the meter will be visible in the result table and stored with the images. For more information, see section 17 *Fetching data from external FLIR meters*, page 50.
- After adding a Bluetooth-enabled headset, it is ready to be used for adding voice annotations.

## 12.1 General

Depending on your camera configuration, you can connect the camera to a wireless local area network (WLAN) using Wi-Fi, or let the camera provide Wi-Fi access to another device.

You can connect the camera in two different ways:

- *Most common use:* Setting up a peer-to-peer connection (also called an *ad hoc* or *P2P* connection). This method is primarily used with other devices, e.g., an iPhone or iPad.
- *Less common use:* Connecting the camera to a WLAN.

## 12.2 Setting up a peer-to-peer connection (most common use)

Follow this procedure:

1. Push the joystick to display the menu system.
2. Use the joystick to go to  (*Settings*).
3. Push the joystick to display the *Settings* menu.
4. Select *Device settings* and push the joystick.
5. Select *Wi-Fi* and push the joystick.
6. Select *Share* and push the joystick.
7. (Optional step.) To display and change the parameters, select *Settings* and push the joystick.
  - To change the channel (the channel that the camera is broadcasting on), select *Channel* and push the joystick.
  - To activate WEP (encryption algorithm), select *WEP* and push the joystick. This will check the *WEP* check box.
  - To change the WEP password, select *Password* and push the joystick.

**Note** These parameters are set for your camera's network. They will be used by the external device to connect that device to the network.

## 12.3 Connecting the camera to a wireless local area network (less common use)

Follow this procedure:

1. Push the joystick to display the menu system.
2. Use the joystick to go to  (*Settings*).
3. Push the joystick to display the *Settings* menu.
4. Select *Device settings* and push the joystick.
5. Select *Wi-Fi* and push the joystick.
6. Select *Connect to network* and push the joystick.
7. To display a list of the available networks, select *Networks* and push the joystick.
8. Select one of the available networks.

Password-protected networks are indicated with a padlock icon, and for these you will need to enter a password.

**Note** Some networks do not broadcast their existence. To connect to such a network, select *Settings* from the *Networks* list and push the joystick. Then select *Add network...* and set all parameters manually according to that network.

## 13.1 Charging the battery

**Note** You must charge the battery for 4 hours before you start using the camera for the first time.

### 13.1.1 Using the power supply to charge the battery

#### 13.1.1.1 Procedure

Follow this procedure:

1. Connect the power supply cable plug to the power connector on the camera.
2. Connect the power supply mains-electricity plug to a mains socket.
3. Disconnect the power supply cable plug when the green light of the battery condition LED indicator is continuous.

### 13.1.2 Using the stand-alone battery charger to charge the battery

#### 13.1.2.1 Explanation

Type of signal	Explanation
The blue LED flashes.	The battery is being charged.
The blue LED glows continuous.	The battery is fully charged.

#### 13.1.2.2 Procedure

Follow this procedure:

1. Put the battery in the battery charger.
2. Connect the power supply cable plug to the connector on the battery charger.
3. Connect the power supply mains-electricity plug to a mains socket.
4. Disconnect the power supply cable plug when the blue LED on the battery charger is continuous.

## 13.2 Turning on the camera

### 13.2.1 Procedure

Follow this procedure:

1. To turn on the camera, push and release the  button.

## 13.3 Turning off the camera

### 13.3.1 Procedure

Follow this procedure:

1. To turn off the camera, push and hold the  button for more than 0.2 second.

---

## 13.4 Adjusting the viewfinder's dioptic correction

### 13.4.1 Figure

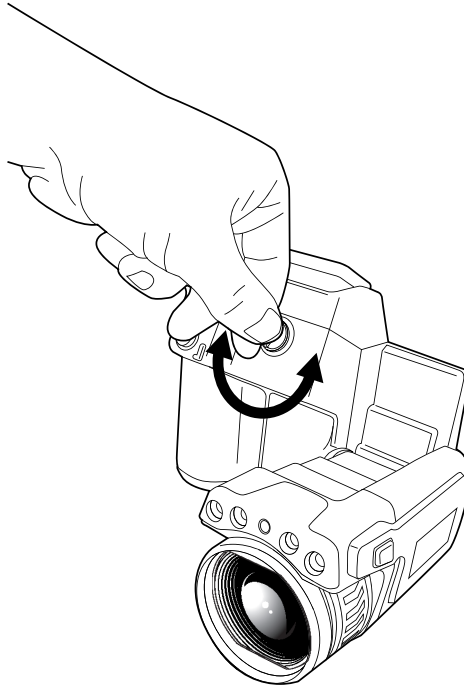
**CAUTION**

**Applicability:** Cameras with a viewfinder.

Make sure that the beams from the intensive energy sources do not go into the viewfinder. The beams can cause damage to the camera. This includes the devices that emit laser radiation, or the sun.

**Note** This item is dependent on the camera model.

### 13.4.2 Procedure

Follow this procedure:

1. To adjust the viewfinder's dioptic correction, look at the displayed text or graphics on the screen, and rotate the adjustment knob clockwise or counter-clockwise for best sharpness.

**Note**

- Maximum dioptic correction: +2.
- Minimum dioptic correction: -2.



---

## 13.5 Adjusting the angle of the lens

13.5.1 Figure

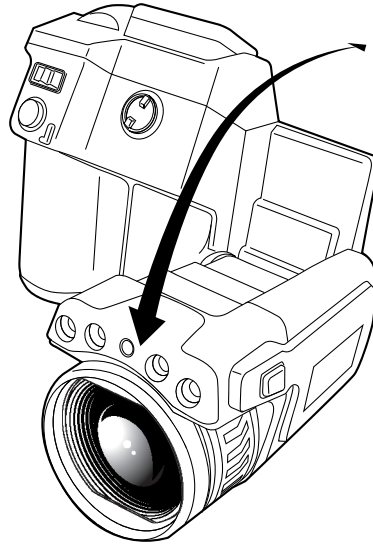

## 13.6 Adjusting the infrared camera focus manually

13.6.1 Figure

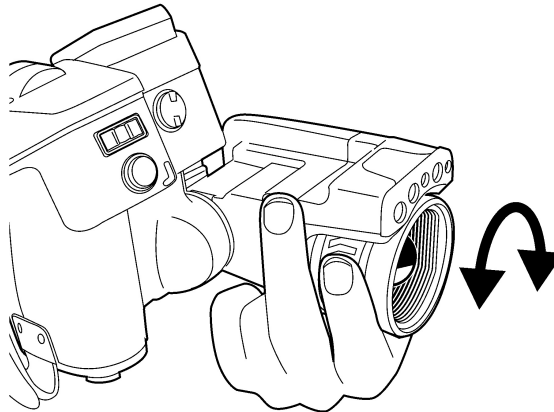

### 13.6.2 Procedure

Follow this procedure:

1. Do one of the following:
  - For far focus, rotate the focus ring clockwise (looking at the touch-screen LCD side).
  - For near focus, rotate the focus ring counter-clockwise (looking at the touch-screen LCD side).

**Note**

- Do not touch the lens surface when you adjust the infrared camera focus manually. If this happens, clean the lens according to the instructions in 26.2 *Infrared lens*, page 75.
- The focus ring can be rotated infinitely, but only a certain amount of rotation is needed when focusing.

## 13.7 Autofocusing the infrared camera

### 13.7.1 Figure

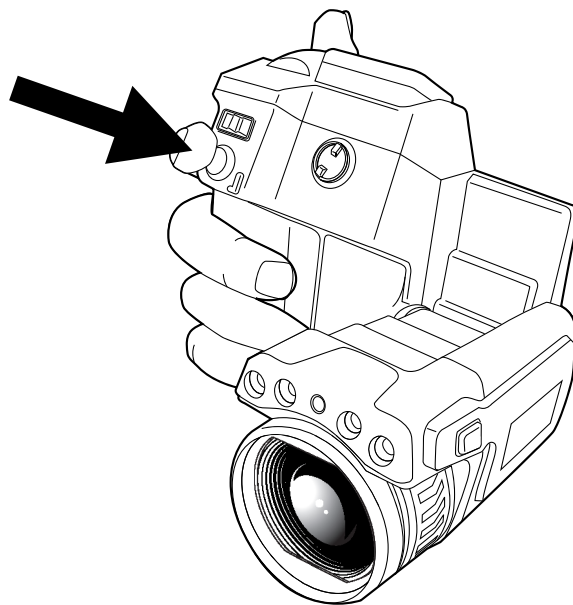

### 13.7.2 Procedure

Follow this procedure:

1. To autofocus the camera when continuous autofocus is disabled, push the Autofocus/Save button half-way down.

## 13.8 Continuous autofocus

### 13.8.1 General

The camera can be set up to perform continuous autofocusing.

**Note**

- Continuous autofocus is not supported by all camera models.
- In this mode, the digital camera is used, which means that continuous autofocus will not work in darkness.
- When continuous autofocus is enabled, it is not possible to manually adjust the focus by rotating the focus ring.

### 13.8.2 Procedure

Follow this procedure:

1. Push the joystick to display the menu system.
2. Use the joystick to go to  (Settings).

3. Push the joystick to display the *Settings* menu.
4. Select *Device settings* and push the joystick.
5. Select *Set up camera* and push the joystick.
6. Select *Continuous autofocus*. If the check box is unchecked, push the joystick to enable continuous autofocus.
7. Aim the camera toward the object of interest. The camera will now continuously autofocus.

**Note** To pause continuous autofocusing, push the Autofocus/Save button half-way down.

## 13.9 Operating the laser pointer

**Note** The laser pointer is enabled by a setting. Select  (*Settings*) > *Device settings* > *Set up camera* > *Lamp & laser* > *Enable lamp & laser*.

### 13.9.1 Figure

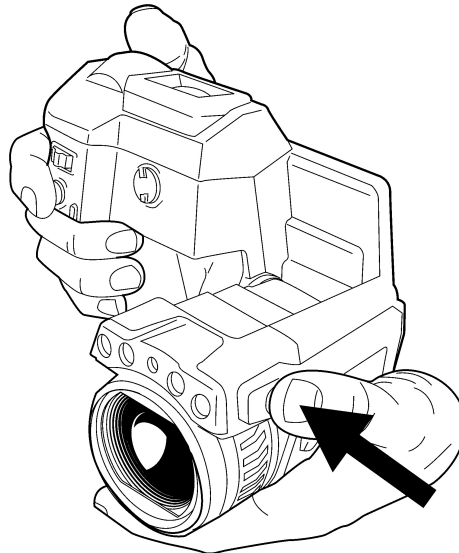

### 13.9.2 Procedure

Follow this procedure:

1. To turn on the laser pointer, push and hold the laser button.
2. To turn off the laser pointer, release the laser button.

**Note**

- A warning indicator is displayed on the screen when the laser pointer is turned on.
- The position of the laser dot is indicated on the infrared image (depending on the camera model).

---

## 13.10 Using the digital zoom function

### 13.10.1 Figure

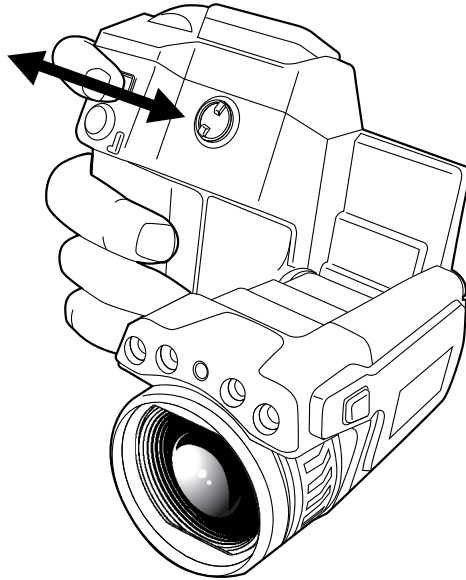

### 13.10.2 Procedure

Follow this procedure:

1. To zoom, push the zoom button left or right.

## 13.11 Changing lenses

Follow this procedure:

1. Take a firm grip around the outermost part of the lens.

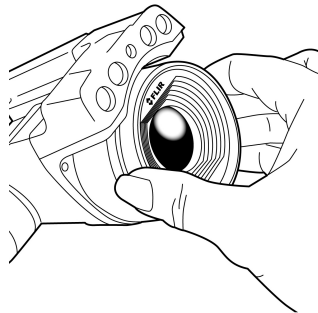

2. Rotate the lens 30° degrees counter-clockwise.

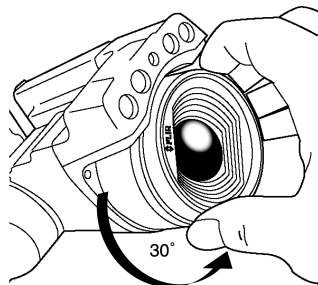

3. Carefully pull out the lens from the lens bayonet mount.

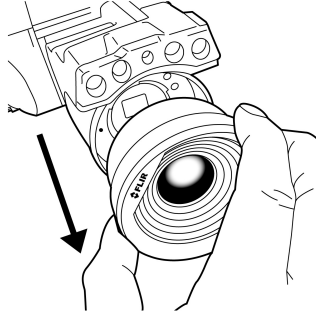

4. The infrared detector is now fully exposed. Do not touch this surface. If you see dust on the detector, follow the instructions in 26.3 *Infrared detector*, page 76.

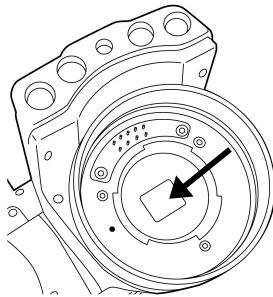

5. Note the index marks on the lens bayonet mount and on the lens.

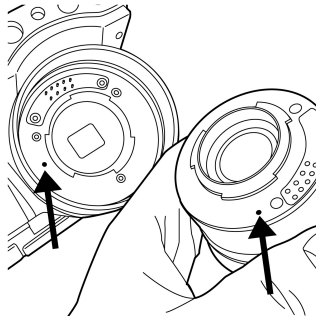

6. Align the lens correctly to the bayonet mount.

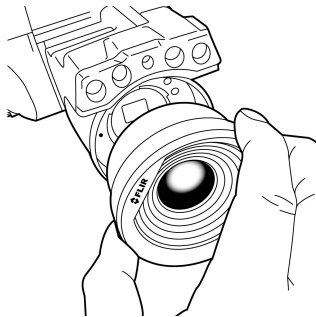

7. Carefully push the lens into position.

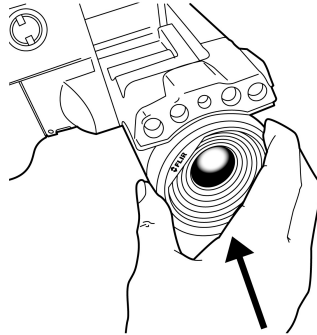

8. Rotate the lens 30° degrees clockwise.

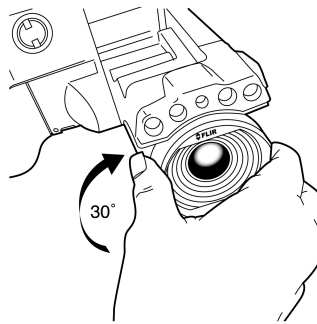

## 13.12 Calibrating the compass

### 13.12.1 Procedure

Follow this procedure:

1. Push the joystick to display the menu system.
2. Use the joystick to go to  (*Settings*).
3. Push the joystick to display the *Settings* menu.
4. Select *Device settings* and push the joystick.
5. Select *GPS & compass* and push the joystick.
6. Select *Compass*. If the *Compass* check box is unchecked, push the joystick to enable the compass.
7. Select *Calibrate compass* and push the joystick. Follow the on-screen instructions.

**Note** You have to rotate the camera slowly.

## 13.13 Changing the viewfinder eyecup



### CAUTION

**Applicability:** Cameras with a viewfinder.

Make sure that the beams from the intensive energy sources do not go into the viewfinder. The beams can cause damage to the camera. This includes the devices that emit laser radiation, or the sun.

**Note** This item is dependent on the camera model.

---

Follow this procedure:

1. Put your thumbs at the lower part of the eyecup. Push the eyecup horizontally, away from the touch-screen LCD side, until the eyecup slides out from its mount.

**Note** To remove the eyecup, you must slide it out from its mount. Do not pull the eyecup straight up.

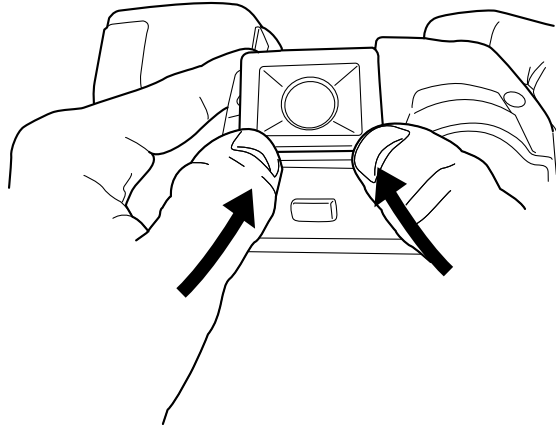

2. Note the grooves on the eyecup mount on the camera and on the new eyecup.

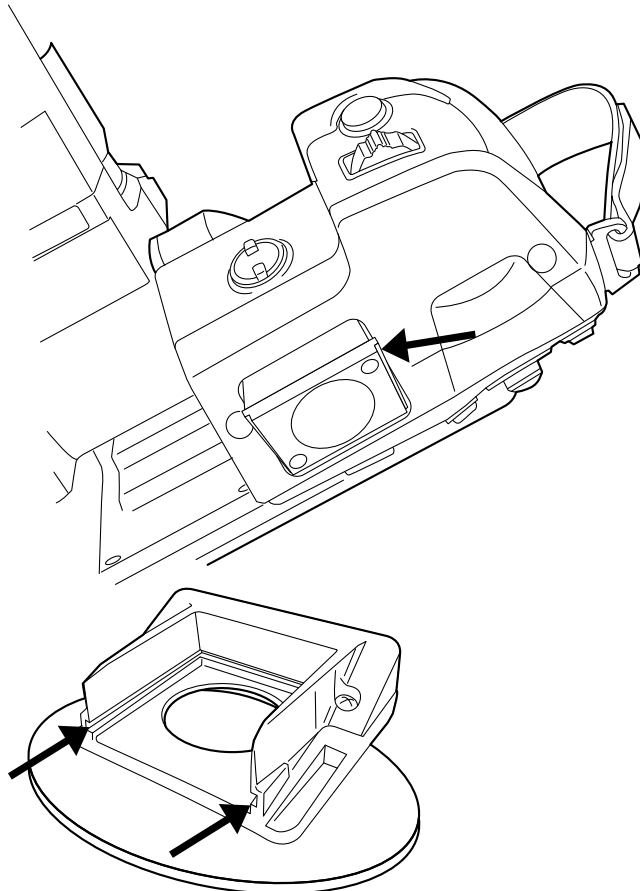

3. Align the new eyecup with the eyecup mount on the camera.

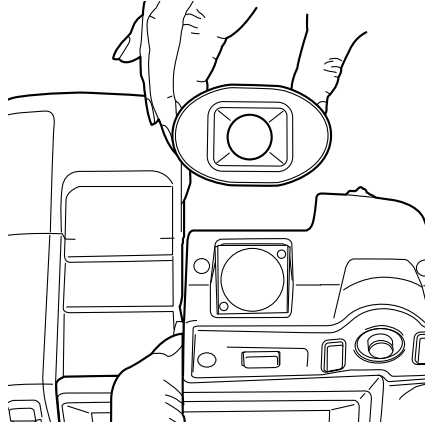

4. Carefully slide the eyecup into position.

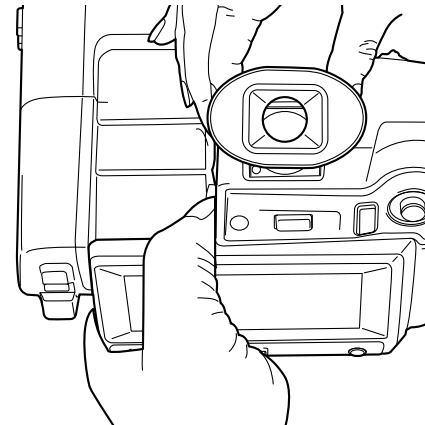

## 13.14 Using the camera lamp as a flash

### 13.14.1 General

The camera lamp can be used as a flash for the digital camera. When the flash function is activated, the camera lamp will flash when an image is saved by pushing the Autofocus/Save button fully down.

### 13.14.2 Procedure

Follow this procedure:

1. Push the joystick to display the menu system.
2. Use the joystick to go to  (*Settings*).
3. Push the joystick to display the *Settings* menu.
4. Select *Device settings* and push the joystick.
5. Select *Set up camera* and push the joystick.
6. Select *Lamp & laser* and push the joystick.
7. Select *Enable lamp & laser*. If the check box is unchecked, push the joystick to enable the camera lamp.
8. Select *Use lamp as flash*. If the check box is unchecked, push the joystick to activate the flash function.



## 14.1 Saving an image

### 14.1.1 General

You can save images to a memory card.

The camera saves an image file including all thermal and visual information. This means that you can open an image file at a later stage and, for example, select another image mode, apply color alarms, and add measurement tools.

The image jpg file is fully radiometric and saved lossless, which enables full post-processing in FLIR Tools. There is also a regular jpg part (lossy) for convenient viewing in non-FLIR Systems software (Explorer).

### 14.1.2 About UltraMax

UltraMax is an image enhancement feature that increases the image resolution and lowers the noise, making small objects easier to see and measure. An UltraMax image is twice as wide and high as an ordinary image.

When an UltraMax image is captured by the camera, several ordinary images are saved in the same file. Capturing all the images can take up to 1 second. To fully utilize UltraMax, the images need to be slightly different, which can be accomplished by a slight movement of the camera. You should hold the camera firmly in your hands (do not put it on a tripod), which will make these images vary just a little during the capture. Correct focus, a high-contrast scene, and a non-moving target are other conditions that help to achieve a good-quality UltraMax image.

At the moment, only FLIR Tools has the ability to process UltraMax images. Other FLIR software will treat the image as a regular image.

### 14.1.3 Image capacity

The capacity of a 4 GB memory card is theoretically 3600 images (with no annotations).

### 14.1.4 Naming convention



The naming convention for image files is FLIRxxxx.jpg, where xxxx is a unique counter.

### 14.1.5 Procedure

Follow this procedure:

1. To save an image, push the Autofocus/Save button fully down.

#### Note

- Depending on the settings in  (*Settings*) > *Save options*, the following may happen:
  - A preview image is displayed before the image is saved.
  - An annotation tool or the annotation menu is displayed when the image has been saved.
- To configure UltraMax, select  (*Settings*) > *Save options* > *Image resolution = UltraMax*.
- The camera can be configured to also save the visual image as a separate file. Select  (*Settings*) > *Save options* > *Photo as separate JPEG = On*.

## 14.2 Previewing an image



### 14.2.1 General

You can preview an image before you save it. This enables you to see if the image contains the information you want before you save it. You can also adjust and edit the image.

**Note** The camera must be configured to display a preview image before saving. Select  (Settings) > Save options > Preview image before saving = On.

### 14.2.2 Procedure

Follow this procedure:

1. To preview an image, push the Autofocus/Save button fully down. This displays the preview.
2. Manual image adjust mode is now active, and the status icon  is displayed. For image adjustment instructions, see 14.5 *Adjusting an infrared image*, page 35.
3. To edit the image, push the joystick. This displays a context menu. For editing instructions, see 14.4 *Editing a saved image*, page 34.
4. Do one of the following:
  - To save the image, push the Autofocus/Save button fully down.
  - To exit preview mode without saving, push the Back button .



## 14.3 Opening a saved image

### 14.3.1 General

When you save an image, the image file is stored on the memory card. To display the image again, open it from the image archive.

### 14.3.2 Procedure

Follow this procedure:

1. Push the Image archive button .
2. Move the joystick up/down or left/right to select the image you want to view.
3. Push the joystick. This will display the image at full size.
4. Do one or more of the following:
  - To switch between an infrared image and a visual image, move the joystick up/down.
  - To view the previous/next image, move the joystick left/right.
  - To edit the image, add annotations, display information, or delete the image, push the joystick. This displays a context menu.
  - To return to the image archive overview, push the Back button .









## 14.4 Editing a saved image

### 14.4.1 General

You can edit a saved image. You can also edit an image in preview mode.

### 14.4.2 Procedure

Follow this procedure:

1. Open the image in the image archive.
2. Push the joystick and select  (*Edit*) from the menu.
3. Manual image adjust mode is now active, and the status icon  is displayed. For image adjustment instructions, see 14.5 *Adjusting an infrared image*, page 35.
4. Push the joystick. This displays a context menu.
  - Select  (*Cancel*) to exit edit mode.
  - Select  (*Measurement parameters*) to change the global parameters.
  - Select  (*Image mode*) to change the image mode.
  - Select  (*Measurement*) to add a measurement tool.
  - Select  (*Color*) to change the color palette or set a color alarm.
  - Select  (*Save*) to save and exit edit mode.

## 14.5 Adjusting an infrared image

### 14.5.1 General

An infrared image can be adjusted automatically or manually. When manual image adjust mode is active, the status icon  is displayed.

- In live mode, push the button  to switch between automatic and manual image adjust modes. You can also switch between the modes by touching the temperature scale on the screen.
- In preview/edit mode, manual image adjust mode is active.

### 14.5.2 Example 1

Here are two infrared images of a building. In the left image, which is auto-adjusted, the large temperature span between the clear sky and the heated building makes a correct analysis difficult. You can analyze the building in more detail if you change the temperature scale to values close to the temperature of the building.

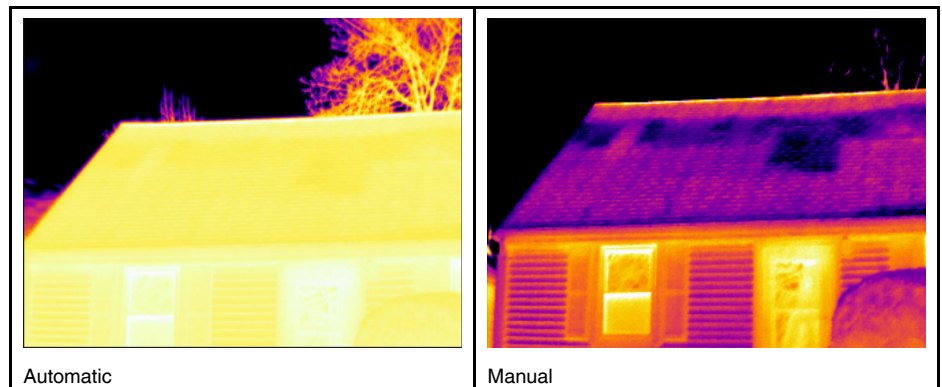

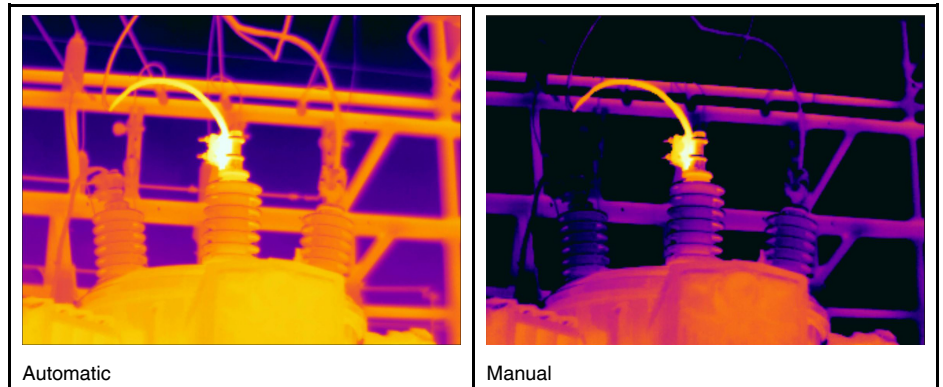

### 14.5.3 Example 2

Here are two infrared images of an isolator in a power line. To make it easier to analyze the temperature variations in the isolator, the temperature scale in the right image has been changed to values close to the temperature of the isolator.



### 14.5.4 Procedure

Follow this procedure:

1. In live mode, push the button  to enter manual image adjust mode.
2. To change the temperature scale minimum and maximum limits simultaneously, move the joystick up/down.
3. To change the temperature scale minimum or maximum limit, do the following:
  - Move the joystick left/right to select (highlight) the maximum or minimum temperature.
  - Move the joystick up/down to change the value of the highlighted temperature.
4. (Optional step). In preview/edit mode, push the button  to perform a one-shot auto-adjust sequence.

## 14.6 Performing a non-uniformity correction (NUC)

### 14.6.1 What is a non-uniformity correction?

A non-uniformity correction is *an image correction carried out by the camera software to compensate for different sensitivities of detector elements and other optical and geometrical disturbances*<sup>1</sup>.

### 14.6.2 When to perform a non-uniformity correction?

The non-uniformity correction process should be carried out whenever the output image becomes spatially noisy. The output can become spatially noisy when the ambient temperature changes (such as from day to night operation, and vice versa).

### 14.6.3 Procedure

To perform a non-uniformity correction, push and hold the Image archive button  for more than 2 seconds.

1. Definition from the impending international adoption of DIN 54190-3 (Non-destructive testing – Thermographic testing – Part 3: Terms and definitions).

## 14.7 Changing the temperature range

### 14.7.1 General

You must change the temperature range according to the expected temperature of the object you are inspecting.

### 14.7.2 Procedure

Follow this procedure:

1. Push the joystick to display the menu system.
2. Use the joystick to go to  (*Settings*).
3. Push the joystick to display the *Settings* menu.
4. Select *Device settings* and push the joystick.
5. Select *Set up camera* and push the joystick.
6. Select *Camera temperature range* and push the joystick.
7. Select the appropriate temperature range and push the joystick.

**Note** You can also assign the function *Switch temperature range* to the programmable button. Select  (*Settings*) > *Programmable button* > *Switch temperature range*.

## 14.8 Hiding overlay graphics (programmable button)

### 14.8.1 General

Overlay graphics provide information about an image, e.g., measurement functions and parameters. You can choose to hide all overlay graphics.

### 14.8.2 Procedure

Follow this procedure:

1. Push the joystick to display the menu system.
2. Use the joystick to go to  (*Settings*).
3. Push the joystick to display the *Settings* menu.
4. Select *Programmable button* and push the joystick.
5. Select *Hide graphics* and push the joystick. You have now assigned this function to the button **P**. This is a programmable button, and you can assign other functions to it.

**Note** Other functions that can be associated with the programmable button include the following:

- *Hide graphics*
- *Calibrate*
- *Switch Thermal <> Digital camera*
- *Switch Thermal <> Thermal MSX*
- *Switch 1x zoom <> Max zoom*
- *Switch between two latest palettes*
- *Switch temperature range*
- *Continuous autofocus* (not supported by all camera models)

## 14.9 Changing the color palette

### 14.9.1 General

You can change the color palette that the camera uses to display different temperatures. A different palette can make it easier to analyze an image.

### 14.9.2 Procedure

Follow this procedure:

1. Push the joystick to display the menu system.
2. Use the joystick to go to  (*Color*).
3. Push the joystick to display a submenu.
4. Use the joystick to select a different palette.
5. Push the joystick.



## 14.10 Deleting an image

### 14.10.1 General

You can delete an image from the memory card.

### 14.10.2 Procedure

Follow this procedure:

1. Push the Image archive button .
2. Move the joystick up/down or left/right to select the image you want to delete.
3. Push the joystick to display the image.
4. Push the joystick to display a menu.
5. On the menu, select  (*Delete*).
6. Push the joystick and confirm the choice.

**Note** Note that both images in the image file (thermal and visual) will be deleted.

## 14.11 Deleting all images

### 14.11.1 General

You can delete all images from the memory card.

### 14.11.2 Procedure

Follow this procedure:

1. Push the joystick to display the menu system.
2. Use the joystick to go to  (*Settings*).
3. Push the joystick to display the *Settings* menu.
4. Select *Reset options* and push the joystick.
5. Select *Delete all saved images...* and confirm the choice.

## 14.12 Creating a PDF report in the camera

### 14.12.1 General



You can create a PDF report and save it to the memory card. You can then transfer the PDF report to a computer, iPhone, or iPad using FLIR Tools, and send the report to a customer.

### 14.12.2 Naming convention

The naming convention for report files is REPORTxxxx.jpg, where xxxx is a unique counter.

### 14.12.3 Procedure

Follow this procedure:

1. Push the Image archive button .
2. Move the joystick up/down or left/right to select an image.
3. Push the joystick to display the image.
4. Push the joystick to display a context menu.
5. Select  (*Information & reports*) and push the joystick. This displays information about the image.
6. Select *Create report* and push the joystick.  
The created report will be available in the archive.

## 15.1 General

The camera captures both thermal and visual images at the same time. By your choice of image mode, you select which type of image to display on the screen.

The camera supports the following image modes:

- *Thermal MSX* (Multi Spectral Dynamic Imaging): The camera displays infrared images where the edges of the objects are enhanced with visual image details.
- *Thermal*: A full infrared image is displayed.
- *Picture in picture*: An infrared image frame is displayed on top of the visual image.
- *Digital camera*: The visual image captured by the digital camera is displayed.

### Note

- These image modes only work correctly for calibrated lenses. The lens that ships with the camera is factory calibrated. To have a new lens calibrated, you must send in the camera and the lens to your local service department.
- All thermal and visual information is stored when an image is saved. This means that you can edit the image later, in the image archive or in FLIR Tools, and select any of the image modes.

## 15.2 Image examples

This table explains the different types of image modes.



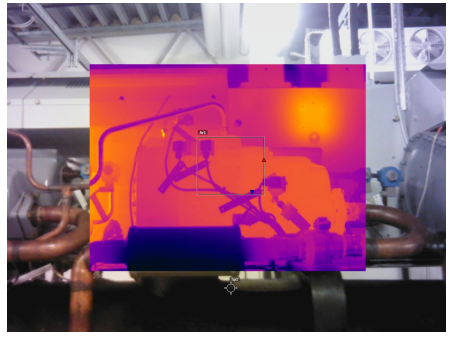
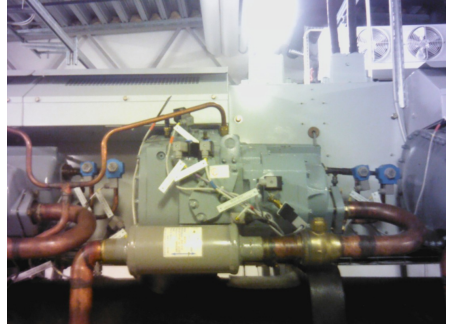





Image mode	Image
<i>Thermal</i>	
<i>Thermal MSX</i>	



Image mode	Image
<i>Picture in picture</i>	
<i>Digital camera</i>	

### 15.3 Selecting the image mode

Follow this procedure:







1. Push the joystick to display the menu system.
2. Use the joystick to go to  (*Image mode*).
3. Push the joystick to display a submenu.
4. Use the joystick to go to one of the image modes:
  -  (*Thermal MSX*)
  -  (*Thermal*)
  -  (*Picture in picture*)
  -  (*Digital camera*)
5. Push the joystick confirm.
6. If *Picture in picture* mode is selected, you can at this point move and resize the infrared image frame using the touch screen.

## 16.1 General

To measure a temperature, you can use one or more measurement tools, e.g., a spot-meter or a box.

## 16.2 Adding/removing measurement tools

Follow this procedure:

1. Push the joystick to display the menu system.
2. Use the joystick to go to  (*Measurement*).
3. Push the joystick to display a submenu.
  - Select  (*No measurements*) to remove all tools.
  - Select  (*Center spot*) to add a center spot.
  - Select  (*Hot spot*) to add a hot spot detection within a box area.
  - Select  (*Cold spot*) to add a cold spot detection within a box area.
  - Select  (*User preset 1*) to add user preset 1. (Not available in all camera models.)
  - Select  (*User preset 2*) to add user preset 2. (Not available in all camera models.)
4. Push the joystick. This displays the measurement tool or the group of preset tools on the screen.



## 16.3 Working with user presets

### 16.3.1 General





A user preset is a measurement tool, or a group of measurement tools, with predefined characteristics.

### 16.3.2 Procedure

Follow this procedure:

1. Push the joystick to display the menu system.
2. Use the joystick to go to  (*Settings*).
3. Push the joystick to display the *Settings* menu.
4. Select *Define user presets* and push the joystick.
5. Select *Define preset 1* or *Define preset 2* and push the joystick. This displays a context menu.
6. Select  (*Add measurement*).

7. Push the joystick. This displays a submenu.

- Select  (*Add spot*) to add a spot.
- Select  (*Add box*) to add a box.
- Select  (*Add circle*) to add a circle.
- Select  (*Add line*) to add a line.
- Select  (*Add delta*) to set up a differential calculation.

8. Push the joystick. This displays the measurement tool on the screen.

9. Push the joystick. This displays a context menu, where you can select one or more of the following actions (depending on the type of tool):

- Remove the tool.
- Resize, move, center, and rotate the tool.
- Display maximum, minimum, and average values.
- Set alarms.
- Set local parameters.
- When completed, select  (*Done*).

10. When all measurement tools have been added, select  (*Save as preset*).

## 16.4 Resizing or moving a measurement tool

### 16.4.1 General

You can resize and move a measurement tool.

### 16.4.2 Procedure

#### Note

- This procedure assumes that you have previously laid out a measurement tool or user preset on the screen.
- You can also move and resize the measurement tool by touching the screen.



Follow this procedure:

1. To select the measurement tool, touch the tool on the screen. The tool is now displayed with one or more handles.

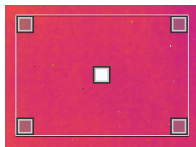
Spot measurement tool: 

Area measurement tool: 

2. Push the joystick—or touch and hold the tool. This displays a context menu.

- Select  (*Resize*) to change the size of the tool.
- Select  (*Move*) to move the tool.

3. Move the joystick up/down and left/right to resize or move the tool.

4. When completed, push the joystick and select  (*Done*).

## 16.5 Changing object parameters

### 16.5.1 General

For accurate measurements, you must set the object parameters.

### 16.5.2 Types of parameters

The camera can use these object parameters:

- *External IR window compensation*, i.e., the temperature of any protective windows, external lenses (e.g., the close-up lens), etc., that are set up between the camera and the object of interest. If no protective window, protective shield, or external lens is used, this value is irrelevant and should be left inactive.
- *Object distance*, i.e., the distance between the camera and the object of interest.
- *Atmospheric temperature*, i.e., the temperature of the air between the camera and the object of interest.
- *Relative humidity*, i.e., the relative humidity of the air between the camera and the object of interest.
- *Reflected temperature*, which is used when compensating for the radiation from the surroundings reflected by the object into the camera. This property of the object is called “reflectivity”.
- *Emissivity*, i.e., how much radiation an object emits, compared with the radiation of a theoretical reference object at the same temperature (called a “blackbody”). The opposite of emissivity is reflectivity. The emissivity determines how much of the radiation originates from the object as opposed to being reflected by it.

**Note** There is an *Emissivity mode* setting, which you can use to enter the emissivity by material instead of by value. Select  (*Settings*) > *Device settings* > *Set up camera* > *Emissivity mode* > *Select from materials table*.

Of the object parameters, *Emissivity* is the most important parameter to set correctly. If the *Emissivity* is set to a low value, the *Reflected temperature* also becomes important. The parameters *Object distance*, *Atmospheric temperature*, and *Relative humidity* are relevant for longer distances. The *External IR window compensation* must be activated if a protective window or external lens is used.

### 16.5.3 Recommended values

If you are unsure about the values, the following are recommended:

Object distance	1.0 m (3.3')
Atmospheric temperature	20°C (69°F)
Relative humidity	50%
Reflected temperature	20°C (69°F)
Emissivity	0.95

### 16.5.4 Procedure







You can set the object parameters globally. You can also change the *Emissivity*, *Reflected temperature*, and *Object distance* parameters locally for a measurement tool.

Local parameters are normally only effective for a fixed setup, where each measurement tool is set to a specific object of interest. In a general handheld application, the global parameters are usually sufficient.

**Note** Of the object parameters, *Emissivity* and *Reflected temperature* are the two most important to set correctly in the camera.

#### 16.5.4.1 Setting global parameters

Follow this procedure:





1. Push the joystick to display the menu system.
2. Use the joystick to go to  (*Measurement parameters*).
3. Push the joystick to display a submenu. Use the joystick to select one or more of the global object parameters:
  -  (*External IR window compensation*)
  -  (*Object distance*)
  -  (*Atmospheric temperature*)
  -  (*Relative humidity*)
  -  (*Reflected temperature*)
  -  (*Emissivity*)
4. Push the joystick to display a dialog box.
5. Use the joystick to change the parameter.
6. Push the joystick. This closes the dialog box.

#### 16.5.4.2 Changing local parameters

You can change the local parameters for a measurement tool.

A *P* next to the measurement tool on the screen indicates that local parameters are activated for the tool.

Follow this procedure:

1. To select the measurement tool, touch the tool on the screen. The tool is now displayed with one or more handles.
2. Push the joystick—or touch and hold the tool. This displays a context menu.
3. Use the joystick to go to  (*Use local parameters*).
4. Push the joystick.  (icon with gray indicator) is displayed.
5. Push the joystick to activate the use of local parameters.  (icon with blue indicator) is displayed together with a submenu.
6. Use the joystick to select an object parameter.
7. Push the joystick to display a dialog box.
8. Use the joystick to change the parameter.
9. Push the joystick. This closes the dialog box.
10. When completed, push the joystick and select  (*Done*).

#### 16.5.5 Related topics

For in-depth information about parameters, and how to correctly set the emissivity and reflected apparent temperature, see section 28 *Thermographic measurement techniques*, page 81.

## 16.6 Displaying values in the result table and displaying a graph











### 16.6.1 General

For the box, circle, and line tools, you can set the camera to display the maximum, minimum, and average values in the result table.

For the line tool, you can also display a graph.

### 16.6.2 Procedure

Follow this procedure:

1. To select the measurement tool, touch the tool on the screen. The tool is now displayed with one or more handles.
2. Push the joystick—or touch and hold the tool. This displays a context menu.
3. Use the joystick to go to (depending on the tool) , , or  (*Max/Min/Avg/Alarm*) or (*Graph/Max/Min/Avg/Alarm*).
4. Push the joystick. This displays a submenu.
  - (Option available for the line tool.) Select  (*Graph*) and push the joystick to display a graph.
  - Select  (*Max*) and push the joystick to display the maximum value.
  - Select  (*Min*) and push the joystick to display the minimum value.
  - Select  (*Avg*) and push the joystick to display the average value.
  - (Optional step.) You can choose to show or hide the maximum and minimum markers (the hot/cold spots). Select  (*Max & min markers*) and push the joystick to toggle:
    - When  (icon with grey indicator) is displayed, the markers are hidden.
    - When  (icon with blue indicator) is displayed, the markers are shown.
5. When completed, move the joystick down to close the submenu.
6. Select  (*Done*) and push the joystick.

## 16.7 Creating and setting up a difference calculation

### 16.7.1 General

A difference calculation gives the difference between the values of two known measurement results.

### 16.7.2 Procedure

#### Note

- You can set up a difference calculation when defining user presets, or when editing an image in the archive.
- This procedure assumes that you have previously laid out at least one measurement tool on the screen.

### 16.7.2.1 Procedure

Follow this procedure:

1. To set up a difference calculation, select  $\Delta$  (Add delta).
2. Push the joystick. This displays a dialog box where you can select the measurement tools that you want to use in the difference calculation. You can also select a fixed-temperature reference.

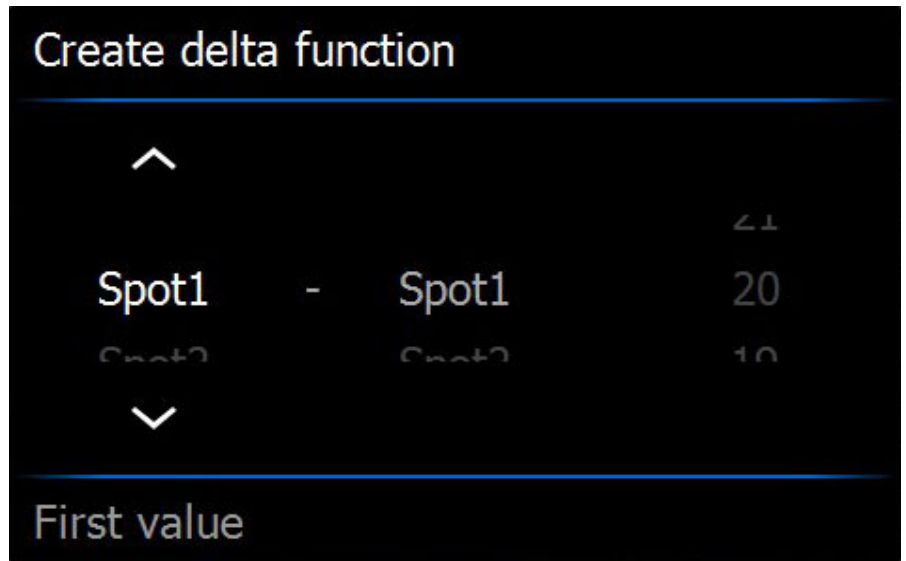

3. Push the joystick. The result of the difference calculation is now displayed on the screen.

## 16.8 Setting a measurement alarm

### 16.8.1 General

You can make the camera trigger an alarm when certain measurement conditions are met.



### 16.8.2 Types of alarm

You can choose between the following alarm types:

- *Above*: Triggers an alarm when the temperature is above the preset alarm temperature.
- *Below*: Triggers an alarm when the temperature is below the preset alarm temperature.

### 16.8.3 Alarm signals

When an alarm is set, the symbol  is displayed in the result table.



When an alarm is triggered, the value in the result table is displayed in red (above alarm) or blue (below alarm) and the symbol  (above alarm) or  (below alarm) is blinking. You can also set an audible alarm (there will be a “beep” when the alarm is triggered).

### 16.8.4 Procedure

There are different procedures for setting up an alarm for a spot, box, circle, or line and for a difference calculation.

#### 16.8.4.1 Setting up an alarm for a spot





Follow this procedure:

1. To select the spot, touch the tool on the screen. The tool is now displayed with a frame.
2. Push the joystick—or touch and hold the tool. This displays a context menu.
3. Use the joystick to go to  (*Set alarm on spot*).
4. Push the joystick. This displays a dialog box where you can define the settings for the alarm.
  - *Alarm condition*: The condition that triggers the alarm. Applicable values are *Above*, *Below*, or *Off*.
  - *Alarm limit*: The temperature value that will be the critical condition when an alarm is triggered or not.
  - *Alarm sound*: Applicable values are *Beep* or *No sound*.
5. Push the joystick. This closes the dialog box.
6. Push the joystick and select  (*Done*).

#### 16.8.4.2 Setting up an alarm for a box, circle, or line

**Note** This procedure assumes that you have previously set the camera to display at least one value (maximum, minimum, or average) in the result table.

Follow this procedure:



1. To select the measurement tool, touch the tool on the screen. The tool is now displayed with one or more handles.
2. Push the joystick—or touch and hold the tool. This displays a context menu.
3. Use the joystick to go to (depending on tool) , , or  (*Max/Min/Avg/Alarm*) or (*Graph/Max/Min/Avg/Alarm*).
4. Push the joystick. This displays a submenu.
5. Select  (*Set alarm*).
6. Push the joystick. This displays a dialog box where you can define the settings for the alarm.
  - *Alarm condition*: The condition that triggers the alarm. Applicable values are *Above*, *Below*, or *Off*.
  - *Select measurement*: Applicable settings are the values you have previously defined (*Max*, *Min*, and/or *Avg*).
  - *Alarm limit*: The temperature value that will be the critical condition when an alarm is triggered or not.
  - *Alarm sound*: Applicable values are *Beep* or *No sound*.
7. Push the joystick. This closes the dialog box.
8. Push the joystick and select  (*Done*).

#### 16.8.4.3 Setting up an alarm for a difference calculation

**Note**

- You can set up an alarm for a difference calculation when defining user presets, or when editing an image in the archive.
- This procedure assumes that you have previously set up a difference calculation.

Follow this procedure:

1. Select  (*Add measurement*). This displays a submenu.
2. Select  (*Select*). This displays a dialog box.
3. Select *Delta*. This displays a context menu.
4. Use the joystick to go to  (*Set alarm on delta*).



5. Push the joystick. This displays a dialog box where you can define the settings for the alarm.
  - *Alarm condition*: The condition that triggers the alarm. Applicable values are *Above*, *Below*, or *Off*.
  - *Alarm limit*: The temperature value that will be the critical condition when an alarm is triggered or not.
  - *Alarm sound*: Applicable values are *Beep* or *No sound*.
6. Push the joystick. This closes the dialog box.

# Fetching data from external FLIR meters

## 17.1 General

You can fetch data from an external FLIR meter and merge this data into the infrared image.

When the camera is connected to a FLIR meter via Bluetooth, the measurement value from the meter is displayed in the result table of the camera. The FLIR meter value is also added to the information saved in the image file. In preview mode and when editing an image in the archive, you can add more than one value from the same FLIR meter.

### Note

- Before you can use a FLIR meter with the camera, you need to pair the devices. For more information, see 11 *Pairing Bluetooth devices*, page 21.
- To add more than one FLIR meter value when saving an image, preview mode must be enabled. Select  (*Settings*) > *Save options* > *Preview image before saving* = *On*.

In preview mode and when editing an image in the archive, you can do the following:

- Push the programmable button **P** to add the value currently displayed by the FLIR meter.
- Push and hold the programmable button **P** to remove all FLIR meter values from the image.

**Note** Any function assigned to the programmable button is temporarily disabled when in preview mode or when editing an image in the archive.

## 17.2 Supported FLIR meters

- FLIR CM78
- FLIR CM83
- FLIR DM93
- FLIR MR77

## 17.3 Technical support for external meters

Technical support	
Website	<a href="http://support.flir.com">http://support.flir.com</a>
E-mail	TMSupport@flir.com
Phone	855-499-3662
Repairs	repair@flir.com

## 17.4 Typical moisture measurement and documentation procedure

### 17.4.1 General

The following procedure can form the basis for other procedures using FLIR meters and infrared cameras.

### 17.4.2 Procedure

Follow this procedure:

1. Use the infrared camera to identify any potential damp areas behind walls and ceilings.
2. Use the moisture meter to measure the moisture levels at various suspect locations that may have been found.
3. When an area of particular interest is located, store the moisture reading in the moisture meter's memory and identify the measurement area with a handprint or other thermal identifying marker.
4. Recall the reading from the meter memory. The moisture meter will now continuously transmit this reading to the infrared camera.
5. Use the camera to take a thermal image of the area with the identifying marker. The stored data from the moisture meter will also be saved on the image.

## 17.5 More information

For more information, see the users' manuals that are shipped with the FLIR meters.

## 18.1 Color alarms

### 18.1.1 General

By using color alarms (isotherms), anomalies can easily be discovered in an infrared image. The isotherm command applies a contrasting color to all pixels with a temperature above, below, or between the set temperature levels. The camera also features isotherm types that are specific to the building trade: condensation and insulation alarms.

You can make the camera trigger the following types of color alarms:

- *Above alarm*: This will apply a contrasting color to all pixels with a temperature above the specified temperature level.
- *Below alarm*: This will apply a contrasting color to all pixels with a temperature below the specified temperature level.
- *Interval alarm*: This will apply a contrasting color to all pixels with a temperature between two specified temperature levels.
- *Condensation alarm*: Triggers when the camera detects a surface where the relative humidity exceeds a preset value.
- *Insulation alarm*: Triggers when there is an insulation deficiency in a wall.

### 18.1.2 Image examples



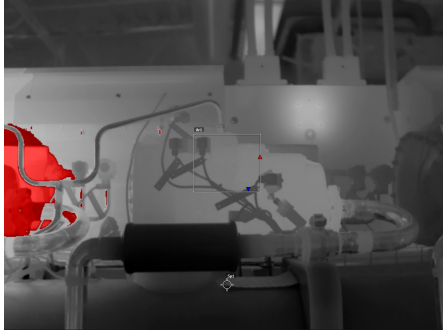
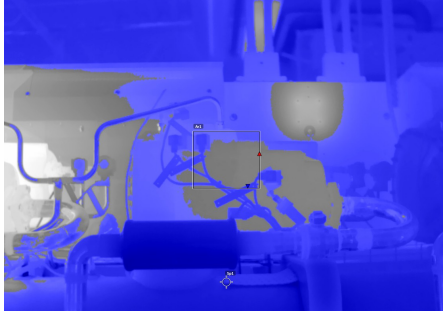

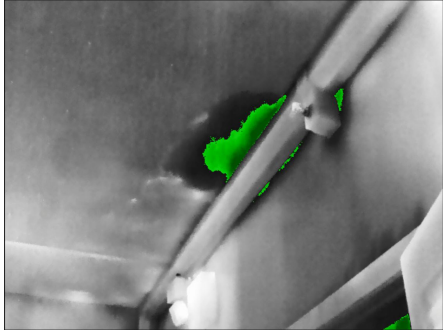
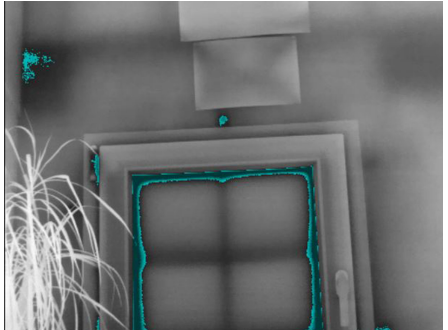
This table explains the different color alarms (isotherms).

Color alarm	Image
<i>Above alarm</i>	
<i>Below alarm</i>	

Color alarm	Image
<i>Interval alarm</i>	
<i>Condensation alarm</i>	
<i>Insulation alarm</i>	

## 18.2 Setting up above, below, and interval alarms

Follow this procedure:

1. Push the joystick to display the menu system.
2. Use the joystick to go to  (*Color*).
3. Push the joystick to display a submenu. Use the joystick to select the type of alarm:
  -  (*Above alarm*)
  -  (*Below alarm*)
  -  (*Interval alarm*)
4. Push the joystick. The threshold temperature is displayed at the bottom of the screen.

- 
5. To change the threshold temperature, do the following:
    - For the *Interval alarm*, move the joystick left/right to select the low/high-temperature value.
    - Move the joystick up/down to change the threshold temperature.

## 18.3 Building isotherms

**Note** The Condensation and Insulation alarms are not supported by all camera models.

### 18.3.1 About the *Condensation alarm*

To detect areas with potential moisture problems, you can use the *Condensation alarm*. You can set the relative humidity above which the isotherm will colorize the image.



### 18.3.2 About the *Insulation alarm*

The *Insulation alarm* can detect areas where there may be an insulation deficiency in the building. It will trigger when the insulation level (which is called the thermal index in the camera) falls below a preset value of the energy leakage through a wall.

Different building codes recommend different values for the insulation level, but typical values are 60–80% for new buildings. Refer to your national building code for recommendations.

### 18.3.3 Setting up condensation and insulation alarms

Follow this procedure:

1. Push the joystick to display the menu system.
2. Use the joystick to go to  (*Color*).
3. Push the joystick to display a submenu. Use the joystick to select the type of alarm:
  -  (*Condensation alarm*)
  -  (*Insulation alarm*)
4. Push the joystick. This displays a dialog box where you can define the settings for the alarm.

For the *Condensation alarm*, the following parameters can be set:

- *Atmospheric temperature*: The current atmospheric temperature.
- *Relative humidity*: The current relative humidity.
- *Relative humidity limit*: The relative humidity level at which you want the alarm to be triggered. A relative humidity of 100% means that water vapor condenses from the air as liquid water (= dewpoint). A relative humidity of about 70% or above can cause mold.

For the *Insulation alarm*, the following parameters can be set:

- *Indoor temperature*: The current indoor temperature.
- *Outdoor temperature*: The current outdoor temperature.
- *Thermal index*: The insulation level, an integer between 0 and 100.

5. Push the joystick. This closes the dialog box.

## 19.1 General

You can save additional information together with an infrared image by using annotations. Annotations make reporting and post-processing more efficient, by providing essential information about the image, e.g., conditions and information about where an image is taken.

Annotations are added to the image file, and can be viewed and edited in the image archive, and also when moving files from the camera to reporting software on the computer.

- You can set the camera to display annotation tools before an image is saved. Select  (Settings) > Save options > Add annotation after saving.
- You can also add annotations to a saved image in the image archive.

**Note** This section describes the procedures for adding annotations to a saved image in the image archive. Adding annotations when saving an image works in a similar way.

## 19.2 Adding a note

### 19.2.1 General

A text note is grouped with the image file. Using this feature, you can annotate images by entering free-form text.

### 19.2.2 Procedure

Follow this procedure:

1. Open the image in the image archive.
2. Push the joystick. This displays a context menu.
3. Select  (Add note).
4. Push the joystick. This displays a soft keyboard where you can enter the text you want to save.

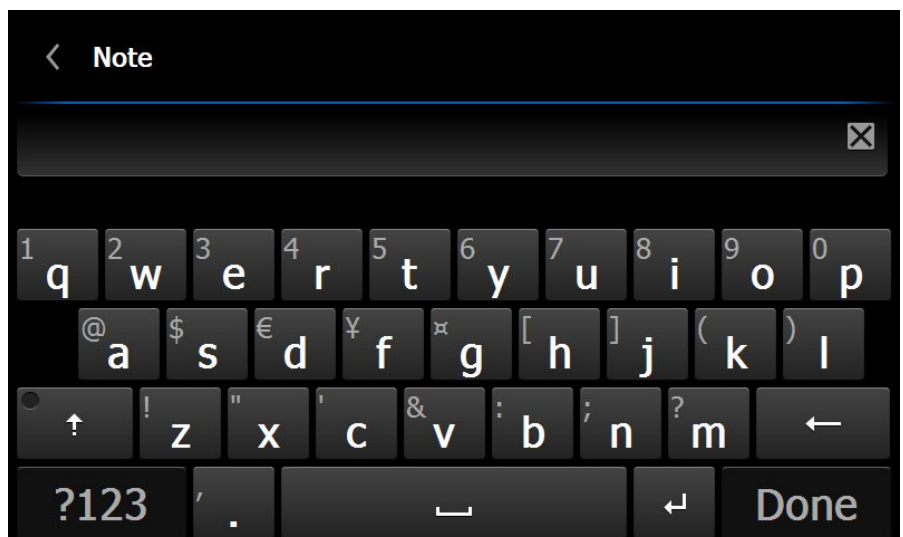

**Note** To select special characters, press and hold down the corresponding key on the soft keyboard.

5. When completed, touch *Done* on the soft keyboard.

## 19.3 Adding a table



### 19.3.1 General

You can save a table with textual information to the image file. This feature is a very efficient way of recording information when you are inspecting a large number of similar objects. The idea behind using a table with textual information is to avoid filling out forms or inspection protocols manually.

The camera has a number of default table templates. You can also import your own table templates from FLIR Tools. The templates are stored on the memory card.

### 19.3.2 Procedure

Follow this procedure:

1. Open the image in the image archive.
2. Push the joystick. This displays a context menu.
3. Select  (*Add table*) and push the joystick.
4. Select  (*Add table contents*) and push the joystick.
5. This displays the default table template that ships with the camera.

**Note** You can select another template by first selecting  (*Select default template*).

6. For each row in the table, do the following:
  - Push the joystick. This displays the predefined values.
  - Move the joystick up/down to select a predefined value. Push the joystick to confirm.
  - Instead of selecting a predefined value, you can select the keyboard  and enter other text.
7. When completed, select *Save & Exit* at the bottom of the table. Push the joystick to confirm.

## 19.4 Adding a voice annotation







### 19.4.1 General

A voice annotation is an audio recording that is saved to the infrared image file.

The voice annotation is recorded using a Bluetooth headset. The recording can be played back in the camera, and in image analysis and reporting software from FLIR Systems.

### 19.4.2 Procedure

Follow this procedure:

1. Open the image in the image archive.
2. Push the joystick. This displays a context menu.
3. Select  (*Add voice annotation*) and push the joystick.
4. To start a recording, select  (*Record*) and push the joystick.
5. To stop the recording, select  (*Stop*) and push the joystick.
6. To listen to the recording, select  (*Play*) and push the joystick.
7. To delete the recording, select  (*Delete*) and push the joystick.
8. When completed, select  (*Done*) and push the joystick.









## 19.5 Adding a sketch

### 19.5.1 General

You can add a freehand drawing to an image.

### 19.5.2 Procedure

Follow this procedure:



1. Open the image in the image archive.
2. Push the joystick. This displays a context menu.
3. Select  (*Add sketch*) and push the joystick.
4. You are now in sketch mode. Draw the sketch by touching the screen.
5. Push the joystick. This displays a context menu. Do one or more of the following:
  - To change the color of the sketch tools, select  (*Draw*) and push the joystick. Select the color and push the joystick.
  - To erase, select  (*Eraser*) and push the joystick. Erase parts of the sketch by touching the screen.
  - To add an arrow, circle, or cross, select  (*Stamp sketch*) and push the joystick. Select the type of stamp and push the joystick. The stamp is displayed in the center of the screen. You can move the stamp by touching the screen.
  - To clear, select  (*Clear all*) and push the joystick.
  - When the sketch is completed, select  (*Save*) and push the joystick.

## 20.1 General

You can program the camera to save images periodically (time lapse).

## 20.2 Procedure

Follow this procedure:

1. Push the joystick to display the menu system.
2. Use the joystick to go to  (*Recording mode*).
3. Push the joystick. This displays a submenu.
4. Select  (*Time lapse*).
5. Push the joystick. This displays a dialog box, where you can set the save conditions:
  - *Save interval*: Use the joystick to set the time interval between each saved image.
  - *Total number of images*: Periodic saving will stop when the set number of images have been saved.
6. Push the joystick. This closes the dialog box. The time interval is displayed at the top of the screen.
7. To manually start or stop periodic saving, briefly push and release the Autofocus/ Save button.

## 21.1 General



You can record and save video clips to the memory card.

**Note** The camera can be configured to save video in \*.mpg or \*.csq format. Select  (Settings) > Save options > Video compression.

- *Mpeg (\*.mpg)*: Mpeg recordings cannot be edited after the file has been saved.
- *Radiometric storage (\*.csq)*: A \*.csq file supports full radiometry but is only supported by FLIR Systems software. The file does not include any visual-image information.

## 21.2 Procedure

Follow this procedure:

1. Push the joystick to display the menu system.
2. Use the joystick to go to  (Recording mode).
3. Push the joystick. This displays a submenu.
4. Select  (Video) and push the joystick.
5. Do the following:
  - To start a recording, push and release the Autofocus/Save button. A counter at the top of the screen displays the duration of the recording.
  - To stop a recording, push and release the Autofocus/Save button.
6. The recording is automatically saved to the image archive, where you can play or delete it.

## 22.1 General

The screening alarm can be used, for example, at airports to detect passengers with elevated body temperatures, which may indicate the presence of a fever.

Activating the screening alarm will turn on a measurement box and screening data in the result table.

 The sampled average temperature.



 The alarm temperature.

 The measured temperature.

The alarm will trigger when the measurement box measures a temperature higher than the alarm temperature. The alarm temperature is, in turn, the sum of a specified allowed deviation and a sampled average value.

## 22.2 Procedure

Follow this procedure:

1. Enable the screening mode by selecting  (*Settings*) > *Device settings* > *Set up camera* > *Screening mode = On*.
2. Push the joystick to display the menu system.
3. Use the joystick to go to  (*Recording mode*).
4. Push the joystick. This displays a submenu.
5. Select  (*Screening*).
6. Push the joystick. This displays a dialog box where you can define the settings for the alarm.
  - *Allowed deviation*: The allowed deviation from the sampled average.
  - *Alarm sound*: Applicable values are *Beep* or *No sound*.
7. Push the joystick. This closes the dialog box.
8. Aim the camera toward a point of interest. The object should be within the frame of the measurement box.
9. Push and hold the programmable button **P** to reset the sampled average.
10. Push the programmable button **P** to sample.
11. Aim the camera toward more points of interest. Sample 10 times to build up a sample base by pushing the programmable button **P**.

The alarm is now set up and ready to use. Occasionally record a few samples if the alarm is used for a long time or if the conditions change.

### Note

- The algorithm has a memory of the last 10 samples. It discriminates between the highest and lowest values, and calculates an average of the remaining values.
- Do not modify the measurement setup or activate another alarm because this will deactivate the screening alarm.

## 23.1 General

The *Settings* menu includes the following:

- *Define user presets*
- *Save options*
- *Programmable button*
- *Reset options*
- *Device settings*

### 23.1.1 Define user presets

- *Define preset 1*
- *Define preset 2*

### 23.1.2 Save options

- *Preview image before saving*
- *Add annotation after saving*
- *Image resolution*
- *Video compression*
- *Photo as separate JPEG*

### 23.1.3 Programmable button

- *No action*
- *Hide graphics*
- *Calibrate*
- *Switch Thermal <> Digital camera*
- *Switch Thermal <> Thermal MSX*
- *Switch 1x zoom <> Max zoom*
- *Switch between two latest palettes*
- *Switch temperature range*
- *Continuous autofocus* (not supported by all camera models)

### 23.1.4 Reset options

- *Reset default camera mode...*
- *Reset device settings to factory default...*
- *Delete all saved images...*

**Note** When an option is selected, a dialog box is displayed with more information. You can choose to execute the reset/delete action or to cancel.



### 23.1.5 Device settings

- *Set up camera*
  - *Camera temperature range*: The temperature range used for measuring objects. You must change the temperature range according to the expected temperature of the object you are inspecting.
  - *Auto orientation*
  - *Continuous autofocus* (not supported by all camera models)
  - *Display intensity*
  - *Lamp & laser*
  - *Viewfinder intensity*
  - *HDMI*
  - *Emissivity mode*
- *Wi-Fi*: For more information, see 12 *Configuring Wi-Fi*, page 22.
- *GPS & compass*
- *Bluetooth including METERLiNK*: For more information, see 11 *Pairing Bluetooth devices*, page 21.

- *Language, time & units*
- *Camera information*: Information about the model, serial number, part number, and software versions. No changes can be made.

## 23.2 Procedure

Follow this procedure:

1. Push the joystick to display the menu system.
2. Use the joystick to go to  (*Settings*).
3. Push the joystick to display the *Settings* menu.
4. Use the joystick to select the setting you want to change.
5. To exit the *Settings* menu or a submenu, push the Back button .

[See next page]

# Camera housing

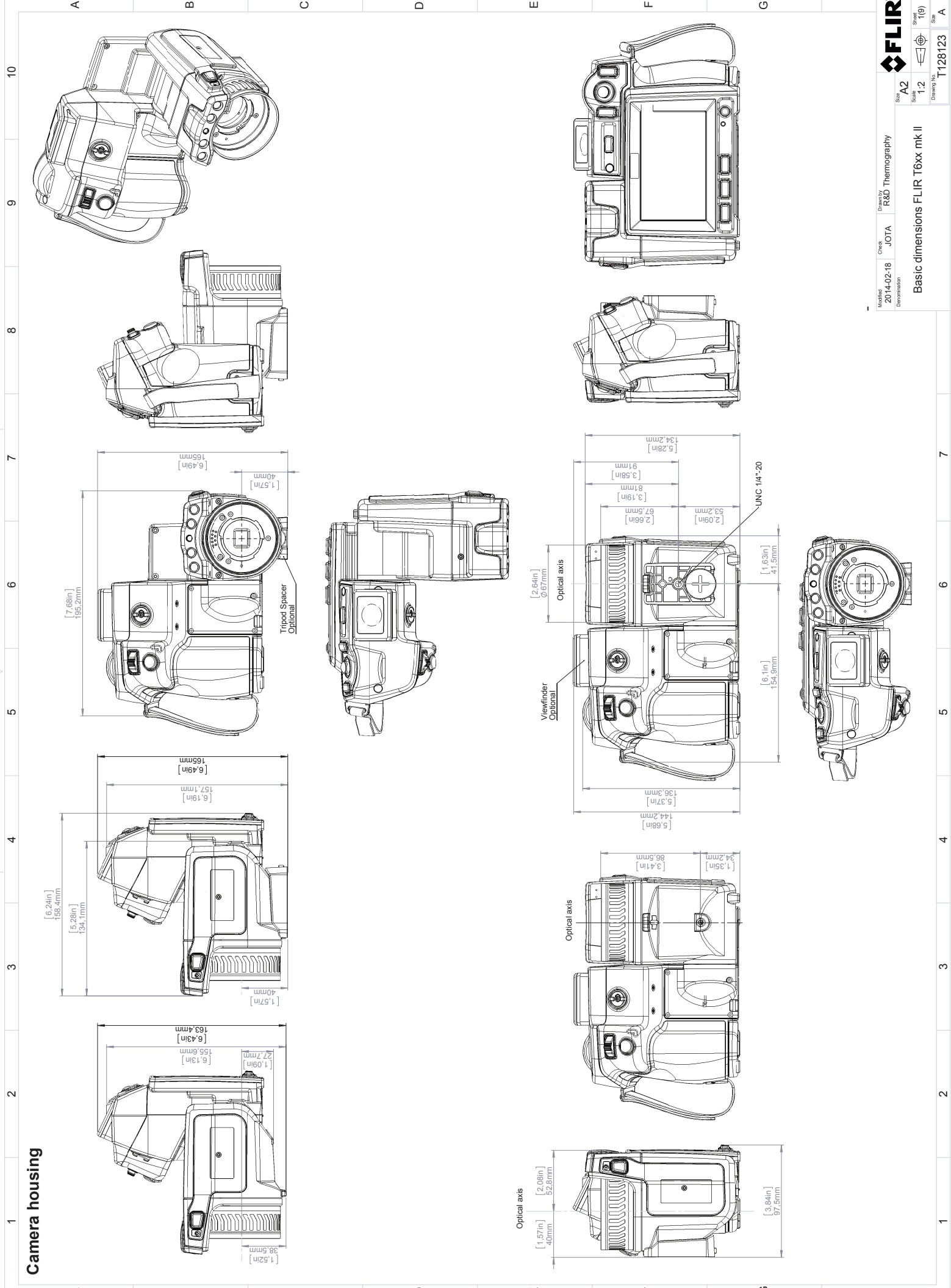

©2012 FLIR Systems, Inc. All rights reserved worldwide. No part of this drawing may be reproduced, stored in a retrieval system, or transmitted in any form, or by any means, electronic, mechanical, photocopying, recording, or otherwise, without written permission from FLIR Systems, Inc. Specifications subject to change without further notice. Dimensional data is based on nominal values. Products may be subject to regional market considerations. License procedures may apply. Product may be subject to US Export regulations. Please refer to exportquestions@flir.com with any questions. Diversion contrary to US law is prohibited.



# Camera with Lens IR f=6,5 mm (80°)

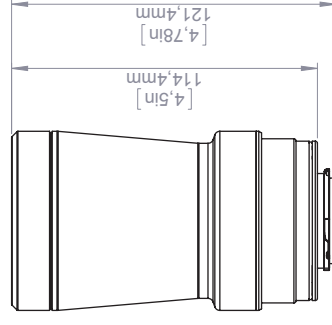
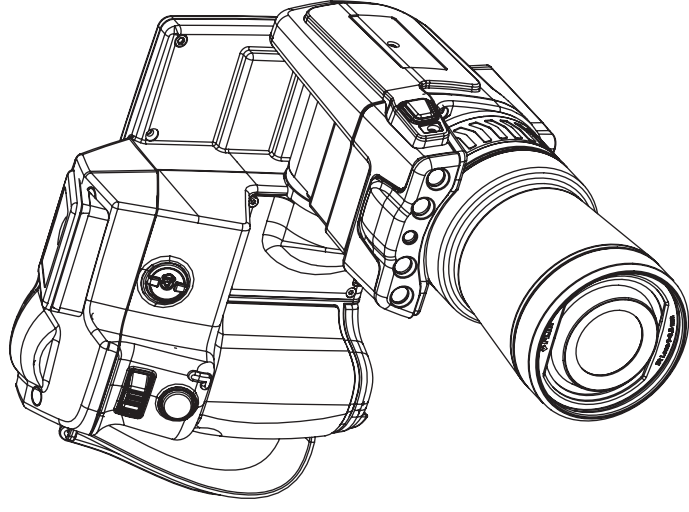
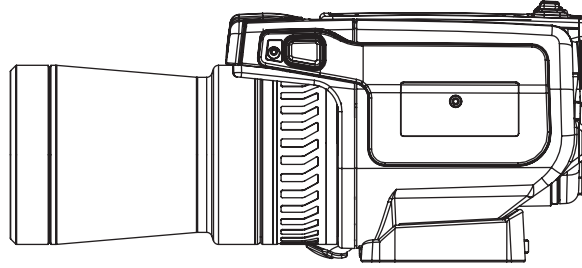
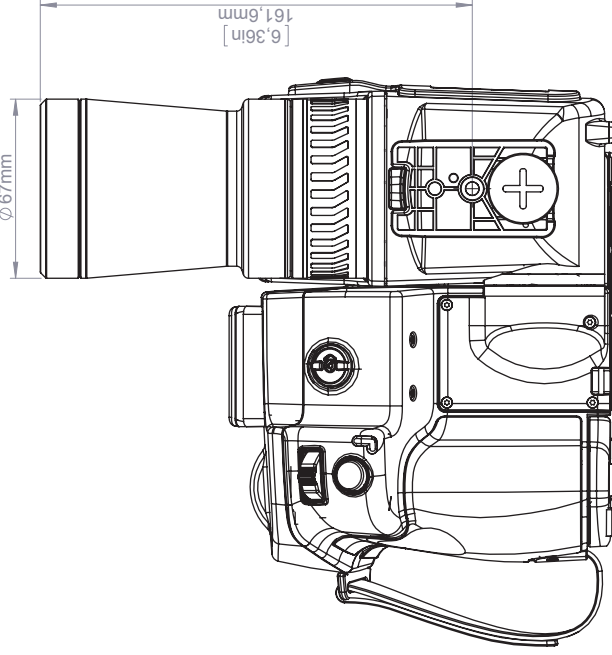
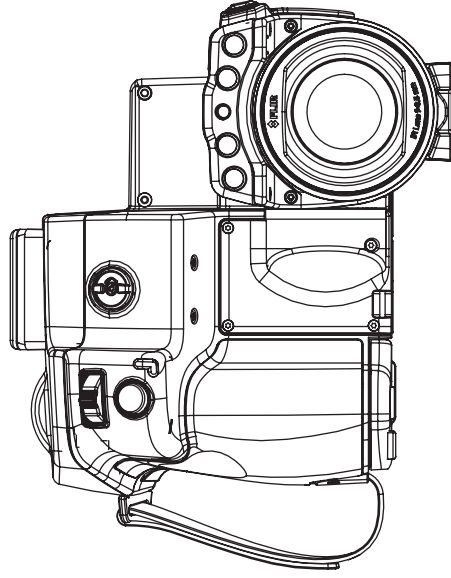
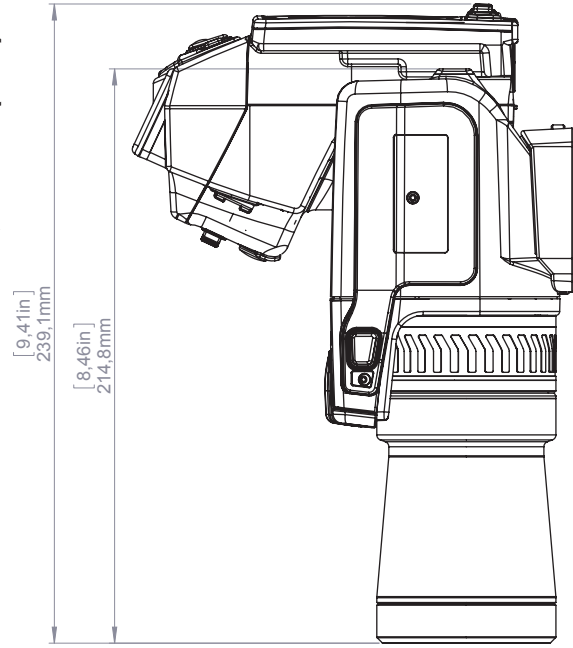

For additional dimensions see page 1

Modified 2014-02-18	Check JOTA	Drawn by R&D Thermography	FLIR®
Denomination <b>Basic dimensions FLIR T6xx mk II</b>			Size A3
			Sheet 2(9)
			Size T128123
			Drawing No.

# Camera with Lens IR f=13,1 mm (45°)

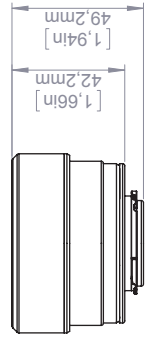
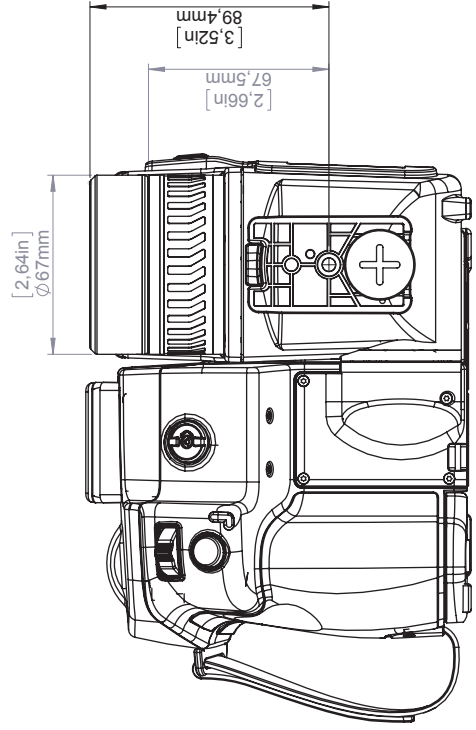
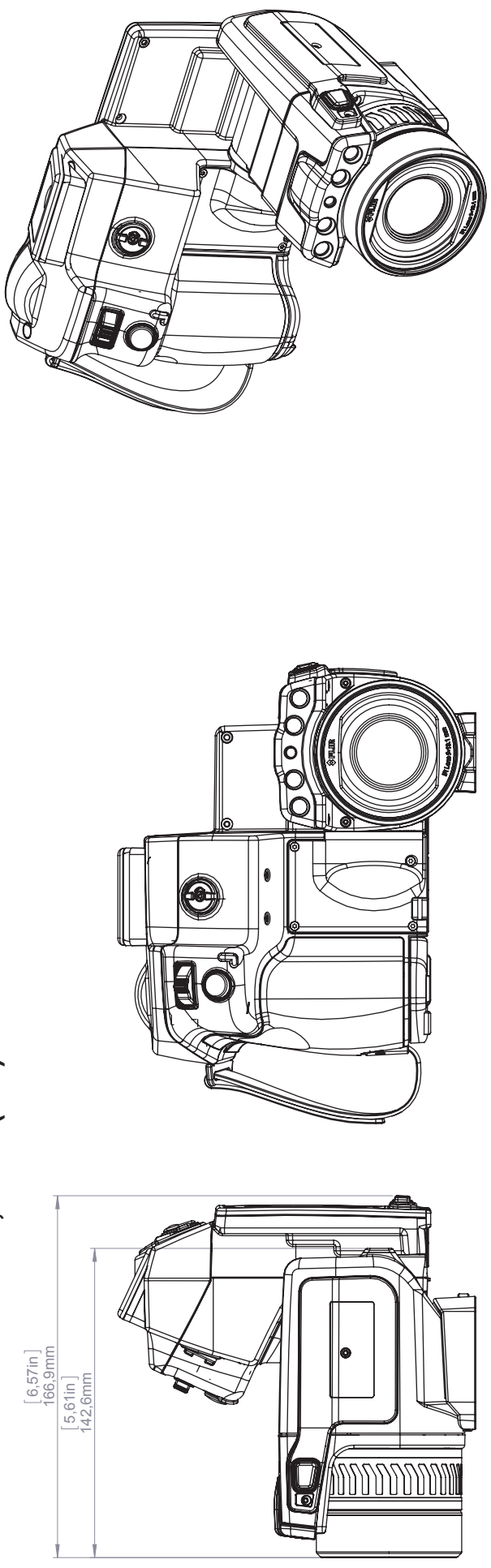

For additional dimensions see page 1

Modified 2014-02-18 Denomination	Check JOTA	Drawn by R&D Thermography	Size A3	Sheet 3(9)	Size A
Basic dimensions FLIR T6xx mk II			Scale 1:2	Drawing No. T128123	

© 2012, FLIR Systems, Inc. All rights reserved worldwide. No part of this drawing may be reproduced, stored in a retrieval system, or transmitted in any form, or by any means, electronic, mechanical, photocopying, recording, or otherwise, without written permission from FLIR Systems, Inc. Specifications subject to change without further notice. Dimensional data is based on nominal values. Products may be subject to regional market considerations. License procedures may apply. Product may be subject to US Export Regulations. Please refer to exportquestions@flir.com with any questions. Diversion contrary to US law is prohibited.

# Camera with Lens IR f=24,6 mm (25°)

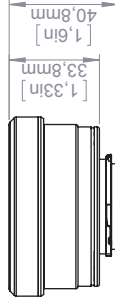
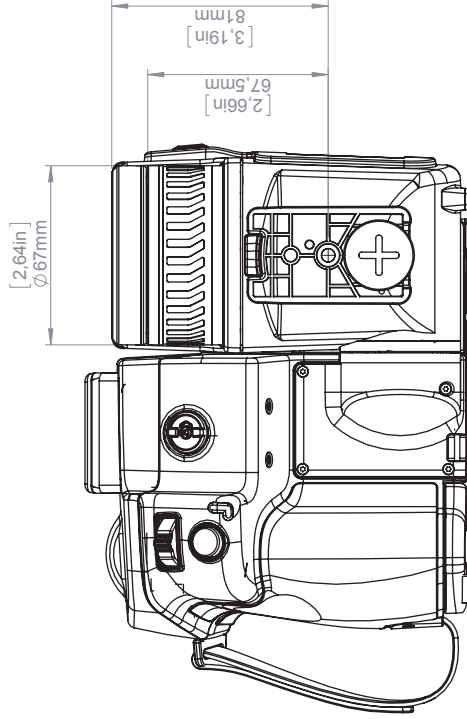
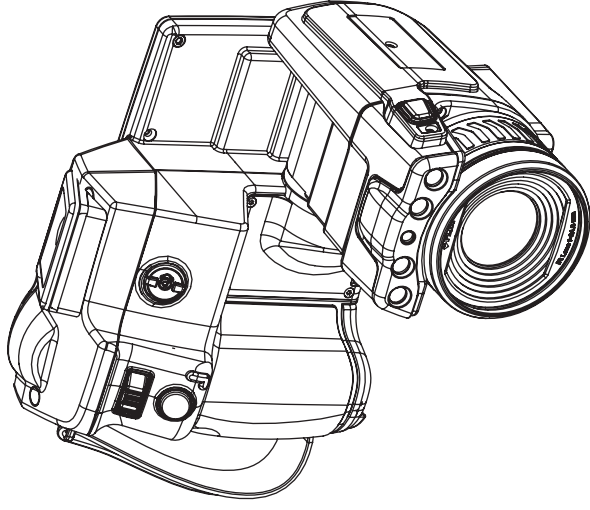
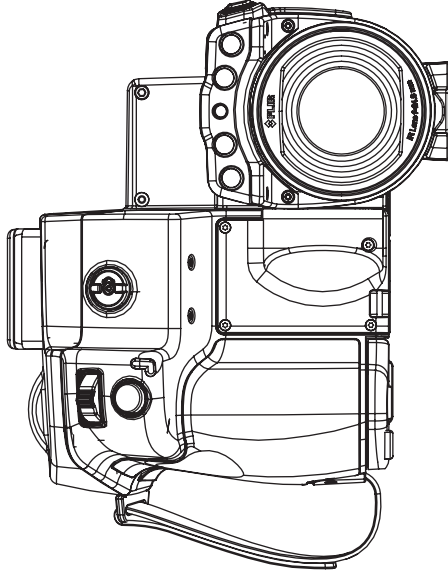
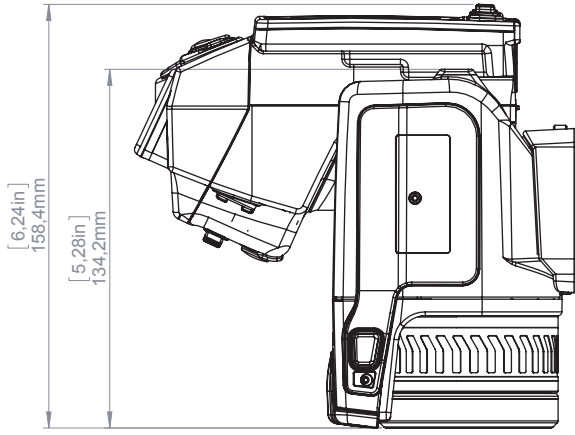

For additional dimensions see page 1

Modified 2014-02-18 Denomination	Check JOTA	Drawn by R&D Thermography	Size A3	Sheet 4(9)	Size A
Basic dimensions FLIR T6xx mk II			Scale 1:2	Drawing No. T128123	



# Camera with Lens IR f=41,3 mm (15°)

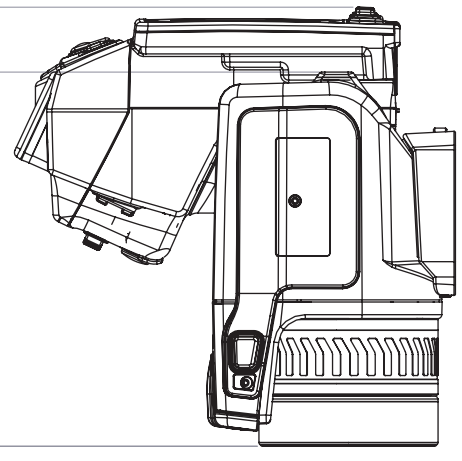
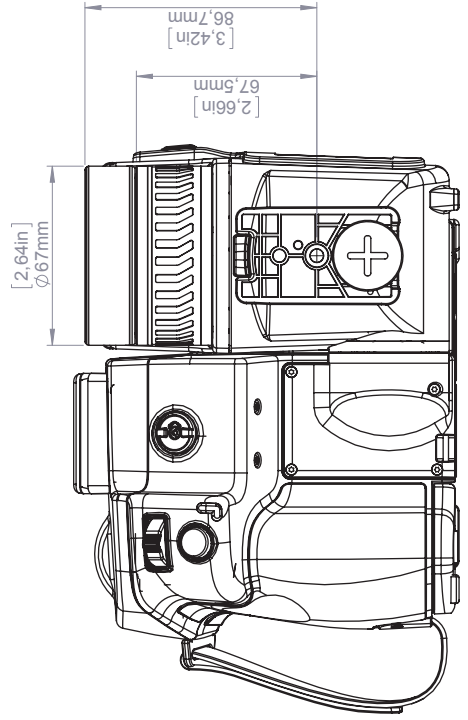
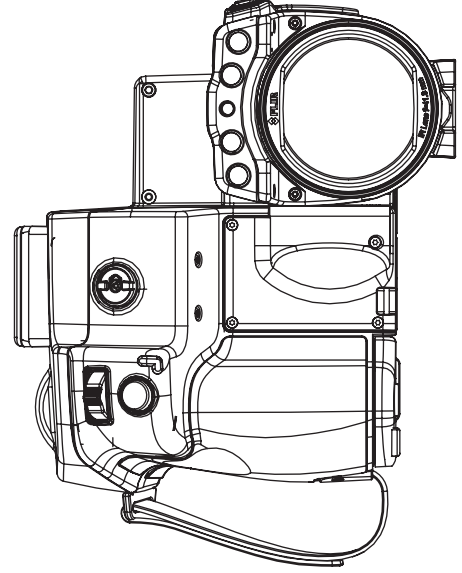
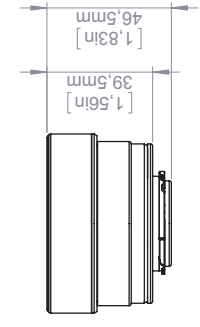
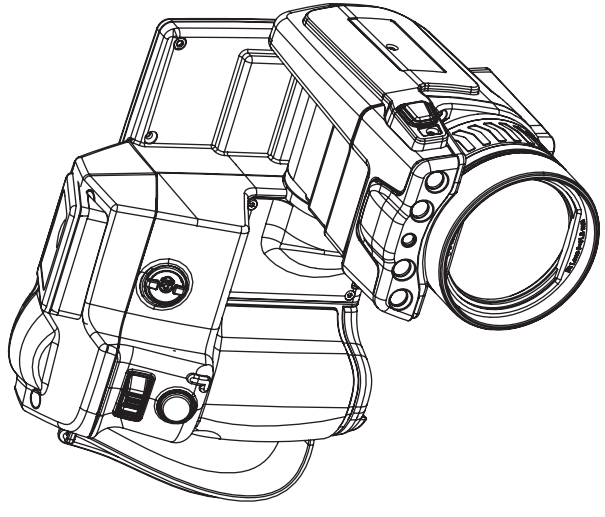

[6.47in]  
164.2mm  
[5.51in]  
139.9mm

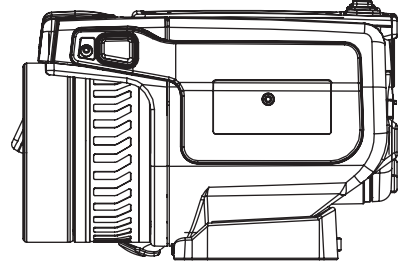

For additional dimensions see page 1			
Modified 2014-02-18 Denomination	Check JOTA	Drawn by R&D Thermography	FLIR®
Basic dimensions FLIR T6xx mk II			Sheet 5(9)
Size A3			Size A
Drawing No. T128123			Scale 1:2

© 2012, FLIR Systems, Inc. All rights reserved worldwide. No part of this drawing may be reproduced, stored in a retrieval system, or transmitted in any form, or by any means, electronic, mechanical, photocopying, recording, or otherwise, without written permission from FLIR Systems, Inc. Specifications subject to change without further notice. Dimensional data is based on nominal values. Products may be subject to regional market considerations. License procedures may apply. Product may be subject to US Export Regulations. Please refer to exportquestions@flir.com with any questions. Diversion contrary to US law is prohibited.

# Camera with Lens IR f=88,9 mm (7°) incl support

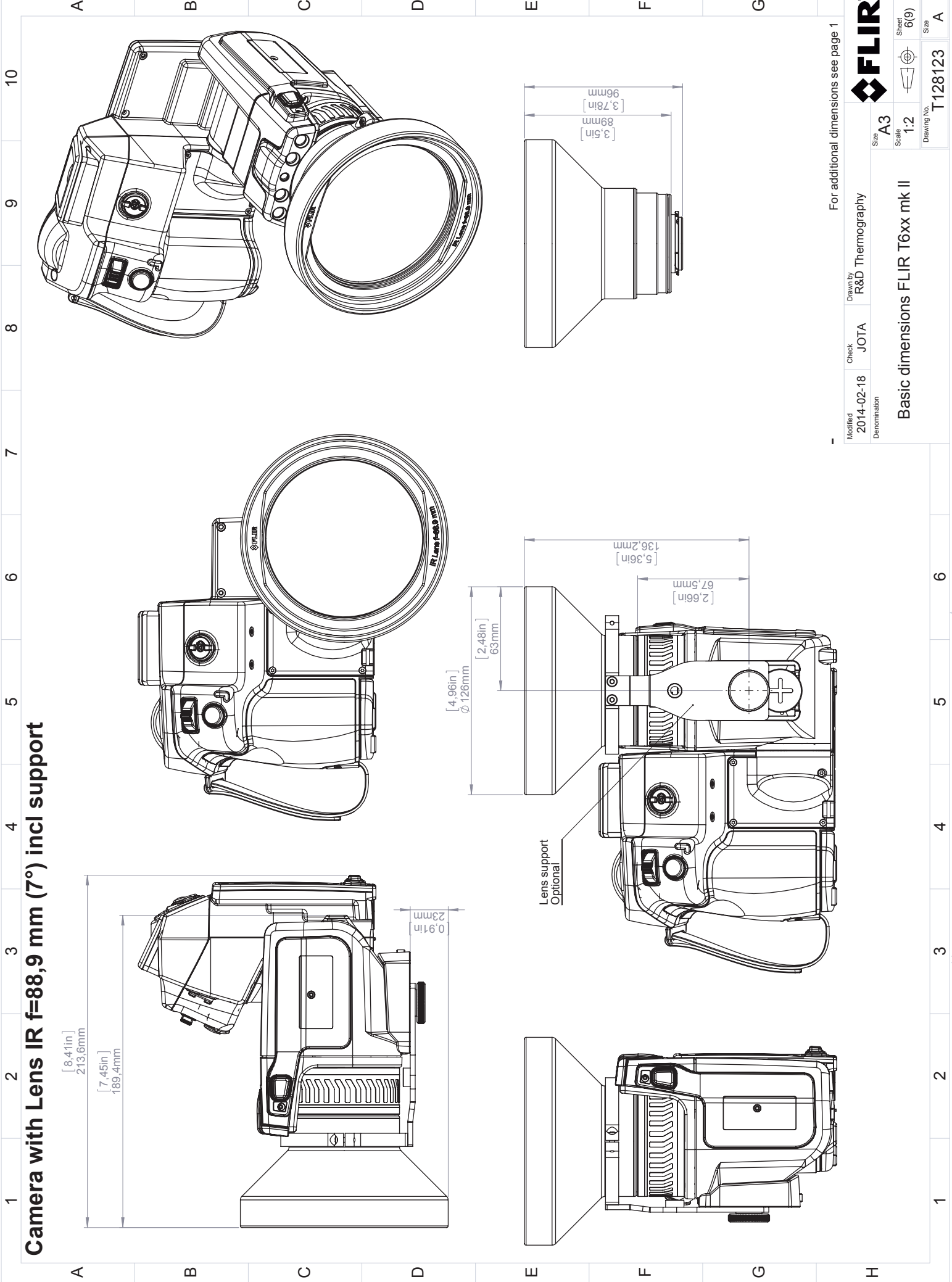

© 2012, FLIR Systems, Inc. All rights reserved worldwide. No part of this drawing may be reproduced, stored in a retrieval system, or transmitted in any form, or by any means, electronic, mechanical, photocopying, recording, or otherwise, without written permission from FLIR Systems, Inc. Specifications subject to change without further notice. Dimensional data is based on nominal values. Products may be subject to regional market considerations. License procedures may apply. Product may be subject to US Export Regulations. Please refer to exportquestions@flir.com with any questions. Diversion contrary to US law is prohibited.

Modified 2014-02-18 Denomination	Check JOTA	Drawn by R&D Thermography	For additional dimensions see page 1
Size A3		Sheet 6(9)	Size A
Scale 1:2		Drawing No. T128123	
Basic dimensions FLIR T6xx mk II			



# Camera with Close-up lens 1,5X (25 µm)

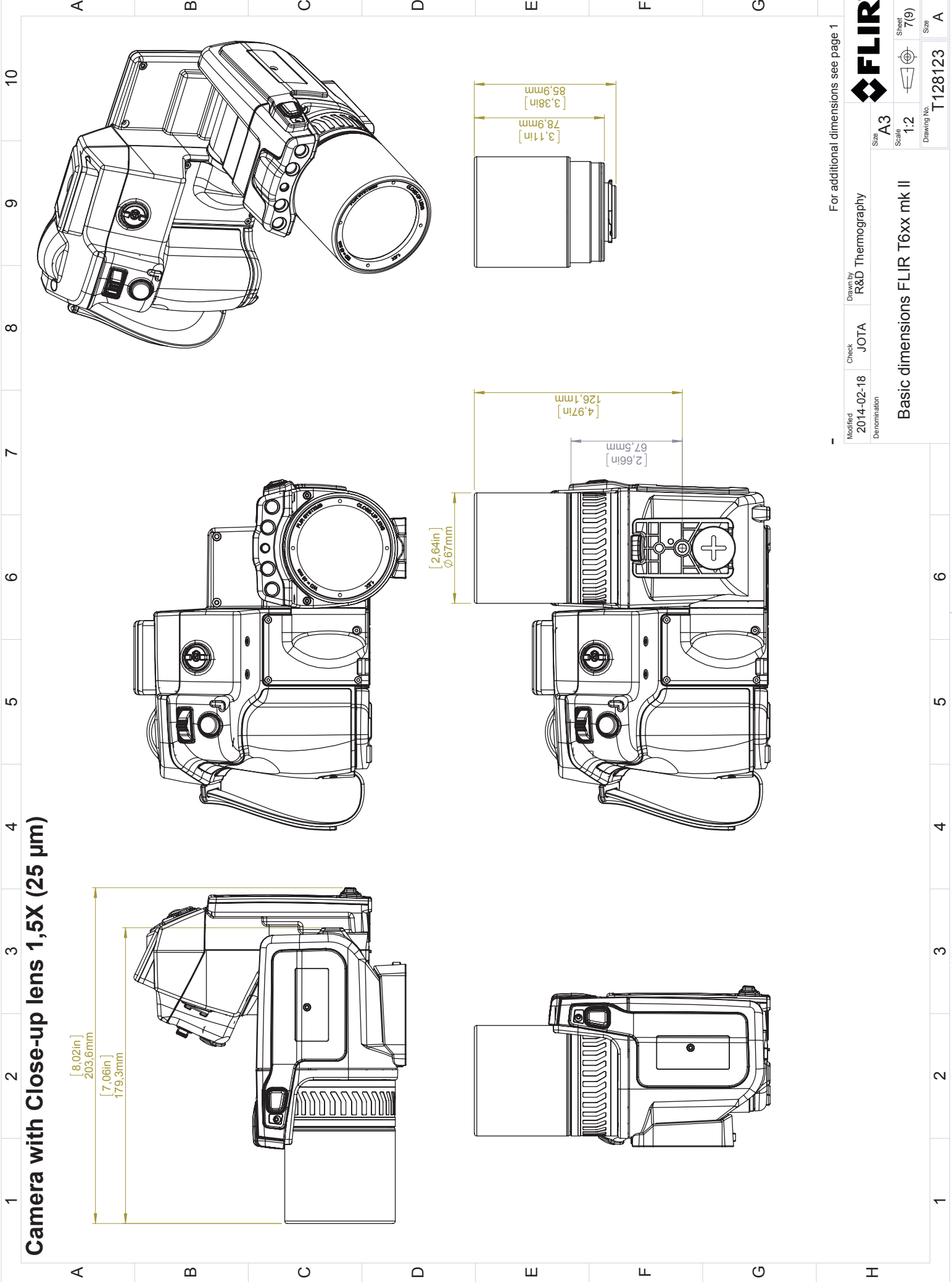

© 2012, FLIR Systems, Inc. All rights reserved worldwide. No part of this drawing may be reproduced, stored in a retrieval system, or transmitted in any form, or by any means, electronic, mechanical, photocopying, recording, or otherwise, without written permission from FLIR Systems, Inc. Specifications subject to change without further notice. Dimensional data is based on nominal values. Products may be subject to regional market considerations. License procedures may apply. Product may be subject to US Export Regulations. Please refer to exportquestions@flir.com with any questions. Diversion contrary to US law is prohibited.

For additional dimensions see page 1

Modified	2014-02-18	Check	JOTA	Drawn by	R&D Thermography	Size	A3
Denomination						Scale	1:2
						Sheet	7(9)
						Drawing No.	T128123
						Size	A

Basic dimensions FLIR T6xx mk II

# Camera with Close-up lens 2,9X (50 μm)

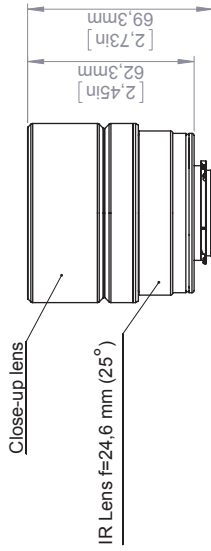
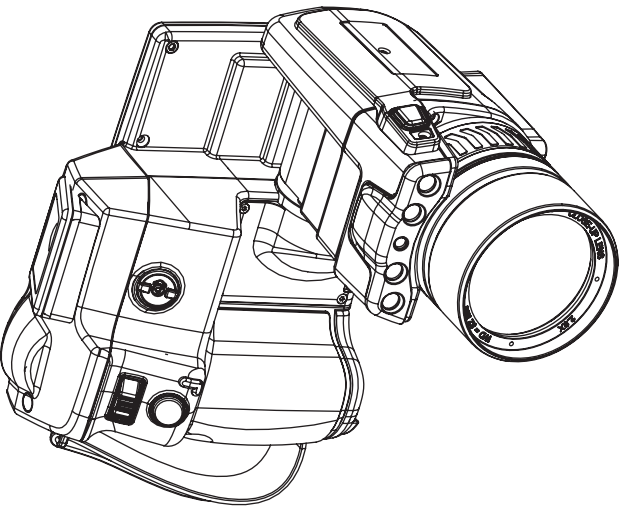
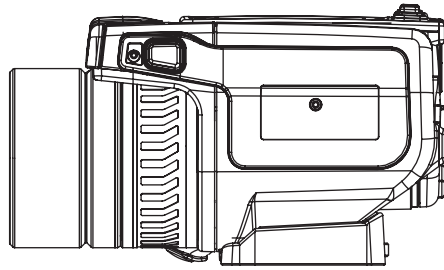
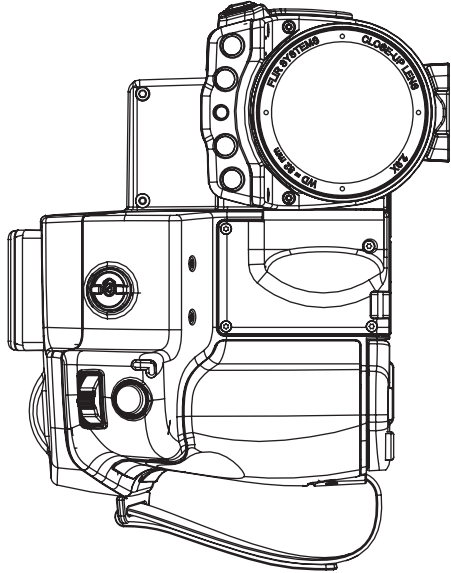
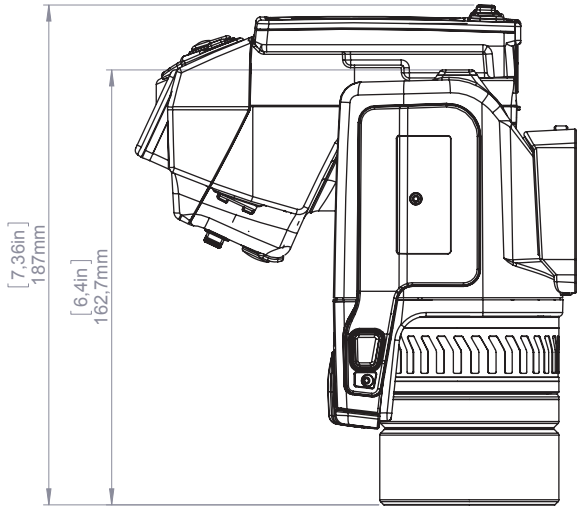

Close-up lens

IR Lens f=24,6 mm (25°)

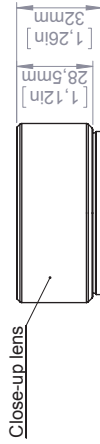

Close-up lens

For additional dimensions see page 1

Modified 2014-02-18  
2014-02-18  
Denomination

Check JOTA

Drawn by R&D Thermography

Size A3  
Scale 1:2  
Sheet 8(9)  
Drawing No. T128123



Basic dimensions FLIR T6xx mk II

Size A  
Drawing No. T128123

# Camera with Close-up lens 5,8X (100 μm)

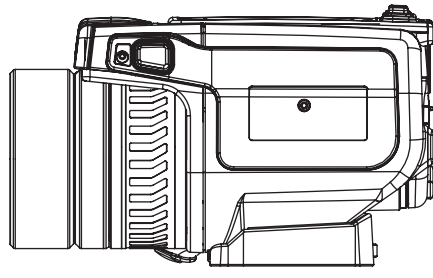
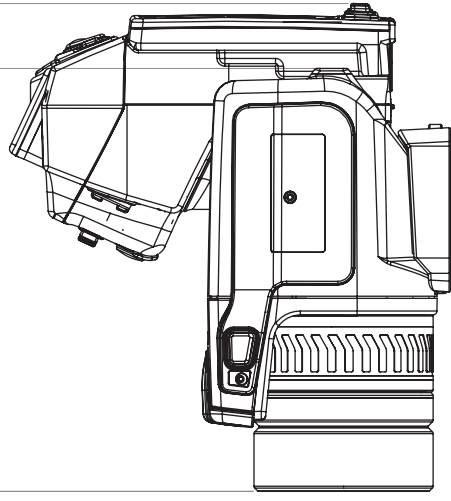
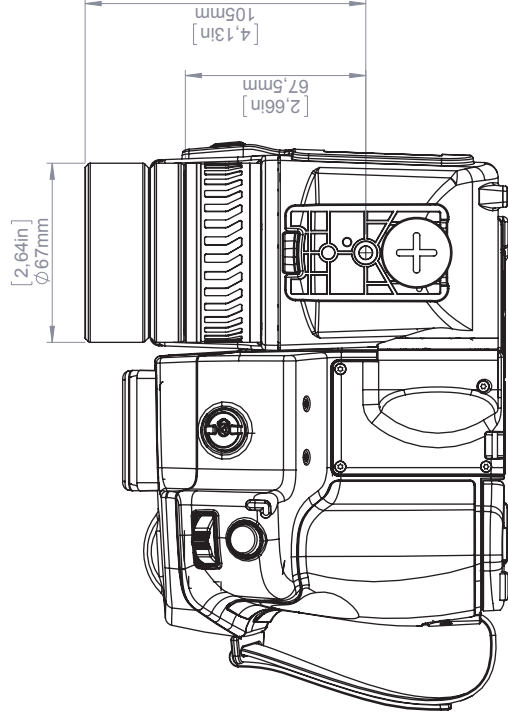
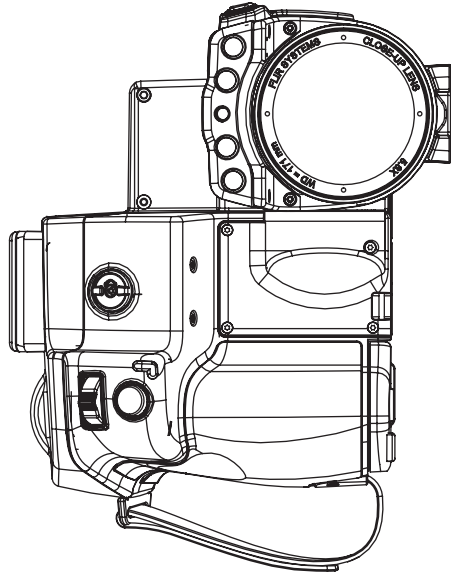
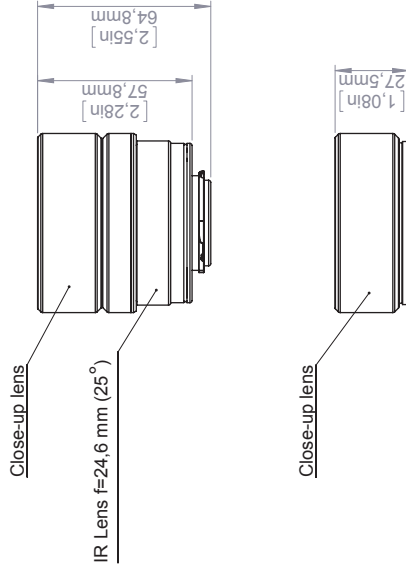
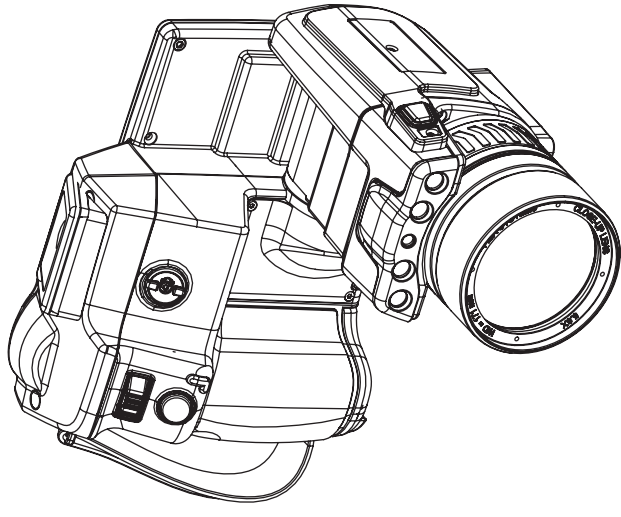

Modified	Check	Drawn by	For additional dimensions see page 1
2014-02-18	JOTA	R&D Thermography	
Denomination			
Basic dimensions FLIR T6xx mk II			
Size	Scale	Sheet	Size
A3	1:2	9(9)	A
Drawing No.	T128123		



[See next page]



January 19, 2018 Täby, Sweden

AQ320250

**CE Declaration of Conformity – EU Declaration of Conformity**

Product: FLIR T6XX -series  
Name and address of the manufacturer:  
FLIR Systems AB  
PO Box 7376  
SE-187 15 Täby, Sweden

This declaration of conformity is issued under the sole responsibility of the manufacturer.  
The object of the declaration: FLIR T6XX -series (Product Model Name FLIR-T5590).  
The object of the declaration described above is in conformity with the relevant Union harmonisation legislation:

**Directives:**

Directive	2012/19/EU	Waste electrical and electric equipment
Directive	1999/519/EC	Limitation of exposure to electromagnetic fields (SAR)
Directive	2011/65/EU	RoHS and 2015/830/EU (Phtalates)
Directive	2014/53/EU	Radio Equipment Directive (RED)

**Standards:**

Emission:	EN 61000-6-3:2007	EMC – Generic standards
Immunity:	EN 61000-6-2:2005	Electromagnetic Compability Generic
	EN 301489-1:2008 v1.8.0	ERM – EMC for radio equipment
	EN 301489-17:2009 v2.1.1	ERM – EMC Wideband data
Laser:	EN 60825-1	Safety of laser products
Radio:	ETSI EN 300 328 v2.1.1	Harmonized EN covering essential requirements of the R&TTE Directive
	ETSI EN 301 893 v.2.1.1	5GHz WLAN
	EN 303 413 v1.1.0	Radio Spectrum Efficiency (gps)
SAR:	EN 50360:2001/A1:2012	Human exposure (300 MHz – 3 GHz)
	EN 50566:2013/AC:2014	Handheld general public (30 MHz – 6 GHz)
Safety:	IEC 60950-1:2005+A1:2009+	Information technology equipment
	EN 60950-1:2006+A11:2009+A1:2010	
RoHS	EN 50581:2012	Technical documentation

**FLIR Systems AB**  
Quality Assurance

Lea Dabiri  
Quality Manager

## 26.1 Camera housing, cables, and other items

### 26.1.1 Liquids

Use one of these liquids:

- Warm water
- A weak detergent solution

### 26.1.2 Equipment

A soft cloth

### 26.1.3 Procedure

Follow this procedure:

1. Soak the cloth in the liquid.
2. Twist the cloth to remove excess liquid.
3. Clean the part with the cloth.

	<b>CAUTION</b>
Do not apply solvents or similar liquids to the camera, the cables, or other items. This can cause damage.	

## 26.2 Infrared lens

### 26.2.1 Liquids

Use one of these liquids:

- A commercial lens cleaning liquid with more than 30% isopropyl alcohol.
- 96% ethyl alcohol (C<sub>2</sub>H<sub>5</sub>OH).

### 26.2.2 Equipment

Cotton wool

	<b>CAUTION</b>
If you use a lens cleaning cloth it must be dry. Do not use a lens cleaning cloth with the liquids that are given in section 26.2.1 above. These liquids can cause material on the lens cleaning cloth to become loose. This material can have an unwanted effect on the surface of the lens.	

### 26.2.3 Procedure

Follow this procedure:

1. Soak the cotton wool in the liquid.
2. Twist the cotton wool to remove excess liquid.
3. Clean the lens one time only and discard the cotton wool.

	<b>WARNING</b>
Make sure that you read all applicable MSDS (Material Safety Data Sheets) and warning labels on containers before you use a liquid: the liquids can be dangerous.	

	<b>CAUTION</b>
<ul style="list-style-type: none"> <li>• Be careful when you clean the infrared lens. The lens has a delicate anti-reflective coating.</li> <li>• Do not clean the infrared lens too vigorously. This can damage the anti-reflective coating.</li> </ul>	

---

## 26.3 Infrared detector

### 26.3.1 General

Even small amounts of dust on the infrared detector can result in major blemishes in the image. To remove any dust from the detector, follow the procedure below.

#### Note

- This section only applies to cameras where removing the lens exposes the infrared detector.
- In some cases the dust cannot be removed by following this procedure: the infrared detector must be cleaned mechanically. This mechanical cleaning must be carried out by an authorized service partner.



#### CAUTION

In Step 2 below, do not use pressurized air from pneumatic air circuits in a workshop, etc., as this air usually contains oil mist to lubricate pneumatic tools.

### 26.3.2 Procedure

Follow this procedure:

1. Remove the lens from the camera.
2. Use pressurized air from a compressed air canister to blow off the dust.

## 27.1 Moisture & water damage

### 27.1.1 General

It is often possible to detect moisture and water damage in a house by using an infrared camera. This is partly because the damaged area has a different heat conduction property and partly because it has a different thermal capacity to store heat than the surrounding material.

Many factors can come into play as to how moisture or water damage will appear in an infrared image.

For example, heating and cooling of these parts takes place at different rates depending on the material and the time of day. For this reason, it is important that other methods are used as well to check for moisture or water damage.

### 27.1.2 Figure

The image below shows extensive water damage on an external wall where the water has penetrated the outer facing because of an incorrectly installed window ledge.

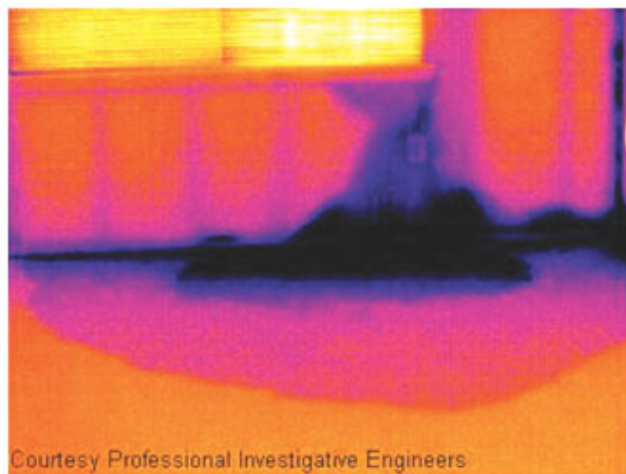

## 27.2 Faulty contact in socket

### 27.2.1 General

Depending on the type of connection a socket has, an improperly connected wire can result in local temperature increase. This temperature increase is caused by the reduced contact area between the connection point of the incoming wire and the socket, and can result in an electrical fire.

A socket's construction may differ dramatically from one manufacturer to another. For this reason, different faults in a socket can lead to the same typical appearance in an infrared image.

Local temperature increase can also result from improper contact between wire and socket, or from difference in load.

### 27.2.2 Figure

The image below shows a connection of a cable to a socket where improper contact in the connection has resulted in local temperature increase.

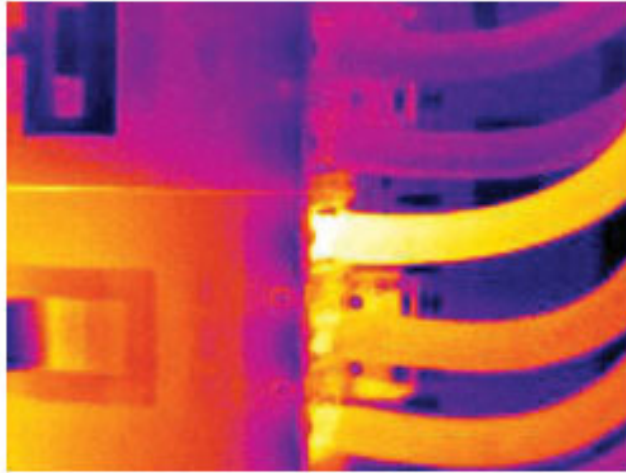

## 27.3 Oxidized socket

### 27.3.1 General

Depending on the type of socket and the environment in which the socket is installed, oxides may occur on the socket's contact surfaces. These oxides can lead to locally increased resistance when the socket is loaded, which can be seen in an infrared image as local temperature increase.

A socket's construction may differ dramatically from one manufacturer to another. For this reason, different faults in a socket can lead to the same typical appearance in an infrared image.

Local temperature increase can also result from improper contact between a wire and socket, or from difference in load.

### 27.3.2 Figure

The image below shows a series of fuses where one fuse has a raised temperature on the contact surfaces against the fuse holder. Because of the fuse holder's blank metal, the temperature increase is not visible there, while it is visible on the fuse's ceramic material.

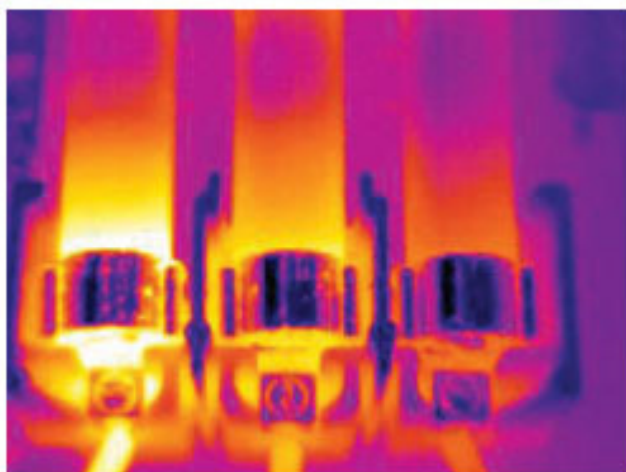

---

## 27.4 Insulation deficiencies

### 27.4.1 General

Insulation deficiencies may result from insulation losing volume over the course of time and thereby not entirely filling the cavity in a frame wall.

An infrared camera allows you to see these insulation deficiencies because they either have a different heat conduction property than sections with correctly installed insulation, and/or show the area where air is penetrating the frame of the building.

When you are inspecting a building, the temperature difference between the inside and outside should be at least 10°C (18°F). Studs, water pipes, concrete columns, and similar components may resemble an insulation deficiency in an infrared image. Minor differences may also occur naturally.

### 27.4.2 Figure

In the image below, insulation in the roof framing is lacking. Due to the absence of insulation, air has forced its way into the roof structure, which thus takes on a different characteristic appearance in the infrared image.

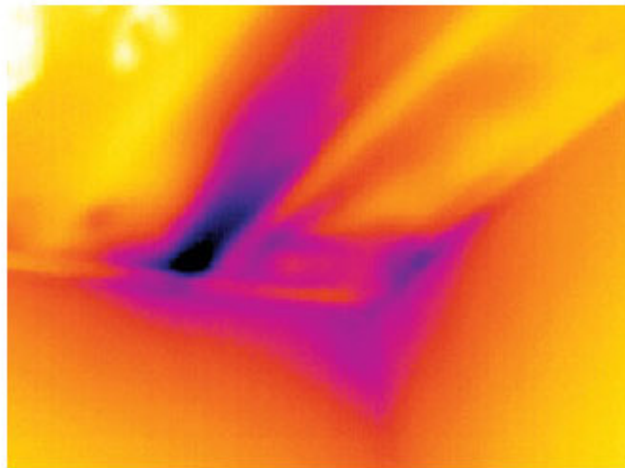

## 27.5 Draft

### 27.5.1 General

Draft can be found under baseboards, around door and window casings, and above ceiling trim. This type of draft is often possible to see with an infrared camera, as a cooler airstream cools down the surrounding surface.

When you are investigating draft in a house, there should be sub-atmospheric pressure in the house. Close all doors, windows, and ventilation ducts, and allow the kitchen fan to run for a while before you take the infrared images.

An infrared image of draft often shows a typical stream pattern. You can see this stream pattern clearly in the picture below.

Also keep in mind that drafts can be concealed by heat from floor heating circuits.

### 27.5.2 Figure

The image below shows a ceiling hatch where faulty installation has resulted in a strong draft.

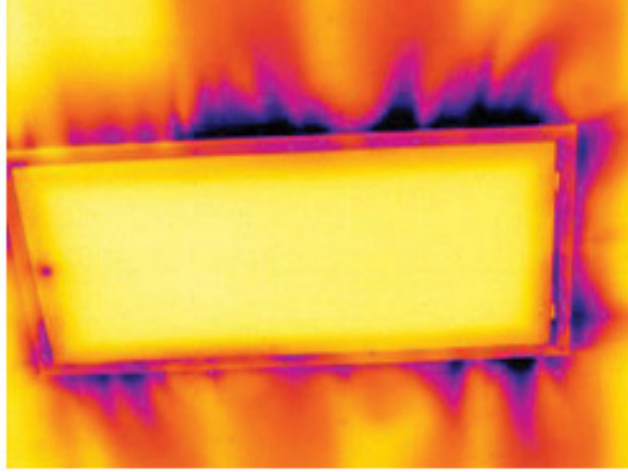



## 28.1 Introduction

An infrared camera measures and images the emitted infrared radiation from an object. The fact that radiation is a function of object surface temperature makes it possible for the camera to calculate and display this temperature.

However, the radiation measured by the camera does not only depend on the temperature of the object but is also a function of the emissivity. Radiation also originates from the surroundings and is reflected in the object. The radiation from the object and the reflected radiation will also be influenced by the absorption of the atmosphere.

To measure temperature accurately, it is therefore necessary to compensate for the effects of a number of different radiation sources. This is done on-line automatically by the camera. The following object parameters must, however, be supplied for the camera:

- The emissivity of the object
- The reflected apparent temperature
- The distance between the object and the camera
- The relative humidity
- Temperature of the atmosphere

## 28.2 Emissivity

The most important object parameter to set correctly is the emissivity which, in short, is a measure of how much radiation is emitted from the object, compared to that from a perfect blackbody of the same temperature.

Normally, object materials and surface treatments exhibit emissivity ranging from approximately 0.1 to 0.95. A highly polished (mirror) surface falls below 0.1, while an oxidized or painted surface has a higher emissivity. Oil-based paint, regardless of color in the visible spectrum, has an emissivity over 0.9 in the infrared. Human skin exhibits an emissivity 0.97 to 0.98.

Non-oxidized metals represent an extreme case of perfect opacity and high reflexivity, which does not vary greatly with wavelength. Consequently, the emissivity of metals is low – only increasing with temperature. For non-metals, emissivity tends to be high, and decreases with temperature.

### 28.2.1 Finding the emissivity of a sample

#### 28.2.1.1 *Step 1: Determining reflected apparent temperature*

Use one of the following two methods to determine reflected apparent temperature:

## 28.2.1.1.1 Method 1: Direct method

Follow this procedure:

1. Look for possible reflection sources, considering that the incident angle = reflection angle ( $a = b$ ).

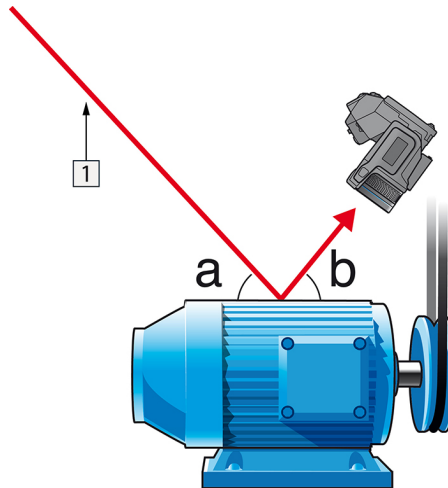

Figure 28.1 1 = Reflection source

2. If the reflection source is a spot source, modify the source by obstructing it using a piece of cardboard.

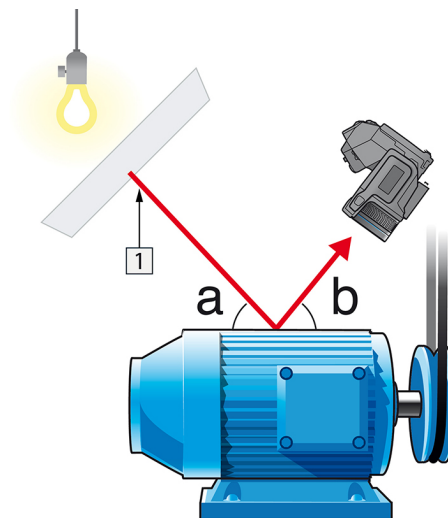

Figure 28.2 1 = Reflection source

3. Measure the radiation intensity (= apparent temperature) from the reflection source using the following settings:

- Emissivity: 1.0
- $D_{obj}$ : 0

You can measure the radiation intensity using one of the following two methods:

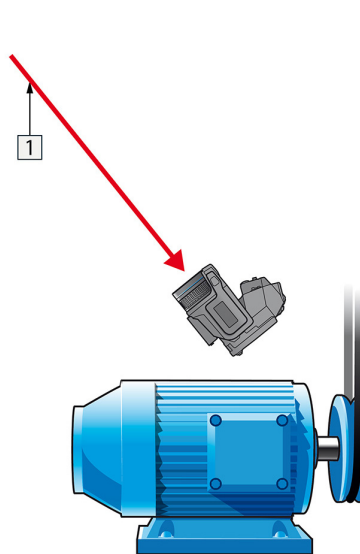

Figure 28.3 1 = Reflection source

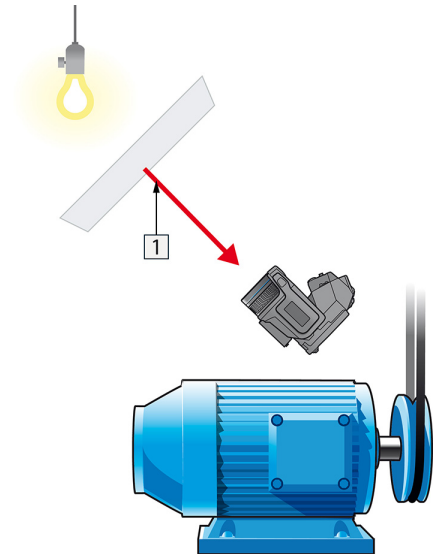

Figure 28.4 1 = Reflection source

You can not use a thermocouple to measure reflected apparent temperature, because a thermocouple measures *temperature*, but apparent temperature is *radiation intensity*.

#### 28.2.1.1.2 Method 2: Reflector method

Follow this procedure:

1. Crumble up a large piece of aluminum foil.
2. Uncrumble the aluminum foil and attach it to a piece of cardboard of the same size.
3. Put the piece of cardboard in front of the object you want to measure. Make sure that the side with aluminum foil points to the camera.
4. Set the emissivity to 1.0.

5. Measure the apparent temperature of the aluminum foil and write it down. The foil is considered a perfect reflector, so its apparent temperature equals the reflected apparent temperature from the surroundings.

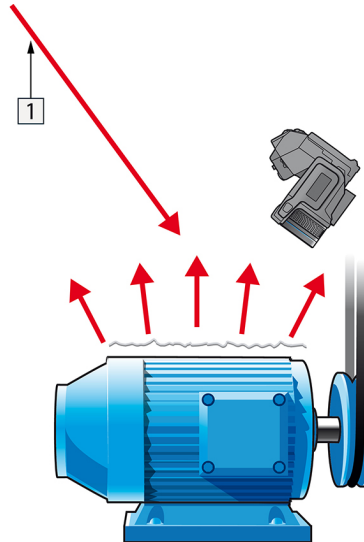

**Figure 28.5** Measuring the apparent temperature of the aluminum foil.

### 28.2.1.2 Step 2: Determining the emissivity

Follow this procedure:

1. Select a place to put the sample.
2. Determine and set reflected apparent temperature according to the previous procedure.
3. Put a piece of electrical tape with known high emissivity on the sample.
4. Heat the sample at least 20 K above room temperature. Heating must be reasonably even.
5. Focus and auto-adjust the camera, and freeze the image.
6. Adjust *Level* and *Span* for best image brightness and contrast.
7. Set emissivity to that of the tape (usually 0.97).
8. Measure the temperature of the tape using one of the following measurement functions:
  - *Isotherm* (helps you to determine both the temperature and how evenly you have heated the sample)
  - *Spot* (simpler)
  - *Box Avg* (good for surfaces with varying emissivity).
9. Write down the temperature.
10. Move your measurement function to the sample surface.
11. Change the emissivity setting until you read the same temperature as your previous measurement.
12. Write down the emissivity.

#### Note

- Avoid forced convection
- Look for a thermally stable surrounding that will not generate spot reflections
- Use high quality tape that you know is not transparent, and has a high emissivity you are certain of
- This method assumes that the temperature of your tape and the sample surface are the same. If they are not, your emissivity measurement will be wrong.

### 28.3 Reflected apparent temperature

This parameter is used to compensate for the radiation reflected in the object. If the emissivity is low and the object temperature relatively far from that of the reflected it will be important to set and compensate for the reflected apparent temperature correctly.

### 28.4 Distance

The distance is the distance between the object and the front lens of the camera. This parameter is used to compensate for the following two facts:

- That radiation from the target is absorbed by the atmosphere between the object and the camera.
- That radiation from the atmosphere itself is detected by the camera.

### 28.5 Relative humidity

The camera can also compensate for the fact that the transmittance is also dependent on the relative humidity of the atmosphere. To do this set the relative humidity to the correct value. For short distances and normal humidity the relative humidity can normally be left at a default value of 50%.

### 28.6 Other parameters

In addition, some cameras and analysis programs from FLIR Systems allow you to compensate for the following parameters:

- Atmospheric temperature – *i.e.* the temperature of the atmosphere between the camera and the target
- External optics temperature – *i.e.* the temperature of any external lenses or windows used in front of the camera
- External optics transmittance – *i.e.* the transmission of any external lenses or windows used in front of the camera

FLIR Systems was established in 1978 to pioneer the development of high-performance infrared imaging systems, and is the world leader in the design, manufacture, and marketing of thermal imaging systems for a wide variety of commercial, industrial, and government applications. Today, FLIR Systems embraces five major companies with outstanding achievements in infrared technology since 1958—the Swedish AGEMA Infrared Systems (formerly AGA Infrared Systems), the three United States companies In-digo Systems, FSI, and Inframetrics, and the French company Cedic.

Since 2007, FLIR Systems has acquired several companies with world-leading expertise in sensor technologies:

- Exttech Instruments (2007)
- Ifara Tecnologías (2008)
- Salvador Imaging (2009)
- OmniTech Partners (2009)
- Directed Perception (2009)
- Raymarine (2010)
- ICx Technologies (2010)
- TackTick Marine Digital Instruments (2011)
- Aerius Photonics (2011)
- Lorex Technology (2012)
- Traficon (2012)
- MARSS (2013)
- DigitalOptics micro-optics business (2013)
- DVTEL (2015)
- Point Grey Research (2016)
- Prox Dynamics (2016)

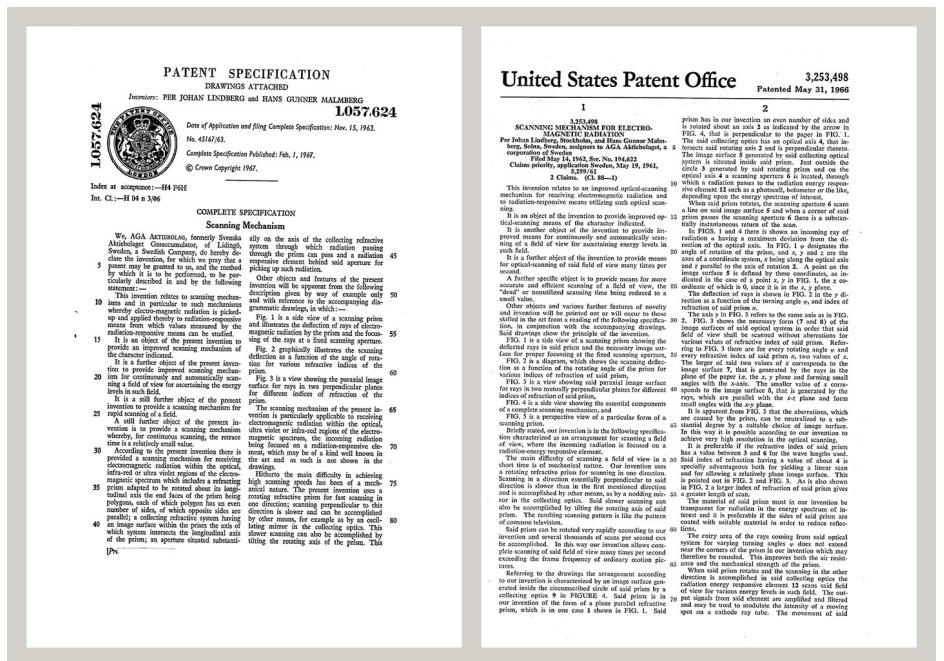

Figure 29.1 Patent documents from the early 1960s

FLIR Systems has three manufacturing plants in the United States (Portland, OR, Boston, MA, Santa Barbara, CA) and one in Sweden (Stockholm). Since 2007 there is also a manufacturing plant in Tallinn, Estonia. Direct sales offices in Belgium, Brazil, China, France, Germany, Great Britain, Hong Kong, Italy, Japan, Korea, Sweden, and the USA—together with a worldwide network of agents and distributors—support our international customer base.

FLIR Systems is at the forefront of innovation in the infrared camera industry. We anticipate market demand by constantly improving our existing cameras and developing new ones. The company has set milestones in product design and development such as the introduction of the first battery-operated portable camera for industrial inspections, and the first uncooled infrared camera, to mention just two innovations.



**Figure 29.2** 1969: Thermovision Model 661. The camera weighed approximately 25 kg (55 lb.), the oscilloscope 20 kg (44 lb.), and the tripod 15 kg (33 lb.). The operator also needed a 220 VAC generator set, and a 10 L (2.6 US gallon) jar with liquid nitrogen. To the left of the oscilloscope the Polaroid attachment (6 kg (13 lb.)) can be seen.



**Figure 29.3** 2015: FLIR One, an accessory to iPhone and Android mobile phones. Weight: 90 g (3.2 oz.).

FLIR Systems manufactures all vital mechanical and electronic components of the camera systems itself. From detector design and manufacturing, to lenses and system electronics, to final testing and calibration, all production steps are carried out and supervised by our own engineers. The in-depth expertise of these infrared specialists ensures the accuracy and reliability of all vital components that are assembled into your infrared camera.

## 29.1 More than just an infrared camera

At FLIR Systems we recognize that our job is to go beyond just producing the best infrared camera systems. We are committed to enabling all users of our infrared camera systems to work more productively by providing them with the most powerful camera–software combination. Especially tailored software for predictive maintenance, R & D, and process monitoring is developed in-house. Most software is available in a wide variety of languages.

We support all our infrared cameras with a wide variety of accessories to adapt your equipment to the most demanding infrared applications.

## 29.2 Sharing our knowledge

Although our cameras are designed to be very user-friendly, there is a lot more to thermography than just knowing how to handle a camera. Therefore, FLIR Systems has founded the Infrared Training Center (ITC), a separate business unit, that provides certified training courses. Attending one of the ITC courses will give you a truly hands-on learning experience.

The staff of the ITC are also there to provide you with any application support you may need in putting infrared theory into practice.

## 29.3 Supporting our customers

FLIR Systems operates a worldwide service network to keep your camera running at all times. If you discover a problem with your camera, local service centers have all the equipment and expertise to solve it within the shortest possible time. Therefore, there is no need to send your camera to the other side of the world or to talk to someone who does not speak your language.







---

**Website**

<http://www.flir.com>

**Customer support**

<http://support.flir.com>

**Copyright**

© 2019, FLIR Systems, Inc. All rights reserved worldwide.

**Disclaimer**

Specifications subject to change without further notice. Models and accessories subject to regional market considerations. License procedures may apply. Products described herein may be subject to US Export Regulations. Please refer to [exportquestions@flir.com](mailto:exportquestions@flir.com) with any questions.

Publ. No.: T559880  
Release: AM  
Commit: 56659  
Head: 56659  
Language: en-US  
Modified: 2019-04-08  
Formatted: 2019-04-08