

SiC Schottky Diode

tentative

$$V_{RRM} = 2 \times 1200 \text{ V}$$

$$I_{FAV} = 12.5 \text{ A}$$

Ultra fast switching
Zero reverse recovery
Phase leg

Part number
DCG10P1200HR

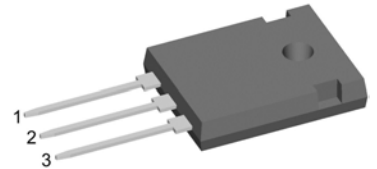

Backside: isolated

E72873

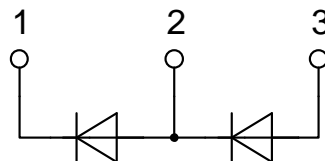
**Features / Advantages:**

- Ultra fast switching
- Zero reverse recovery
- Zero forward recovery
- Temperature independent switching behavior
- Positive temperature coefficient of forward voltage
- $T_{VM} = 175^{\circ}\text{C}$

Applications:

- Solar inverter
- Uninterruptible power supply (UPS)
- Welding equipment
- Switched-mode power supplies
- Medical equipment
- High speed rectifier

Package: ISO247

- Isolation Voltage: 3600 V~
- Industry standard outline
- RoHS compliant
- Epoxy meets UL 94V-0
- Soldering pins for PCB mounting
- Backside: DCB ceramic
- Reduced weight
- Advanced power cycling

Terms & Conditions of Usage

The data contained in this product data sheet is exclusively intended for technically trained staff. The user will have to evaluate the suitability of the product for the intended application and the completeness of the product data with respect to his application. The specifications of our components may not be considered as an assurance of component characteristics. The information in the valid application- and assembly notes must be considered. Should you require product information in excess of the data given in this product data sheet or which concerns the specific application of your product, please contact the sales office, which is responsible for you. Due to technical requirements our product may contain dangerous substances. For information on the types in question please contact the sales office, which is responsible for you.

Should you intend to use the product in aviation, in health or life endangering or life support applications, please notify. For any such application we urgently recommend

- to perform joint risk and quality assessments;

- the conclusion of quality agreements;

- to establish joint measures of an ongoing product survey, and that we may make delivery dependent on the realization of any such measures.

IXYS reserves the right to change limits, test conditions and dimensions.

20180529

SiC Diode (per diode)				Ratings			
Symbol	Definitions	Conditions	min.	typ.	max.		
V_{RSM}	max. non-repetitive reverse blocking voltage				1200	V	
V_{RRM}	max. repetitive reverse blocking voltage				1200	V	
I_R	reverse current	$V_R = V_{RRM}$			30	μA	
					55	μA	
V_F	forward voltage	$I_F = 10 A$			1.5	V	
		$I_F = 20 A$			1.8	V	
			$T_{VJ} = 25^\circ C$				
					2.2	V	
					3.0	V	
I_{FAV}	average forward current	$T_C = 80^\circ C$	rectangular, d = 0.5			12.5	A
		$T_C = 100^\circ C$					$T_{VJ} = 175^\circ C$
I_{F25}	forward current	based on typ. V_{F0} and r_F	$T_C = 25^\circ C$			22	A
I_{F80}			$T_C = 80^\circ C$			17	A
I_{F100}			$T_C = 100^\circ C$			15	A
I_{FSM}	max forward surge current	t = 10 ms, half sine (50 Hz)	$T_{VJ} = 25^\circ C$				A
		$t_p = 10 \mu s$, pulse					
V_{F0}	threshold voltage	} for power loss calculation	$T_{VJ} = 125^\circ C$		0.77	V	
			$T_{VJ} = 175^\circ C$		0.69	V	
r_F	slope resistance		$T_{VJ} = 125^\circ C$		107	$m\Omega$	
			$T_{VJ} = 175^\circ C$		133	$m\Omega$	
Q_C	total capacitive charge	$V_R = 800 V$, $I_F = 10A$ $di/dt = 200 A/\mu s$	$T_{VJ} = 25^\circ C$		52	nC	
C	total capacitance	$V_R = 0 V$	$T_{VJ} = 25^\circ C$, f = 1 MHz			755	pF
		$V_R = 400 V$				45	pF
		$V_R = 800 V$				38	pF
R_{thJC}	thermal resistance junction to case	with heatsink compound; IXYS test setup			1.9	K/W	
R_{thJH}	thermal resistance junction to heatsink		2.2	K/W			

tentative

Package ISO247				Ratings		
Symbol	Definitions	Conditions	min.	typ.	max.	
I_{RMS}	RMS current	per terminal			70	A
T_{stg}	storage temperature		-40		150	°C
T_{op}	operation temperature		-40		150	°C
T_{vJ}	virtual junction temperature		-40		175	°C
Weight				6		g
M_D	mounting torque		0.8		1.2	Nm
F_C	mounting force with clip		40		120	N
$d_{Spp/App}$	creepage distance on surface /	terminal to terminal	2.7			mm
$d_{Spb/Appb}$	striking distance through air	terminal to backside	4.1			mm
V_{ISOL}	isolation voltage	t = 1 second t = 1 minute		3600 3000		V V
		50/60 Hz; RMS; $I_{ISOL} < 1$ mA				

Product Marking

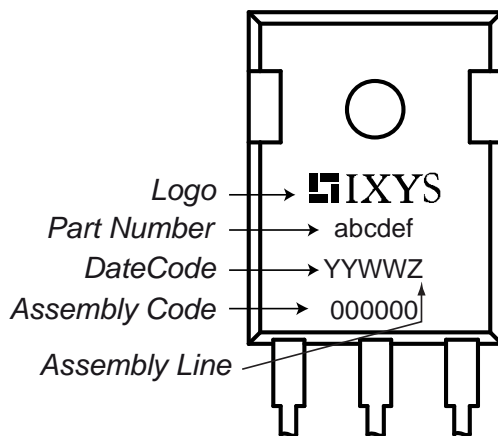

Part description

- D = Diode
- C = SiC
- G = Extreme fast
- 10 = Current Rating [A]
- P = Phase leg
- 1200 = Reverse Voltage [V]
- HR = ISO247 (3)

Ordering	Part Name	Marking on Product	Delivering Mode	Base Qty	Ordering Code
Standard	DCG10P1200HR	DCG10P1200HR	Tube	30	522967

Equivalent Circuits for Simulation *on die level, typical

		$T_{vJ} = 125^{\circ}\text{C}$	$T_{vJ} = 175^{\circ}\text{C}$	
V_0	threshold voltage	0.77	0.68	V
R_0	slope resistance *	107	133	mΩ

IXYS reserves the right to change limits, test conditions and dimensions.

20180529

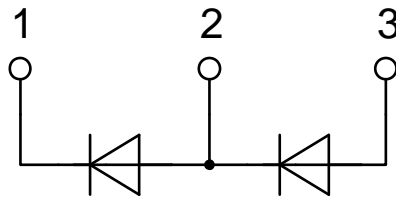
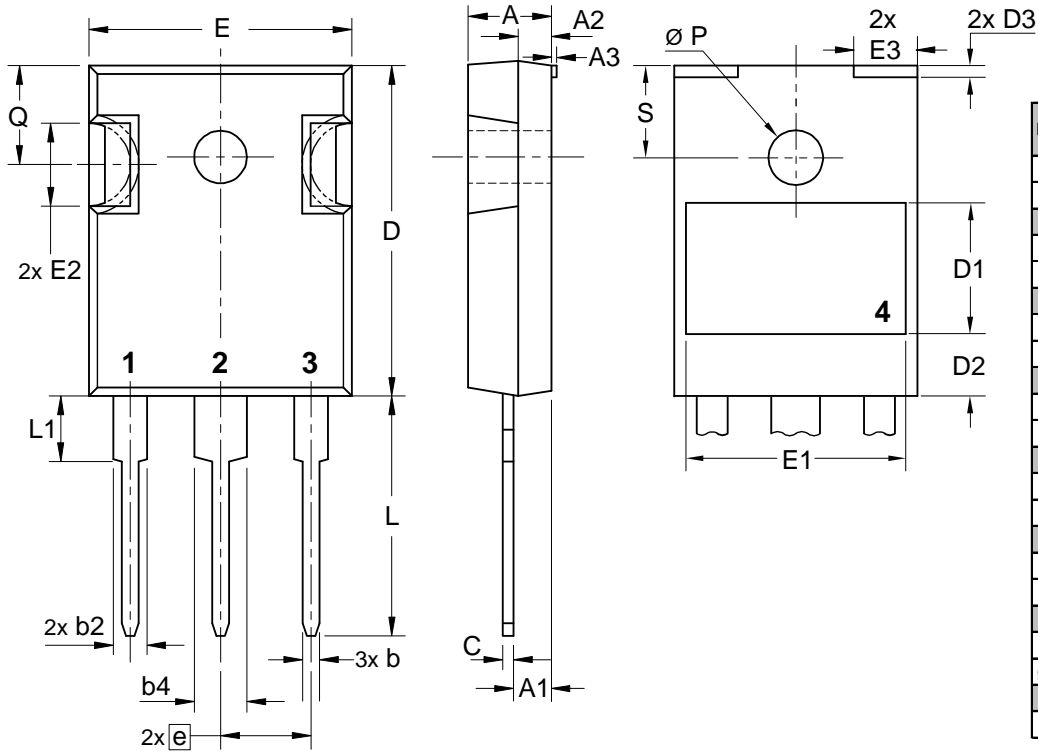

SiC Diode (per leg)

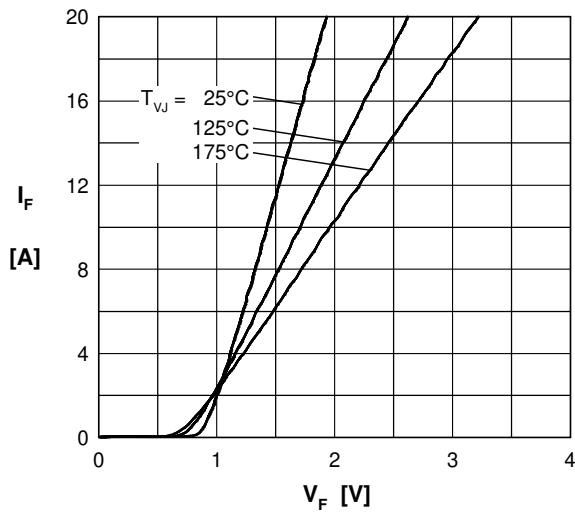

Fig. 1 Typ. forward characteristics.

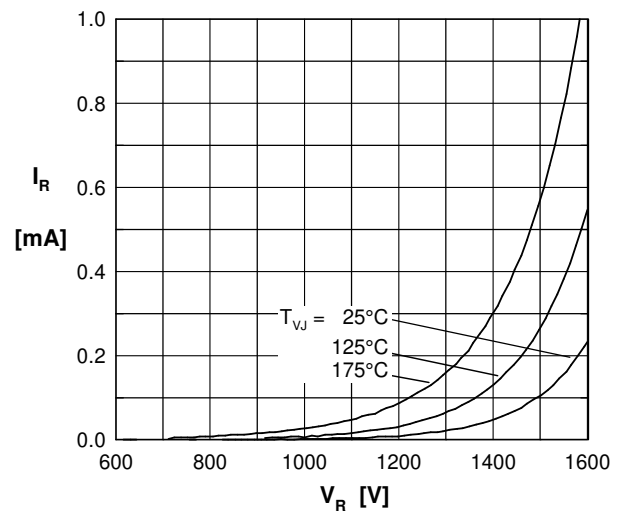

Fig. 2 Typ. reverse characteristics

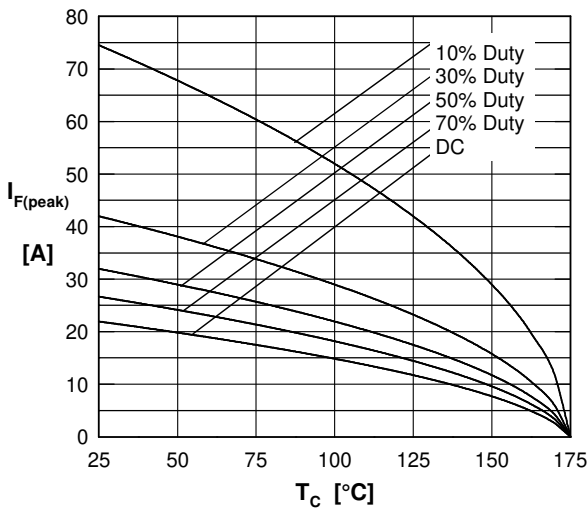

Fig. 3 Typ. current derating

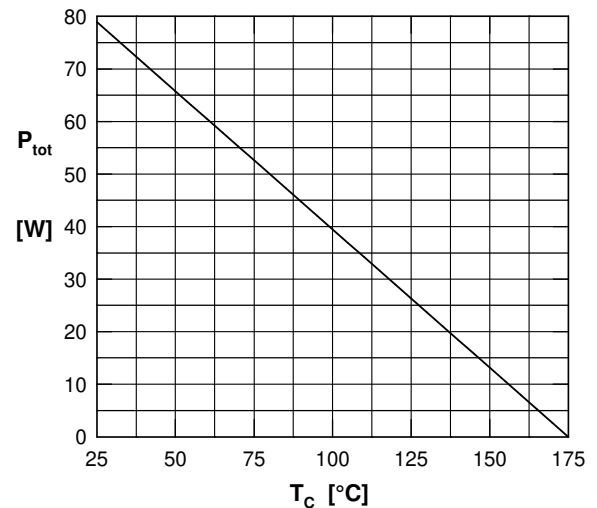

Fig. 4 Power derating

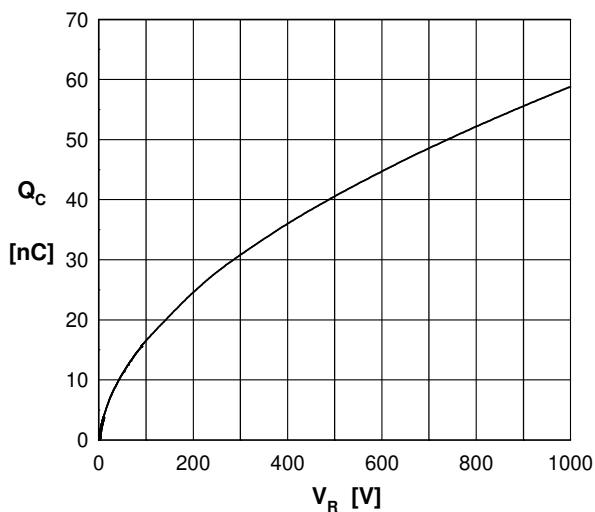

Fig. 5 Typ. recovery charge vs. reverse voltage

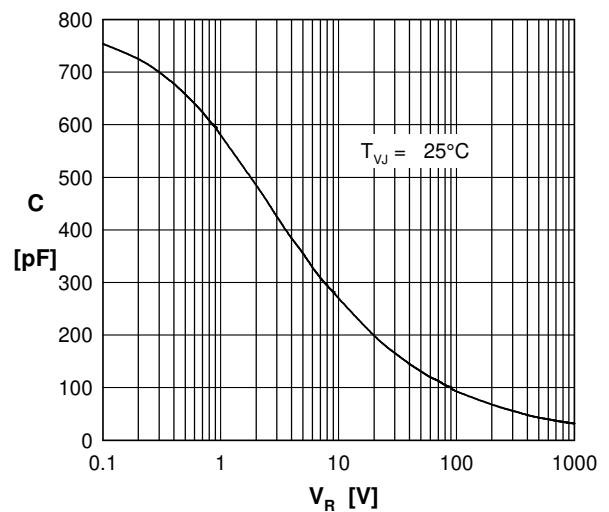

Fig. 6 Typ. junction capacitance vs. reverse Voltage

SiC Diode (per leg)

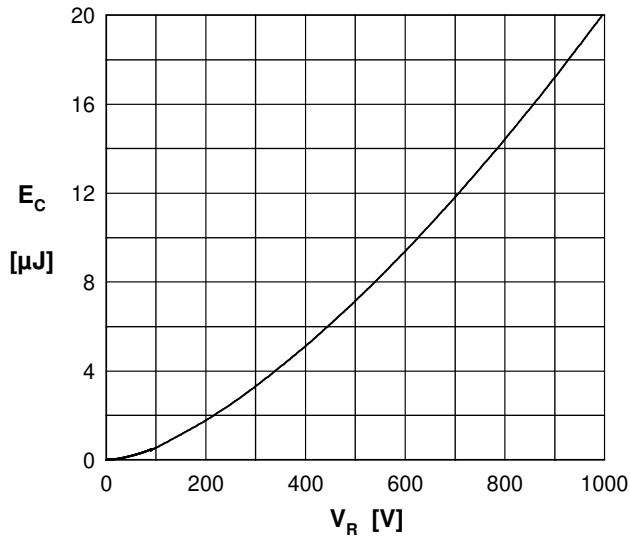

Fig. 7 Typical capacitance stored energy

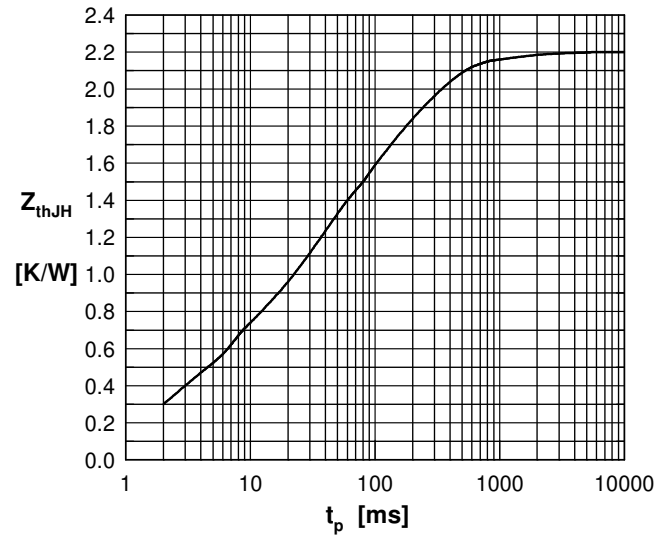

Fig. 8 Typ. transient thermal impedance