

Type 2 surge protection plug - VAL-US 480 ST - 2800743

Please be informed that the data shown in this PDF Document is generated from our Online Catalog. Please find the complete data in the user's documentation. Our General Terms of Use for Downloads are valid (<http://phoenixcontact.com/download>)



Surge protection connector type 2 with high-capacity varistor for VAL-MS base element, thermal monitoring, visual fault warning. Design: 480 V AC

The figure shows the VAL-US 347 ST version



Key commercial data

Packing unit	1 pc
Weight per Piece (excluding packing)	60.0 GRM
Custom tariff number	85363090
Country of origin	Germany

Technical data

Dimensions

Height	52.4 mm
Width	17.5 mm
Depth	55.3 mm

Ambient conditions

Degree of protection	IP20
Ambient temperature (operation)	-40 °C ... 80 °C
Ambient temperature (storage/transport)	-40 °C ... 80 °C
Altitude	≤ 2000 m (amsl (above mean sea level))
Permissible humidity (operation)	5 % ... 95 %
Shock (operation)	25g
Vibration (operation)	5g

General

Standards/specifications	IEC 61643-11 2011
	EN 61643-11 2012

Type 2 surge protection plug - VAL-US 480 ST - 2800743

Technical data

General

IEC test classification	II
	T2
EN type	T2
SPD design	Voltage-limiting type
Mode of protection	L-PEN
	L-PE
Mounting type	On base element
Color	black
Housing material	PA 6.6
Pollution degree	2
Distance between live and grounded parts	5 mm
Inflammability class according to UL 94	V-0
Type	Male
Number of positions	1
Surge protection fault message	Optical

Additional descriptions

Note	Usable in all low-voltage systems between L-N or L-PEN. Only usable in IT Systems between L-PE, if the exposed-conductive-parts (bodies) of the equipment of the low-voltage installation is connected to the earthing arrangement of the transformer substation. (interconnected earthing arrangement of the HV-transformer substation with the bodies of the LV-installation. $R_E = R_A$ accordance to IEC 60364-4-442 / VDE 0100-442 Fig. 44D / Example a)
------	---

Protective circuit

Nominal voltage U_N	400/690 V AC (TN)
	500 V AC (IT)
Nominal frequency f_N	60 Hz (50 Hz)
Maximum continuous operating voltage U_C	580 V AC
Residual current I_{PE}	≤ 0.25 mA
Standby power consumption P_C	≤ 150 mVA
Nominal discharge current I_n (8/20) μ s	15 kA
Maximum discharge current I_{max} (8/20) μ s	30 kA
Short-circuit current rating I_{SCCR}	25 kA
Voltage protection level U_p	≤ 2.5 kV
Residual voltage U_{res}	≤ 2.5 kV (at I_n)
	≤ 2.3 kV (at 10 kA)
	≤ 2.1 kV (at 5 kA)
	≤ 1.9 kV (at 3 kA)

Type 2 surge protection plug - VAL-US 480 ST - 2800743

Technical data

Protective circuit

TOV behavior at U_T	690 V AC (5 s / withstand mode)
Response time t_A	≤ 25 ns
Max. backup fuse with branch wiring	125 A AC (gG)

Connection data

Connection method	VALVETRAB plug-in system
-------------------	--------------------------

NEMA/UL protective circuit

UL class	Type 4 SPD for Type 2 applications
Maximum continuous operating voltage MCOV (L-N)	580 V AC
Nominal voltage U_N	480 V AC
Mode of protection	L-N
Power distribution system	1
Nominal frequency	50/60 Hz
Voltage protection rating VPR (L-N)	1.8 kV
Nominal discharge current I_n (L-N)	10 kA

Classifications

eCl@ss

eCl@ss 4.0	27140201
eCl@ss 4.1	27130801
eCl@ss 5.0	27130801
eCl@ss 5.1	27130801
eCl@ss 6.0	27130803
eCl@ss 7.0	27130803
eCl@ss 8.0	27130803

ETIM

ETIM 3.0	EC000472
ETIM 4.0	EC000472
ETIM 5.0	EC000472

UNSPSC

UNSPSC 6.01	30212010
UNSPSC 7.0901	39121610
UNSPSC 11	39121610
UNSPSC 12.01	39121610
UNSPSC 13.2	39121620

Type 2 surge protection plug - VAL-US 480 ST - 2800743

Approvals

Approvals

Approvals

UL Recognized / cUL Recognized / cULus Recognized

Ex Approvals

Approvals submitted

Approval details

UL Recognized

cUL Recognized

cULus Recognized

Drawings

Dimensioned drawing

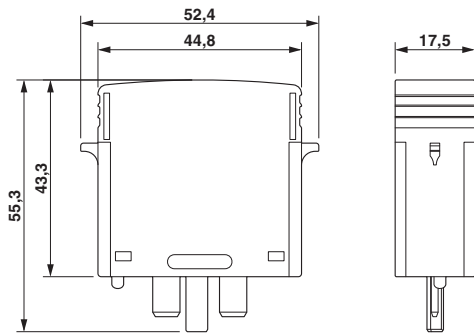

Circuit diagram



