

**General Description**

The MAX12005 evaluation kit (EV kit) provides a proven PCB layout that facilitates evaluation of the MAX12005 satellite switch RFIC. The EV kit is fully assembled and tested. A software control program with a graphical user interface (GUI) is available from [www.maximintegrated.com/evkitsoftware](http://www.maximintegrated.com/evkitsoftware), allowing full user control of the IC functions and settings.

The EV Kit has 75Ω RF lines. However, to make evaluation easy with standard 50Ω test equipment, there are 75Ω to 50Ω impedance transformation networks on-board at all input and output ports.

**Features**

- USB Interface to Host PC
- Easy-to-Use GUI Software
- 75Ω to 50Ω On-Board Impedance Transformation Network at All Ports
- Fully Assembled and Tested

***Ordering Information** appears at end of data sheet.*

**EV Kit Contents List**

QTY	DESCRIPTION
1	Circuit board assembly: MAX12005 EV kit
1	USB high-speed A-to-mini B cable, 5ft (1.5m)

**Quick Start**

The EV kit is fully assembled and factory tested. Follow the instructions in the [Connections and Setup](#) section to test the device. The EV kit features two methods to control the IC: either through a standard SPI interface or by using Tone/Voltage, Tone Burst, using DiSEqC 1.x/2.x. This procedure describes operation with standard SPI interface.

**Test Equipment Required**

This section lists the recommended test equipment to verify the operation of the MAX12005. It is intended as a guide only and substitutions may be possible:

- MAX12005 EV kit
- DC supply capable of delivering +3V and 300mA of continuous current
- One HP8648D or equivalent signal source capable of generating up to 2.2GHz
- HP8561E or equivalent RF spectrum analyzer with a minimum 100kHz to 3GHz frequency range
- PC, laptop or tablet with Microsoft Windows XP®, Windows® 7, 8 OS and a USB port
- USB-A male to mini-USB cable

**Connections and Setup**

This section provides step-by-step instructions for getting the EV kit up and running with SPI.

**Software Setup**

- 1) Download the MAX12005 control software zip folder from <https://www.maximintegrated.com>. Unzip the folder before installing the software.
- 2) Install the CDM20814\_Setup.exe file from the Interface\_Driver folder by double-clicking on the file icon.
- 3) Restart your computer.
- 4) Install the software by double-clicking on the Setup.exe file from the MAX12005\_GUI folder. Follow the instructions in the installation Wizard.
- 5) Now select [Control Panel](#) from the Windows [Start](#) menu, and double-click on System/Device Manager, expand the Universal Serial Bus controllers icon, and there should be a new USB device, USB Serial Converter. This is highlighted in [Figure 2](#).
- 6) Go to the installation directory and start the Satellite Reception Switch Control v2.1.2.exe GUI software by double-clicking on the icon shown in [Figure 3](#).



**Software Description**

The GUI has several control fields (**Receiver 1– Receiver 4, Configuration, Cascade, Mode, and Gain**) and control buttons (**Default Settings** (brings the GUI back to default settings), **Send** (sends the current settings to the EV Kit), and a **Quit**).

The **Receiver** group boxes are used to set the RF output states. The **Receiver 1–Receiver 4** group boxes correspond to RF Out 1–RF Out 4. Within each Receiver group box there are seven parameters that define the source of the RF signal, the gain setting, and the type of tone envelope.

If the **Cascade** drop-down list in the **Configuration** group box is set to **Single**, each RF output has eight inputs to select from, such as satellite A or B, low band or high band, horizontal or vertical polarization. These labels do not necessarily refer to the actual sources, but are labeled for user convenience. All input configurations are identical.

Register 01 has the bits to control the mode and switching action of the IC. The three bits; satellite, polarization and band, make eight possible combinations to select which of the eight RFIN1-8 will be seen on a particular output. [Table 1](#) shows what the GUI labels are equivalent to and [Table 2](#) shows the possible combinations on each output RFOUT1-4.

In **Cascade** mode, two EV kits are required. See the MAX12005 IC data sheet for a typical configuration. In this mode, the **Option** switch is enabled, allowing selection of up to four satellite inputs.

**Hardware Setup**

- 1) With the output disabled, connect the +3V supply to the VCC terminal on the MAX12005EV Kit.
- 2) Connect the supply ground to the GND terminal on the MAX12005 EV Kit.
- 3) Connect a USB cable between the MAX12005 EV Kit and the PC with MAX12005 control software.
- 4) Set the S202 switch on the EV Kit board to the SPI ON position (right-hand position or towards the USB connector). [Figure 1](#) shows the location of the S202 switch.
- 5) Set the signal generator to accurately deliver -37dBm (equivalent to 70dBµV) CW tone at 950MHz.
- 6) Connect it to one of the eight RFIN1-8 inputs ports.
- 7) Connect one of the four RFOUT1-4 ports to the spectrum analyzer.
- 8) Set the center frequency on the spectrum analyzer to 950MHz and span to 1MHz.
- 9) Turn on the +3V power supply and note the current. It should be approximately 135mA.
- 10) Use the software control GUI to select the input to show up on the output port connected to the spectrum analyzer. Refer to MAX12005 SPI Registers, [Table 1](#) and [Table 2](#) to understand the switching options.
- 11) On the spectrum analyzer, the output RF signal should be approximately -44dBm at 950MHz with Output Gain set to default +6dB.

**Note:** Always hit **Send** after making any changes in the GUI.

**Note:** All RF lines are 75Ω. However, to make testing easy with standard 50Ω test equipment, there are 75Ωto 50Ω impedance transformation networks on-board at all input and output ports. These resistive impedance transformation networks have a loss of 6dB across them. During testing, unused RF connectors, either inputs or outputs, must be terminated in 50Ω loads.

**Table 1. Software GUI Labels and Functions**

BIT NAME	FUNCTION
Option	0 = Master/Single IC 1 = Slave IC
Satellite	0 = Sat A 1 = Sat B
Polarization	0 = Vertical 1 = Horizontal
Band	0 = low 1 = high

Table 2: Switching Options

SATELLITE BIT	POLARIZATION BIT	BAND BIT	GUI LABEL	INPUT SELECTED
0	0	0	Sat A, vertical, low	RFIN1
0	0	1	Sat A, vertical, high	RFIN3
0	1	0	Sat A, horizontal, low	RFIN2
0	1	1	Sat A, horizontal, high	RFIN4
1	0	0	0 Sat B, vertical, low	RFIN5
1	0	1	Sat B, vertical, high 0	RFIN7
1	1	0	Sat B, horizontal, low	RFIN6
1	1	1	Sat B, horizontal, high	RFIN8

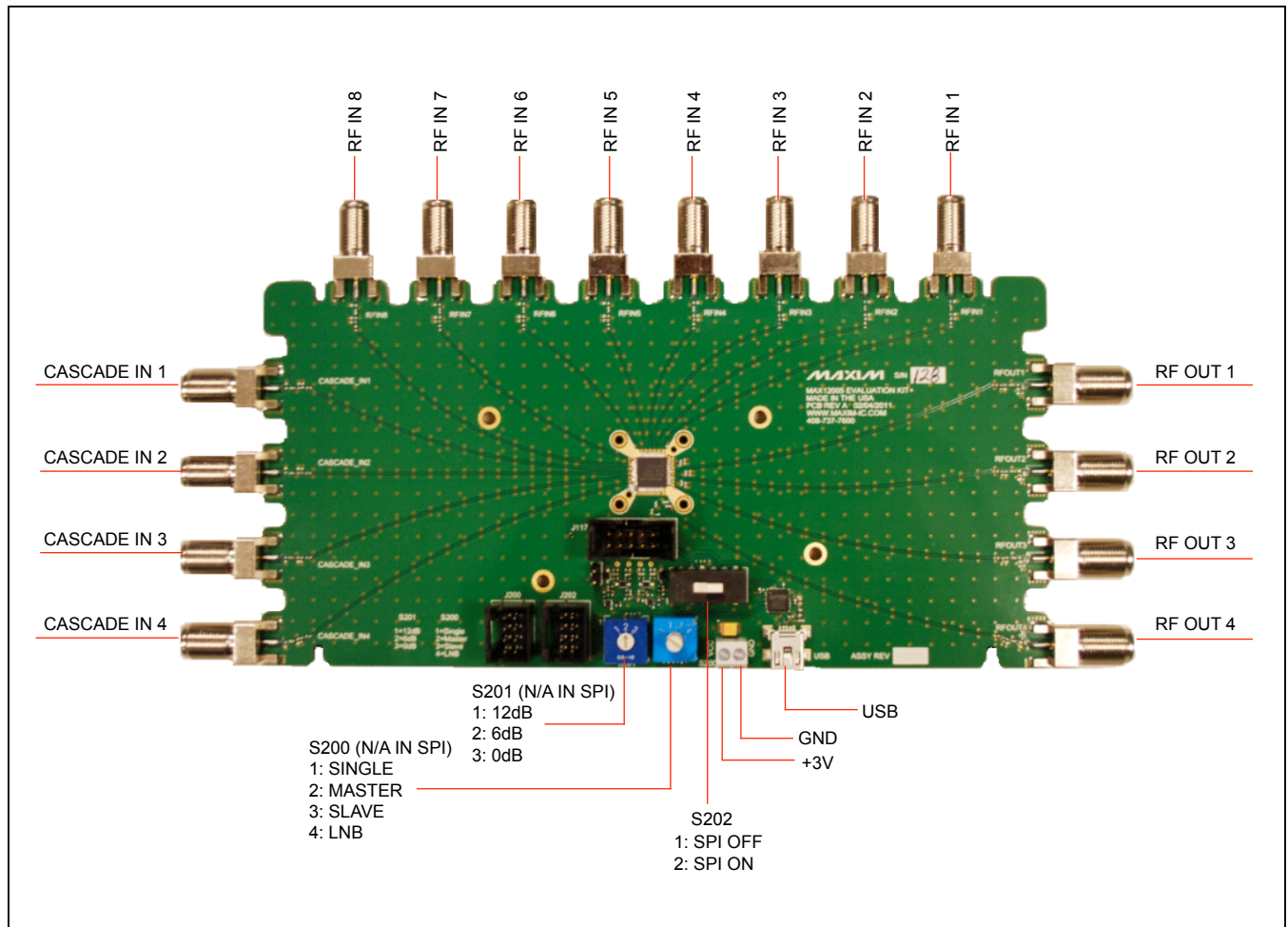

Figure 1. MAX12005 EV KIT.

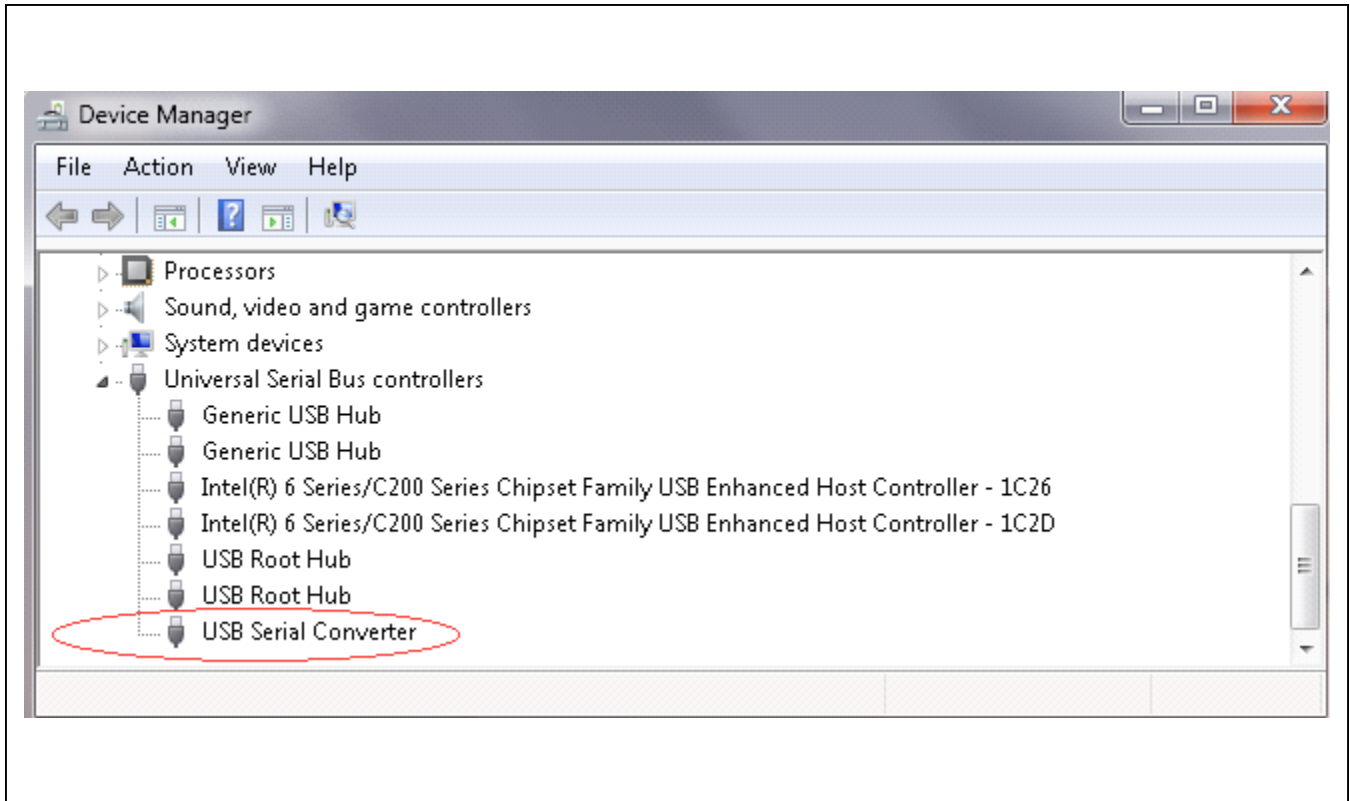

Figure 2. Showing installation of the USB Serial Converter Device



Figure 3. Software GUI Icon

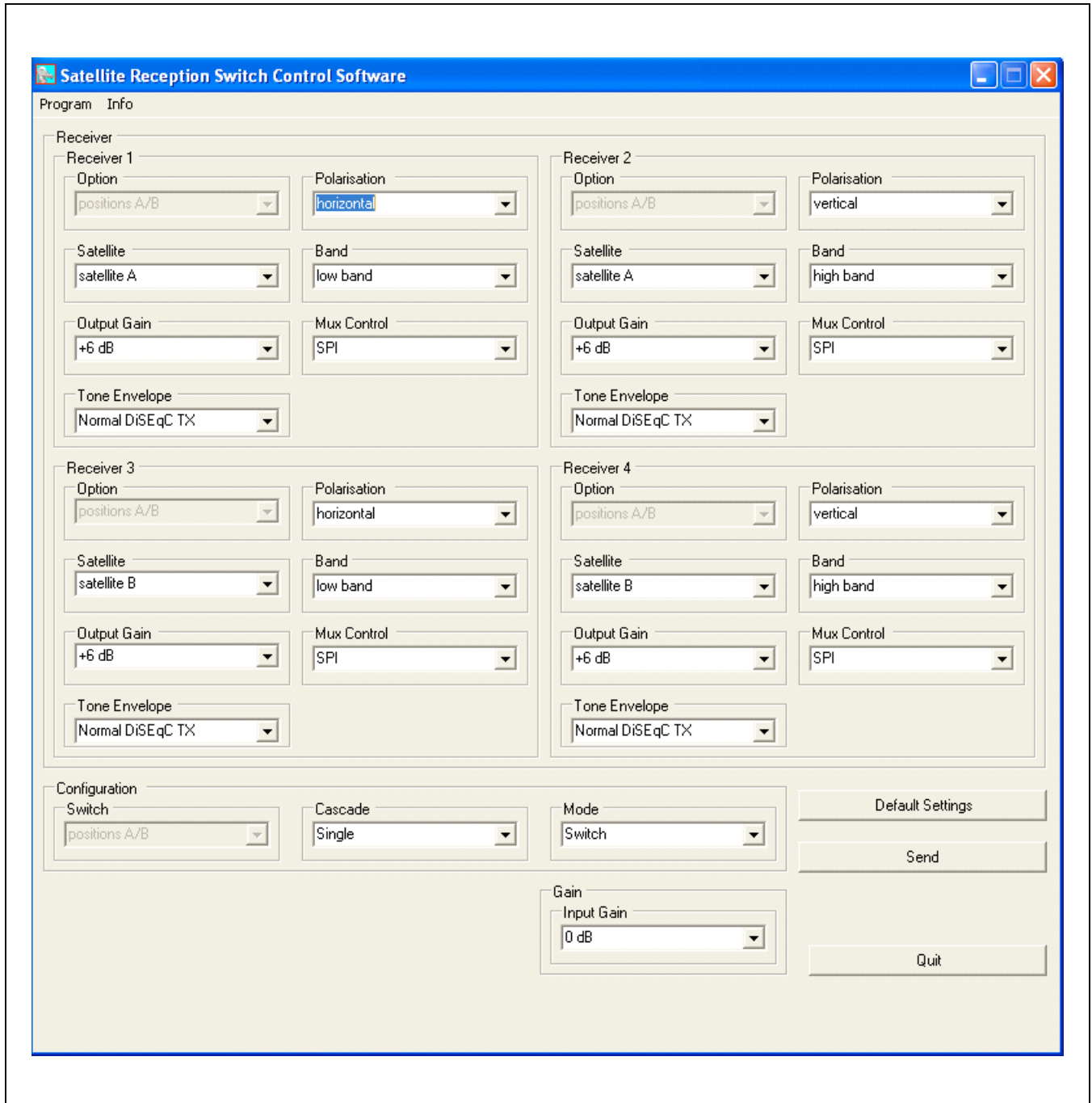

Figure 4. Screenshot of the MAX12005 EV Kit GUI

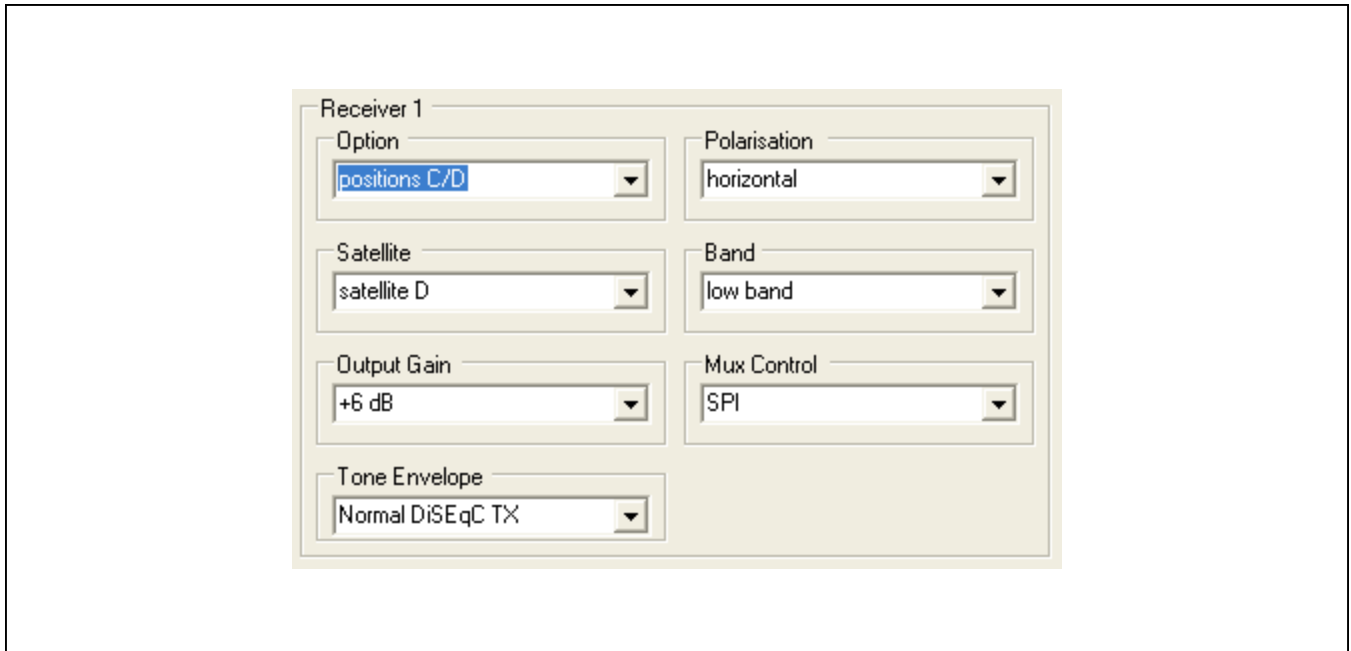

Figure 5. Cascade Mode Allows for Up to Four Satellite Inputs (Labeled A–D).

**MAX12005 SPI Registers**

Address range 00 to 11 registers are write only.

ADDRESS	BIT	NAME	FUNCTION	DEFAULT
00 (Configuration_reg)	15:11	Unused	—	—
	10	tone_env_en4	0 = Normal DiSEqC_TX4 output. 1 = DiSEqC_TX1 outputs 22kHz envelope as received by DiSEqC_RX4.	0
	9	tone_env_en3	0 = Normal DiSEqC_TX4 output. 1 = DiSEqC_TX1 outputs 22kHz envelope as received by DiSEqC_RX3.	0
	8	tone_env_en2	0 = Normal DiSEqC_TX4 output. 1 = DiSEqC_TX1 outputs 22kHz envelope as received by DiSEqC_R2.	0
	7	tone_env_en1	0 = Normal DiSEqC_TX4 output. 1 = DiSEqC_TX1 outputs 22kHz envelope as received by DiSEqC_RX1.	0
	6	option	0 = Master/single IC, 1 = Slave IC	0
	5	cascade	0 = Single, 1 = Cascaded	0
	4	mode	0 = Switch, 1 = LNB	0
	3:0	mux_ctrl	Switch matrix controlled by: 0 = DiSEqC 1 = SPI Separately for each receiver: Bit 0 = RFOUT1, Bit 1 = RFOUT2 Bit 2 = RFOUT3, Bit 3 = RFOUT4	0000
01 (Mode & Switch_reg)	15	option 3 (RFOUT4)	0 = Master/single IC, 1 = Slave IC	0
	14	satellite 3 (RFOUT4)	0 = RFIN1–RFIN4 (Satellite A) 1 = RFIN5–RFIN8 (Satellite B)	0
	13	polarization 3 (RFOUT4)	0 = RFIN1, RFIN3, RFIN5, RFIN7 1 = RFIN2, RFIN4, RFIN6, RFIN8	0
	12	band 3 (RFOUT4)	0 = RFIN1, RFIN2, RFIN5, RFIN6 1 = RFIN3, RFIN4, RFIN7, RFIN8	0
	11	option 2 (RFOUT3)	0 = Master/single IC, 1 = Slave IC	0
	10	satellite 2 (RFOUT3)	0 = RFIN1–RFIN4, 1 = RFIN5–RFIN8	0
	9	polarization 2 (RFOUT3)	0 = RFIN1, RFIN3, RFIN5, RFIN7 1 = RFIN2, RFIN4, RFIN6, RFIN8	0
	8	band 2 (RFOUT3)	0 = RFIN1, RFIN2, RFIN5, RFIN6 1 = RFIN3, RFIN4, RFIN7, RFIN8	0
	7	option 1 (RFOUT2)	0 = Master/single IC, 1 = Slave IC	0
	6	satellite 1 (RFOUT2)	0 = RFIN1–RFIN4, 1 = RFIN5–RFIN8	0
5	polarization 1 (RFOUT2)	0 = RFIN1, RFIN3, RFIN5, RFIN7 1 = RFIN2, RFIN4, RFIN6, RFIN8	0	

## MAX12005 SPI Registers (continued)

Address range 00 to 11 registers are write only.

ADDRESS	BIT	NAME	FUNCTION	DEFAULT
01 (Mode & Switch_reg)	4	band 1 (RFOUT2)	0 = RFIN1, RFIN2, RFIN5, RFIN6 1 = RFIN3, RFIN4, RFIN7, RFIN8	0
	3	option 0 (RFOUT1)	0 = Master/single IC, 1 = Slave IC	0
	2	satellite 0 (RFOUT1)	0 = RFIN1–RFIN4, 1 = RFIN5–RFIN8	0
	1	polarization 0 (RFOUT1)	0 = RFIN1, RFIN3, RFIN5, RFIN7 1 = RFIN2, RFIN4, RFIN6, RFIN8	0
	0	band 0 (RFOUT1)	0 = RFIN1, RFIN2, RFIN5, RFIN6 1 = RFIN3, RFIN4, RFIN7, RFIN8	0
10 (Gain_reg)	15:10	unused	—	0
	9:8	in_gain	Common input gain RFIN1 through RFIN8: Bit 8 = 0, Bit 9 = 0: 0dB Bit 8 = 1, Bit 9 = 0: 6dB Bit 8 = 0, Bit 9 = 1: 12dB	00
	7:6	out_gain3	Output gain RFOUT4 (see address 11, bits 15:10) Bit 6 = 0, Bit 7 = 0: 0dB Bit 6 = 1, Bit 7 = 0: -6dB Bit 6 = 0, Bit 7 = 1: +6dB	00
	5:4	out_gain2	Output gain RFOUT3 (see address 11, bits 15:10) Bit 4 = 0, Bit 5 = 0: 0dB Bit 4 = 1, Bit 5 = 0: -6dB Bit 4 = 0, Bit 5 = 1: +6dB	00
	3:2	out_gain1	Output gain RFOUT2 (see address 11, bits 15:10) Bit 2 = 0, Bit 3 = 0: 0dB Bit 2 = 1, Bit 3 = 0: -6dB Bit 2 = 0, Bit 3 = 1: +6dB	00
	1:0	out_gain0	Output gain RFOUT1 (see address 11, bits 15:10) Bit 0 = 0, Bit 1 = 0: 0dB Bit 0 = 1, Bit 1 = 0: -6dB Bit 0 = 0, Bit 1 = 1: +6dB	00
11 (Output Gain Select Mode & Calibrate_reg)	15:10	unused	—	000000
	9	External test clock	0 = Pin 16 inactive 1 = Pin 16 is clock input for DiSEqC interface.	0
	8	fuse output impedance	0 = 10kΩ (no need to use or test) 1 = 100kΩ	0
	7	output cut_off	Cut-off oscillator calibration output (burn = 1)	0
	6	burn_gasket	Burn gasket (burn = 1)	0
	5	burn_in	Burn_in calibration value (burn = 1)	0
	4:0	calibrate	DiSEqC clock frequency calibration value	01100



### Component Information, PCB Layout, and Schematic

See the following links for component information, PCB layout diagrams, and schematic.

- [MAX12005 EV BOM](#)
- [MAX12005 EV PCB Layout](#)
- [MAX12005 EV Schematic](#)

### Ordering Information

PART	TYPE
MAX12005EVKIT#	EV Kit

*#Denotes RoHS compliant.*

## Revision History

REVISION NUMBER	REVISION DATE	DESCRIPTION	PAGES CHANGED
0	5/12	Initial release	—
1	5/16	Updated Quick Start section	1–10
2	5/16	Updated part number in <i>Ordering Information</i> table	9

For pricing, delivery, and ordering information, please contact Maxim Direct at 1-888-629-4642, or visit Maxim Integrated's website at [www.maximintegrated.com](http://www.maximintegrated.com).

*Maxim Integrated cannot assume responsibility for use of any circuitry other than circuitry entirely embodied in a Maxim Integrated product. No circuit patent licenses are implied. Maxim Integrated reserves the right to change the circuitry and specifications without notice at any time.*

DESIGNATION	QTY	DESCRIPTION
+8V, 3V, ADDR, ARM_MONITOR, DSQOUT, EXTM, EXT_CLK, GROUND, START_MONITOR	9	Single gold pin Sullins PBC36SAAN
ARM, START	2	Normally off momentary SPST switches Tyco FSM2JSMA
C1, C71	2	30pF $\pm 5\%$ ceramic capacitors (0603) Murata GRM1885C1H300J
C1L, C3L, C5L, C9L	4	100 $\mu$ F electrolytic capacitors SANYO 35MV100AX
C2	1	0.1 $\mu$ F $\pm 10\%$ , ceramic capacitor (0603) Murata GRM188R71C104K
C2L, C7L	2	0.1 $\mu$ F $\pm 10\%$ , ceramic capacitors (0603) Murata GRM188R71E104K
C3, C21, C24, C12L, C12L1, C13L, C13L1, CD1– CD4	11	0.01 $\mu$ F $\pm 10\%$ , ceramic capacitors (0603) Murata GRM188R71E103K
C4L, C6L	2	0.47 $\mu$ F $\pm 10\%$ , ceramic capacitors (0603) Murata GRM188R71E474K
C8L, C10L, C11L	3	0.22 $\mu$ F $\pm 10\%$ , 0603 ceramic capacitors (0603) Murata GRM188R71E224K
C22	1	4.7 $\mu$ F $\pm 10\%$ , ceramic capacitor (0603) Murata GRM188R60J475K
COMP, RF_BOARD	2	20-pin (2 x 10) headers, 0.1in centers Sullins PEC36DAAN
D1	1	25V Schottky diode (SOD123) Nihon EP05Q03L
D2, D4	2	25V Schottky diodes (SOD123) General Semi BAT43W
D3	1	25V Schottky diode (Radial) Philips Semi 1N4001
DRXA–DRXD, DTXA–DTXD, JEN, JGAIN, JMODE, USB_J1–USB_J19	30	2-pin jumper blocks, 0.1in spacing Sullins PEC36SAAN
FBEAD	1	470 $\Omega$ $\pm 2\%$ , 10MHz ferrite bead (0603) Murata BLM18HG471SN1D
J1	1	USB type-B connector Assmann AU_Y1007
L1L	1	22 $\mu$ H $\pm 10\%$ inductor (1210) Murata LQH3C221K34
L2L	1	1k $\Omega$ , 100mA ferrite bead (0603) Murata BLM18BD102 SN1D
L3L	1	220 $\mu$ H $\pm 10\%$ inductor (1812) Murata LQH43CN221K03
R1	1	100 $\Omega$ $\pm 5\%$ resistor (1206)
R2	1	11k $\Omega$ $\pm 1\%$ resistor (1206)
R3	1	10k $\Omega$ $\pm 1\%$ resistor (1206)
R4	1	15 $\Omega$ $\pm 5\%$ resistor (1206)
R5	1	100 $\Omega$ $\pm 5\%$ resistor (2010)
R7, R45–R50	7	47k $\Omega$ , 5V SIP resistors Bourns 4310R-101-473
R33, R34	2	1k $\Omega$ $\pm 1\%$ resistors (0603)

R39, R40, R41	3	2k $\Omega$ $\pm$ 1% resistors (1206)
R42	1	47k $\Omega$ $\pm$ 1% resistor (1206)
R43	1	2.7k $\Omega$ $\pm$ 5% resistor (2010)
R44	1	1.02k $\Omega$ $\pm$ 5% resistor (2010)
R51, R59–R65	8	10k $\Omega$ $\pm$ 5% resistors (2010)
R54, R55	2	47k $\Omega$ $\pm$ 5% resistors (1206)
S1–S7	7	8-position DIP switches CTS Corp. 206-8
U1–U6	6	8-bit parallel-load shift registers TI 74HC165
U7–U12, U17–U20	10	Quad 2-input positive-nand gates TI 74HC00
U13, U14	2	Sync 4-bit up/down binary counters TI 74HC193
U15, U16	2	Dual D-type positive edge-triggered flip-flops TI 74HC74
U21	1	Decade counter Motorola MC74HC4017(J,N,D)
U22	1	LNB supply and control IC with step-up and I <sup>2</sup> C interface STMicro LNBH23
U23	1	FTDI USB-to-parallel RS-245 IC Saelig Co. FT245R

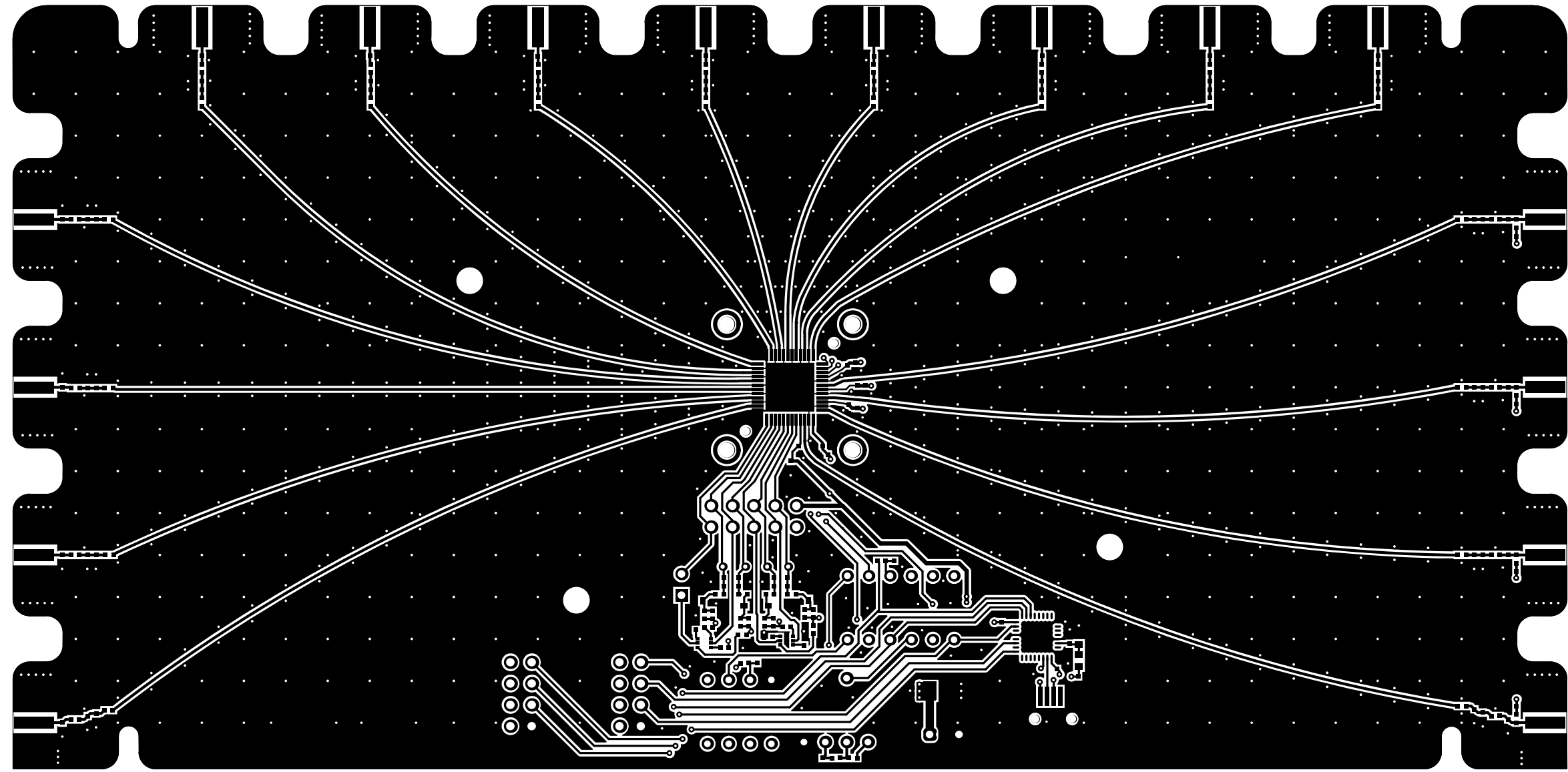

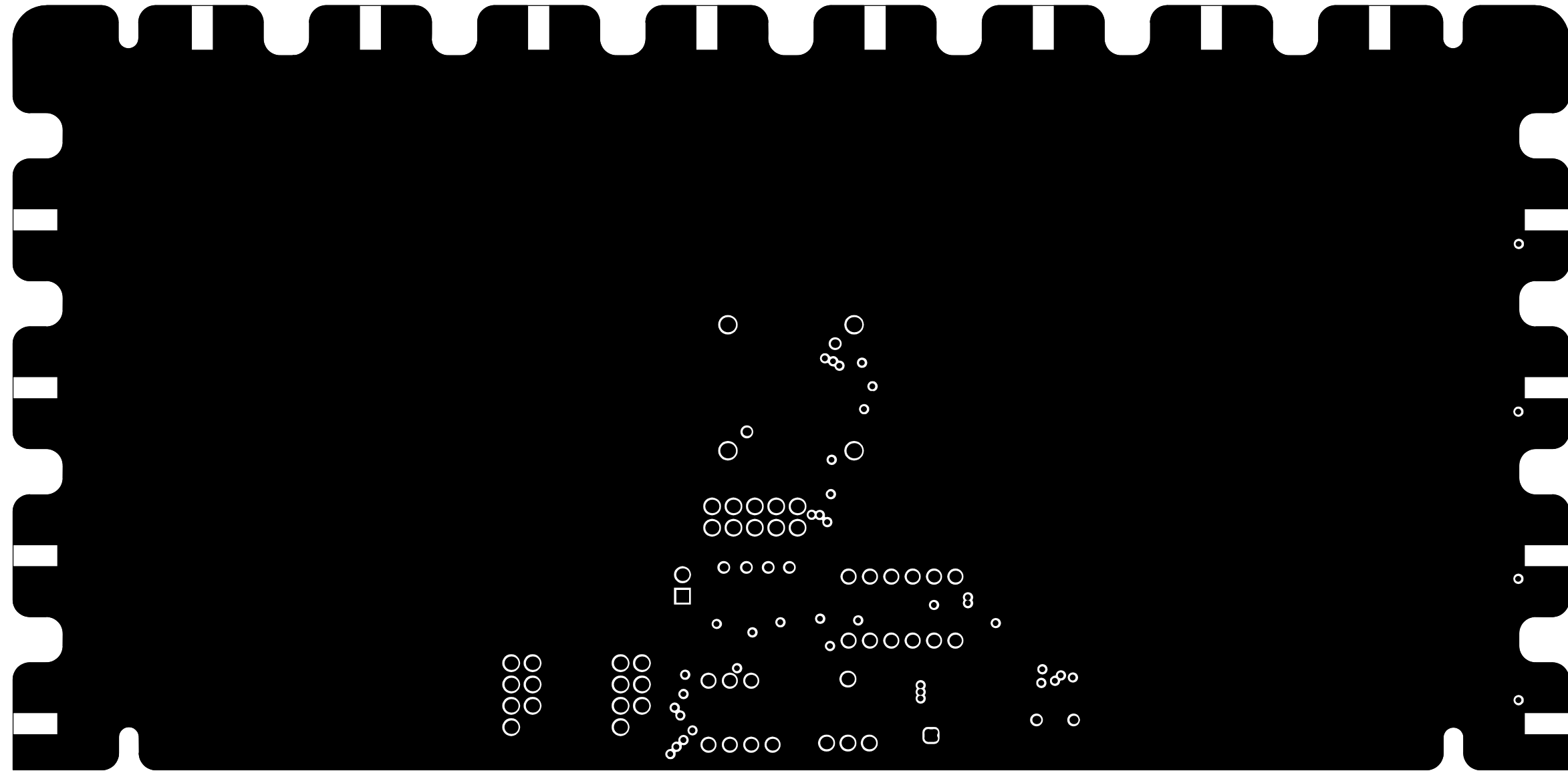

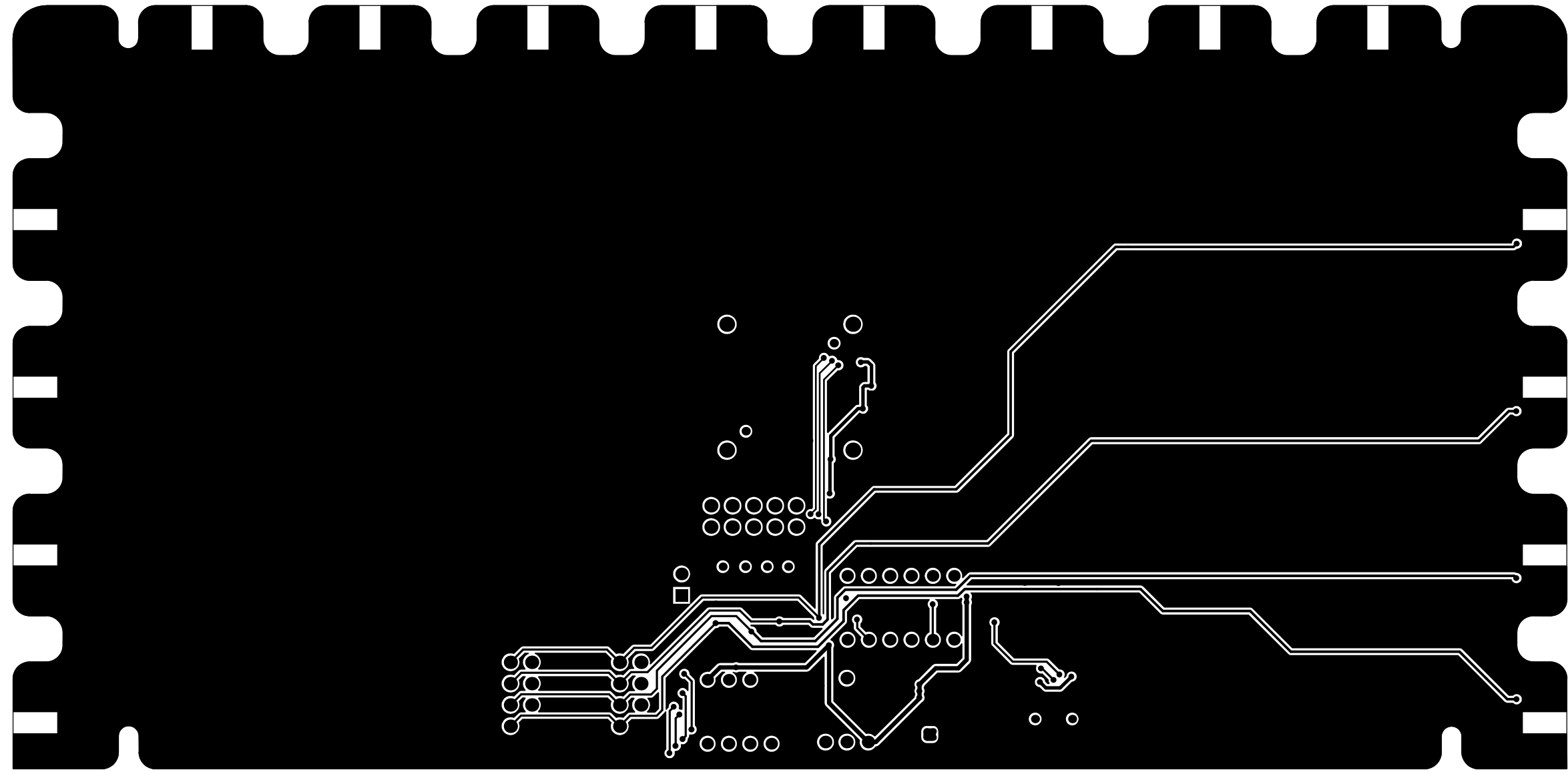

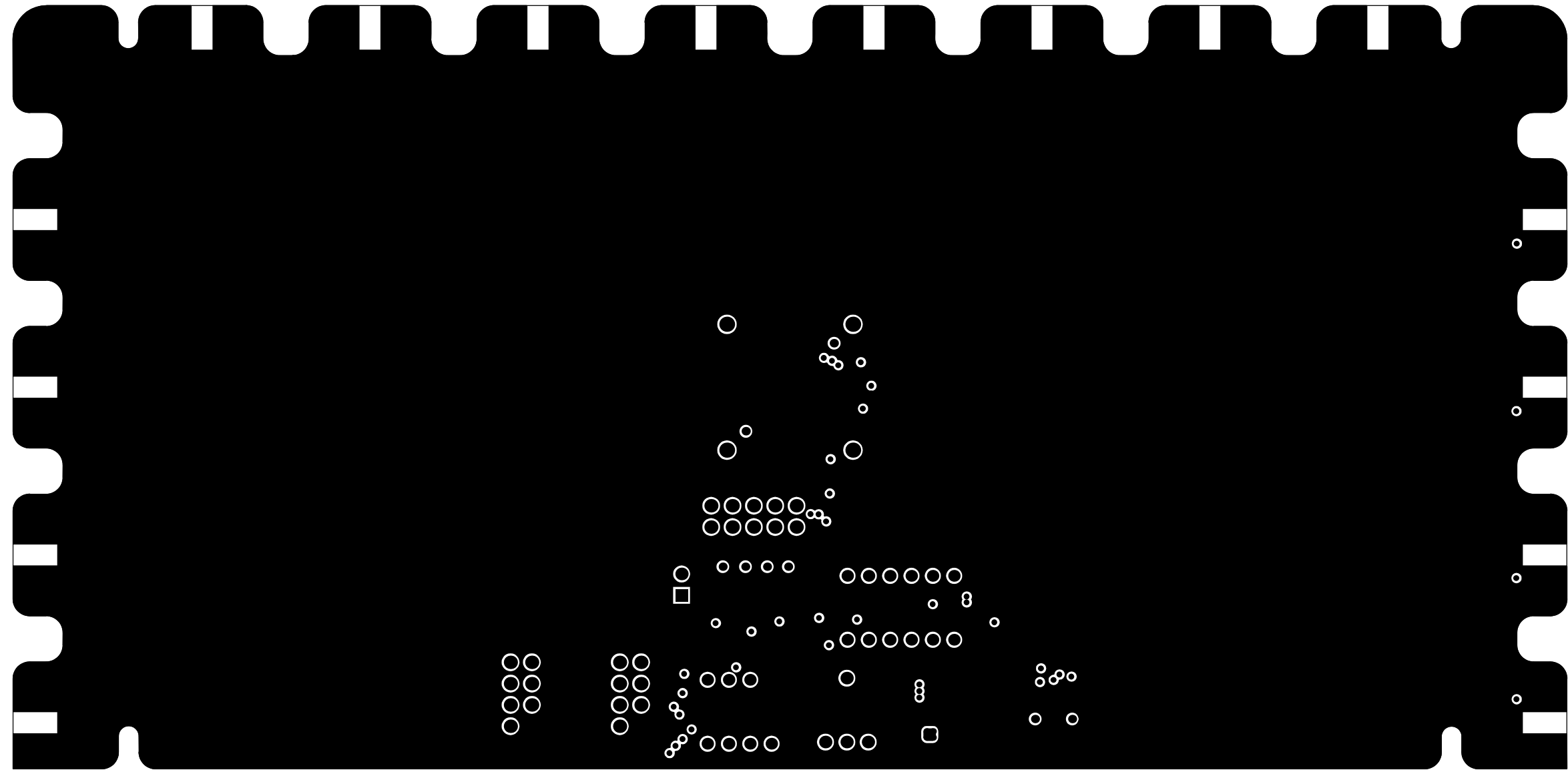





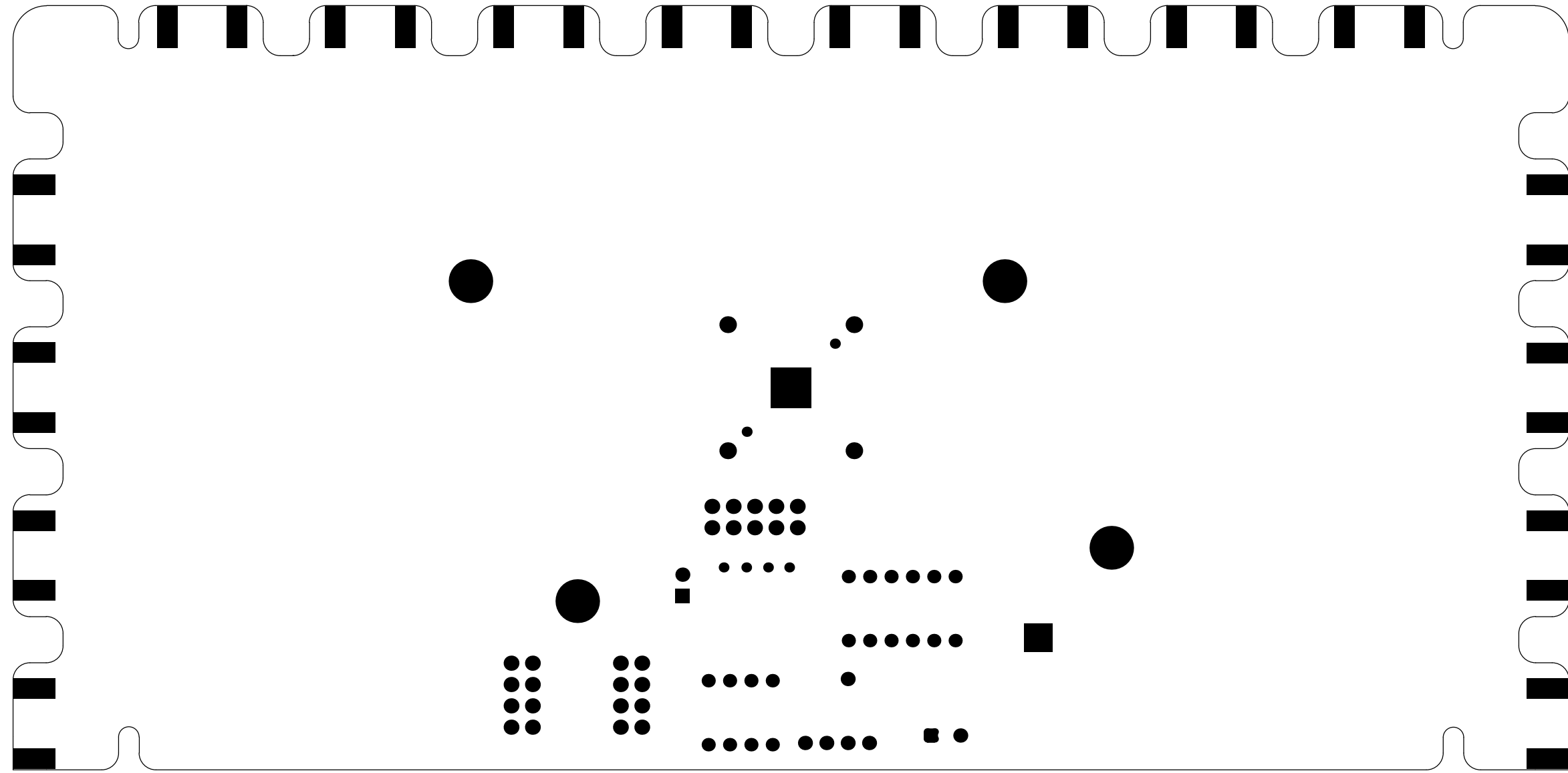

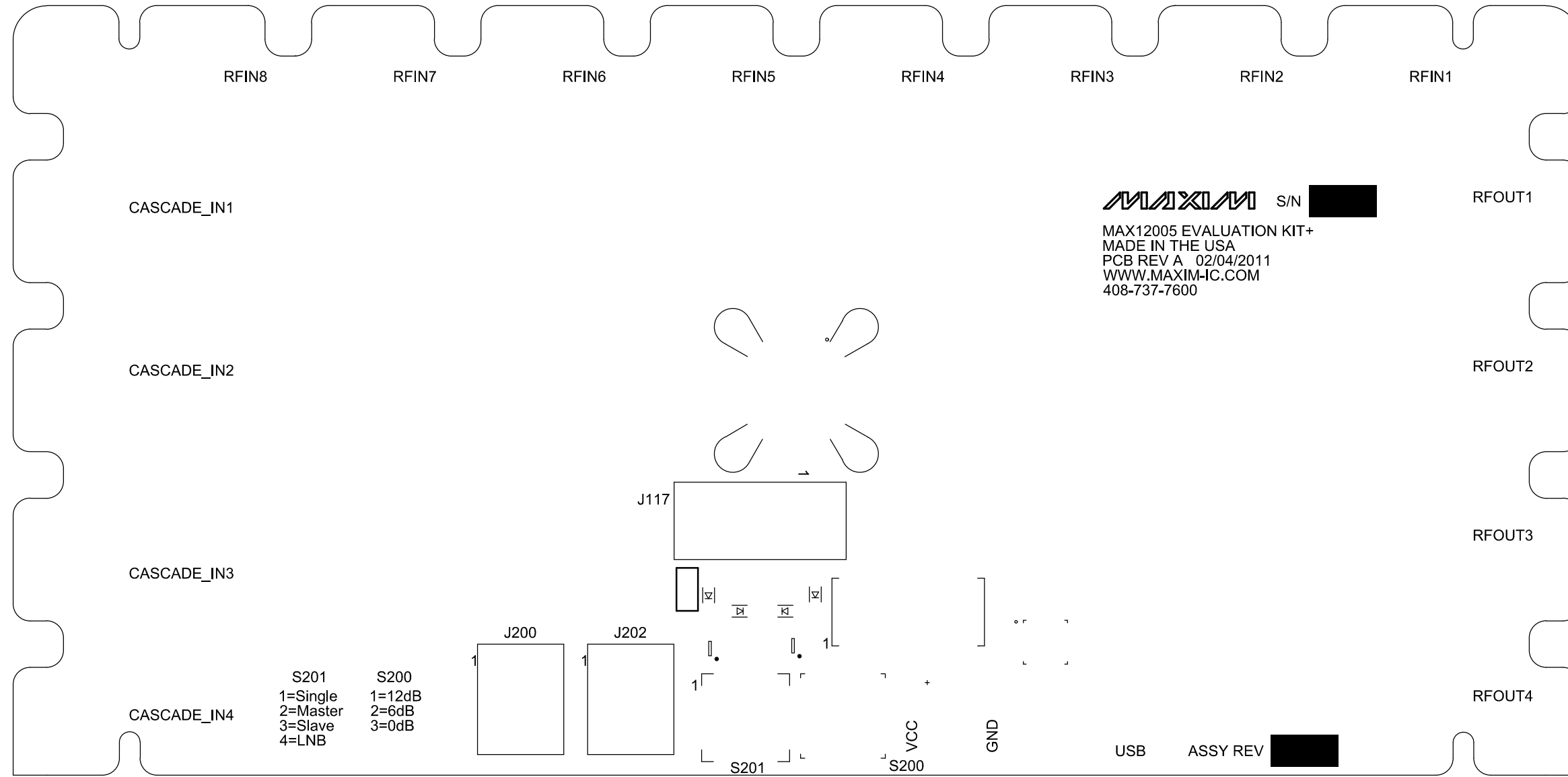

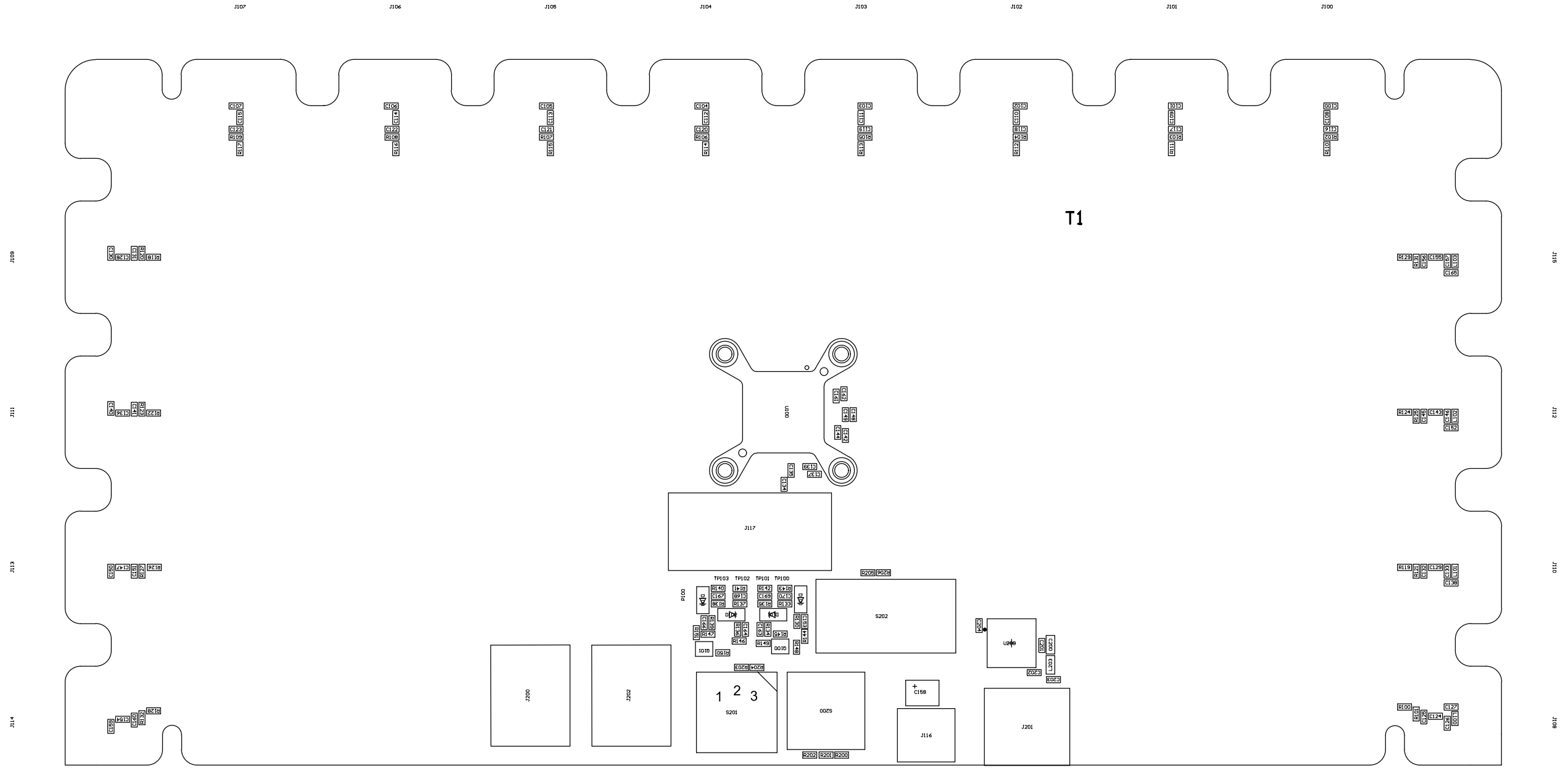

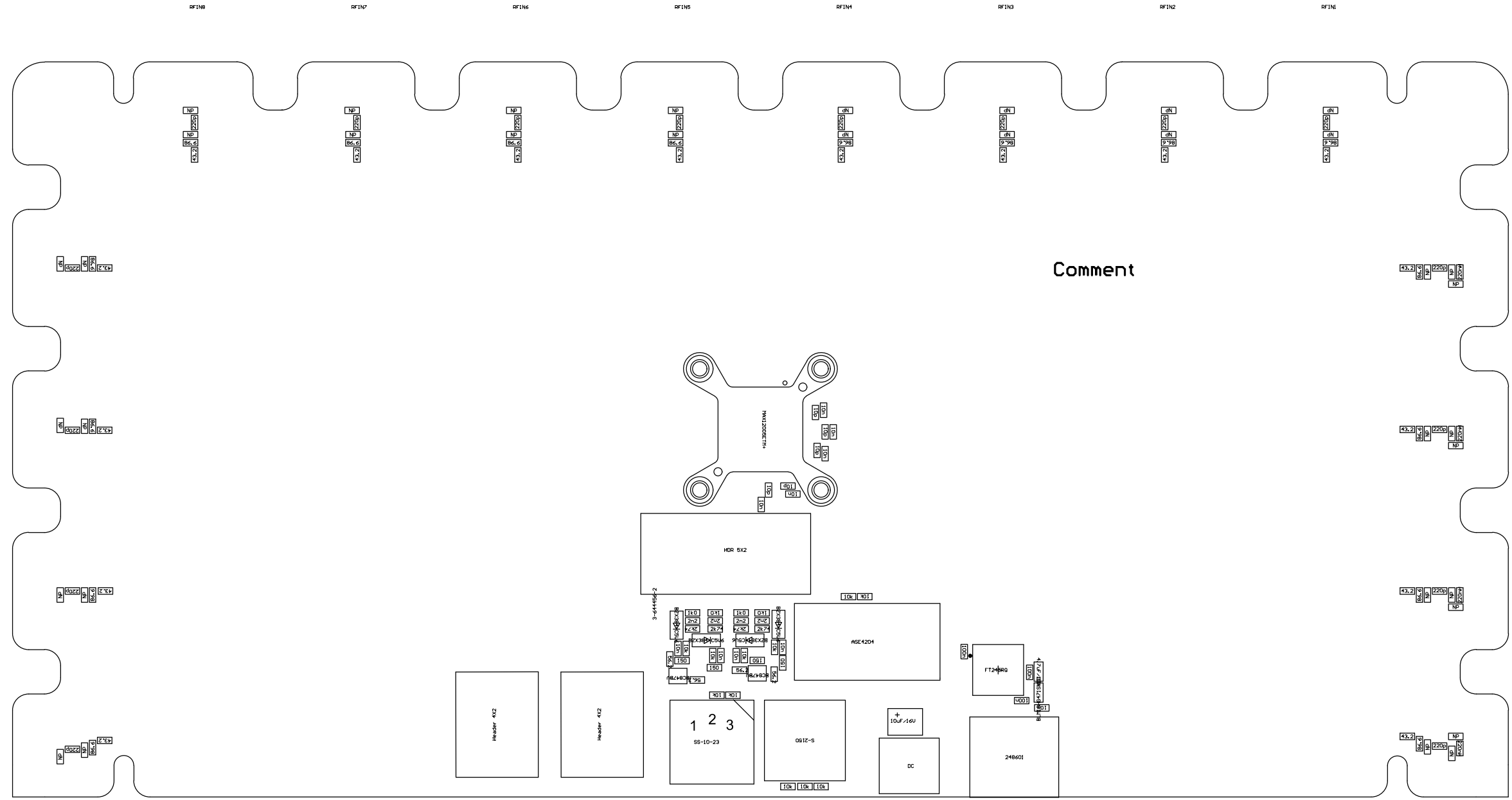

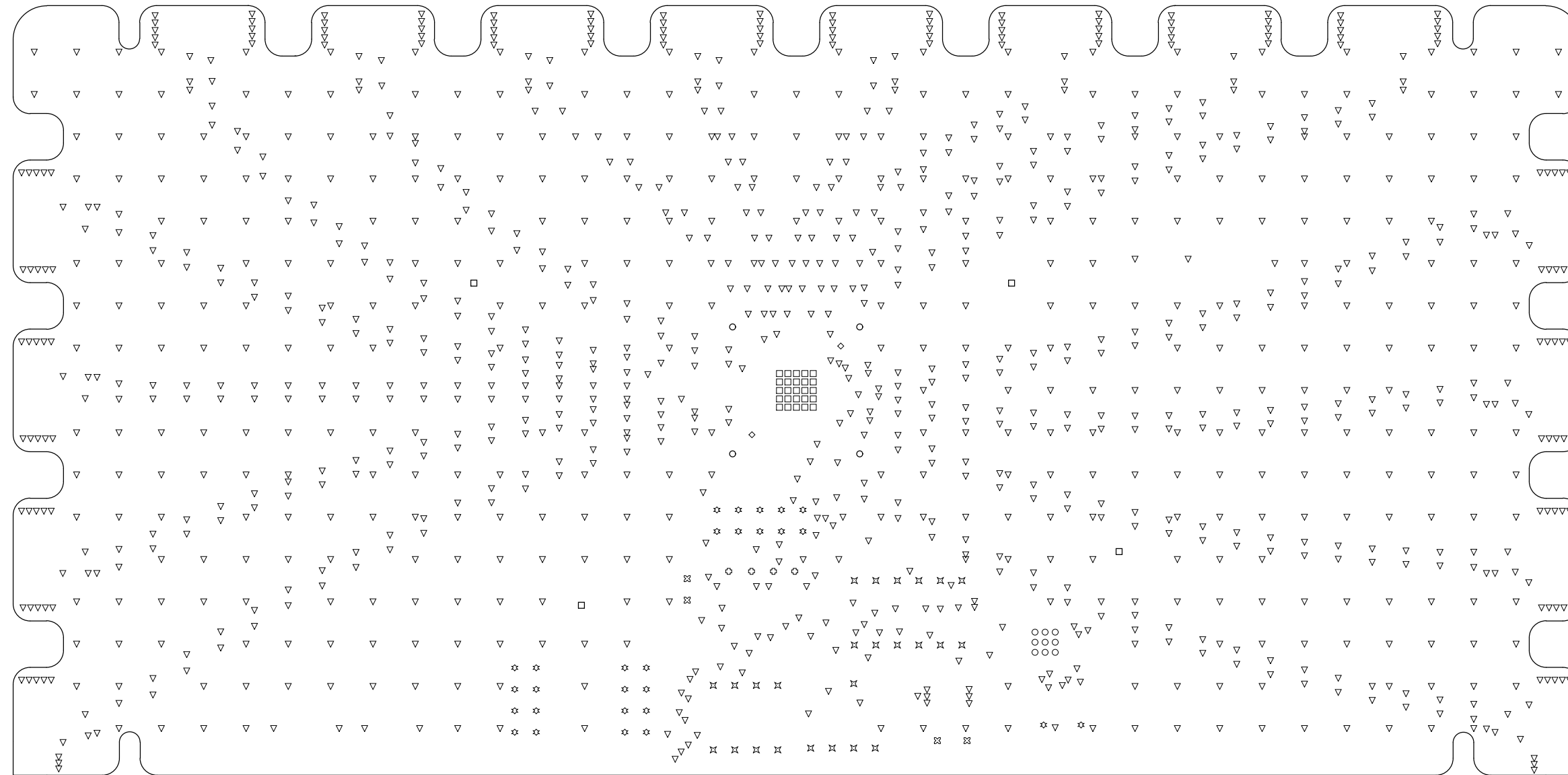

Symbol	Hit Count	Tool Size	Plated	Hole Type
□	25	0.254mm (10mil)	PTH	Round
▽	1229	0.3mm (11.811mil)	PTH	Round
○	9	0.4mm (15.748mil)	PTH	Round
⊙	4	0.5mm (19.685mil)	PTH	Round
⋈	25	0.8mm (31.496mil)	PTH	Round
⋈	4	0.9mm (35.433mil)	PTH	Round
*	28	1mm (39.37mil)	PTH	Round
◇	2	1.02mm (40.157mil)	PTH	Round
○	4	1.8mm (70.866mil)	PTH	Round
□	4	3.175mm (125mil)	PTH	Round
	1334 Total			

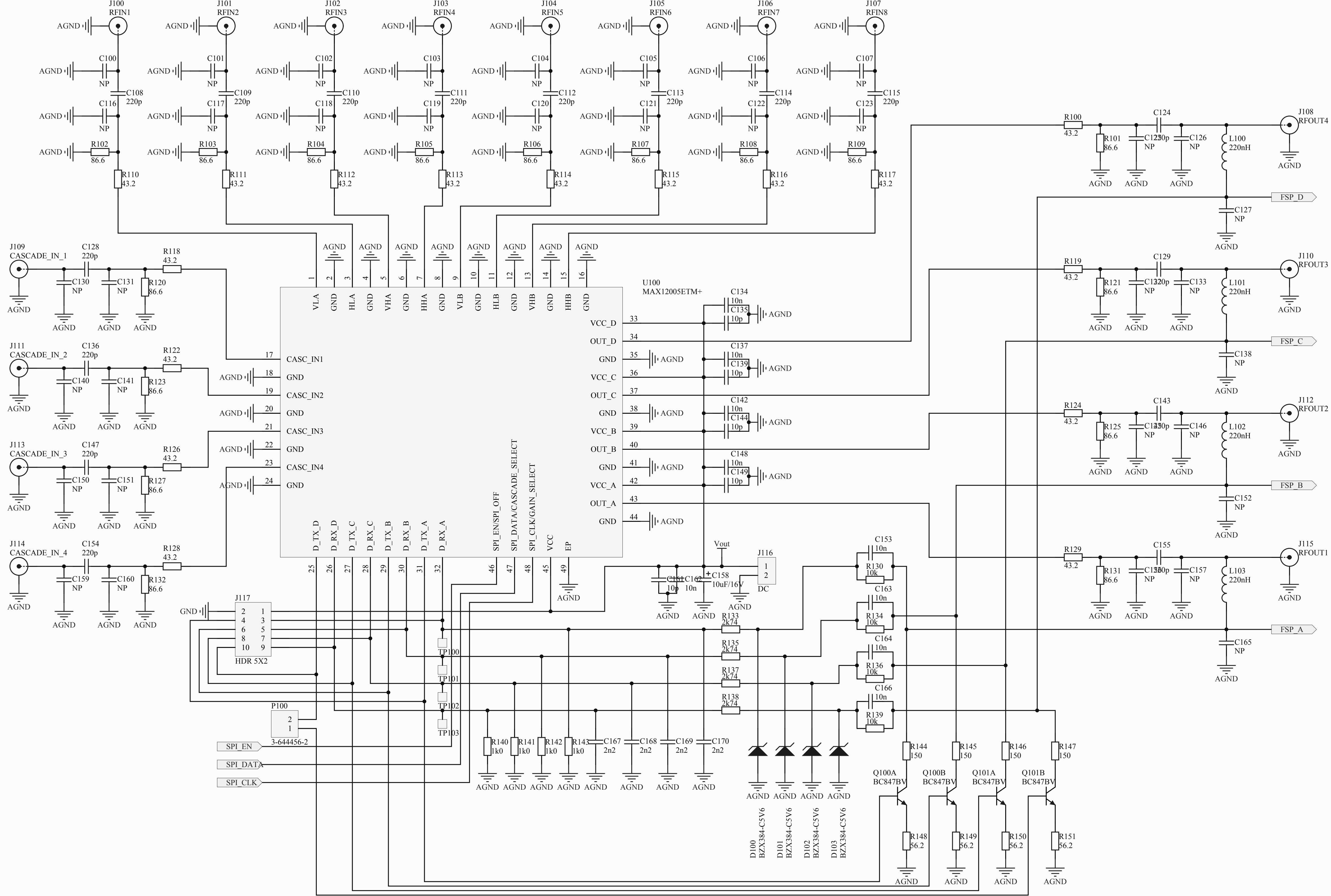

P1= SINGLE MODE  
P2= MASTER MODE  
P3= SLAVE MODE  
P4= LNB MODE

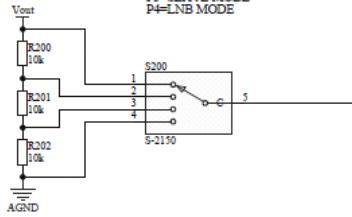

P1=13dB  
P2=6dB  
P3=0dB

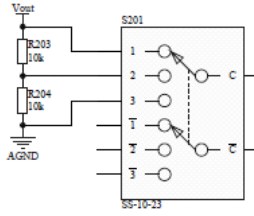

P1=SPI\_OFF  
P2=SPI\_ON

