

171692-0110

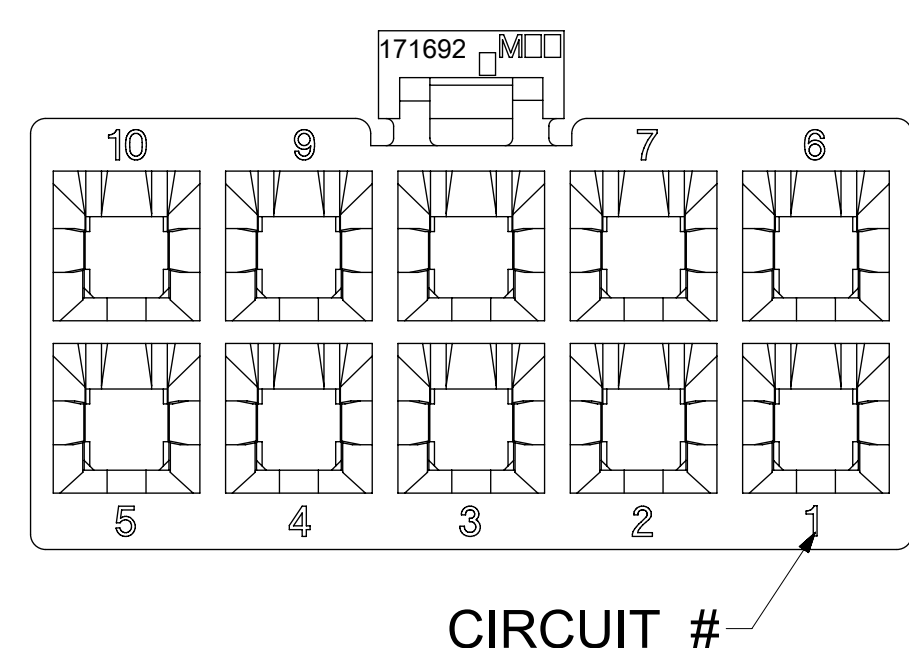
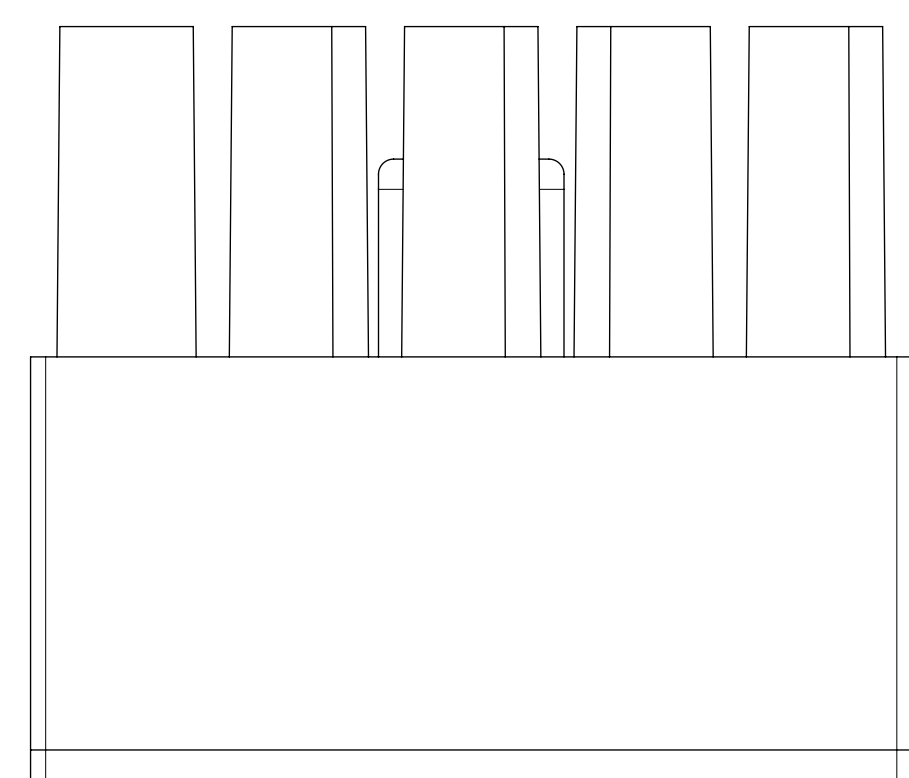
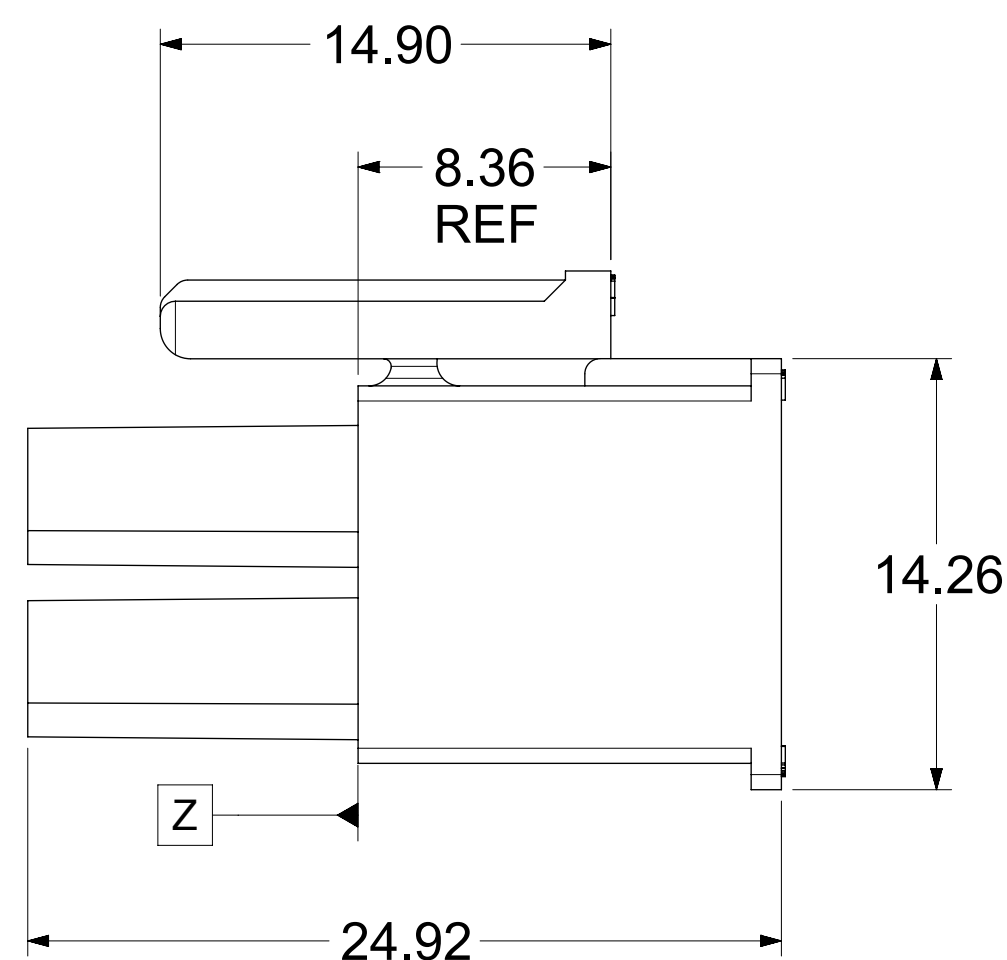
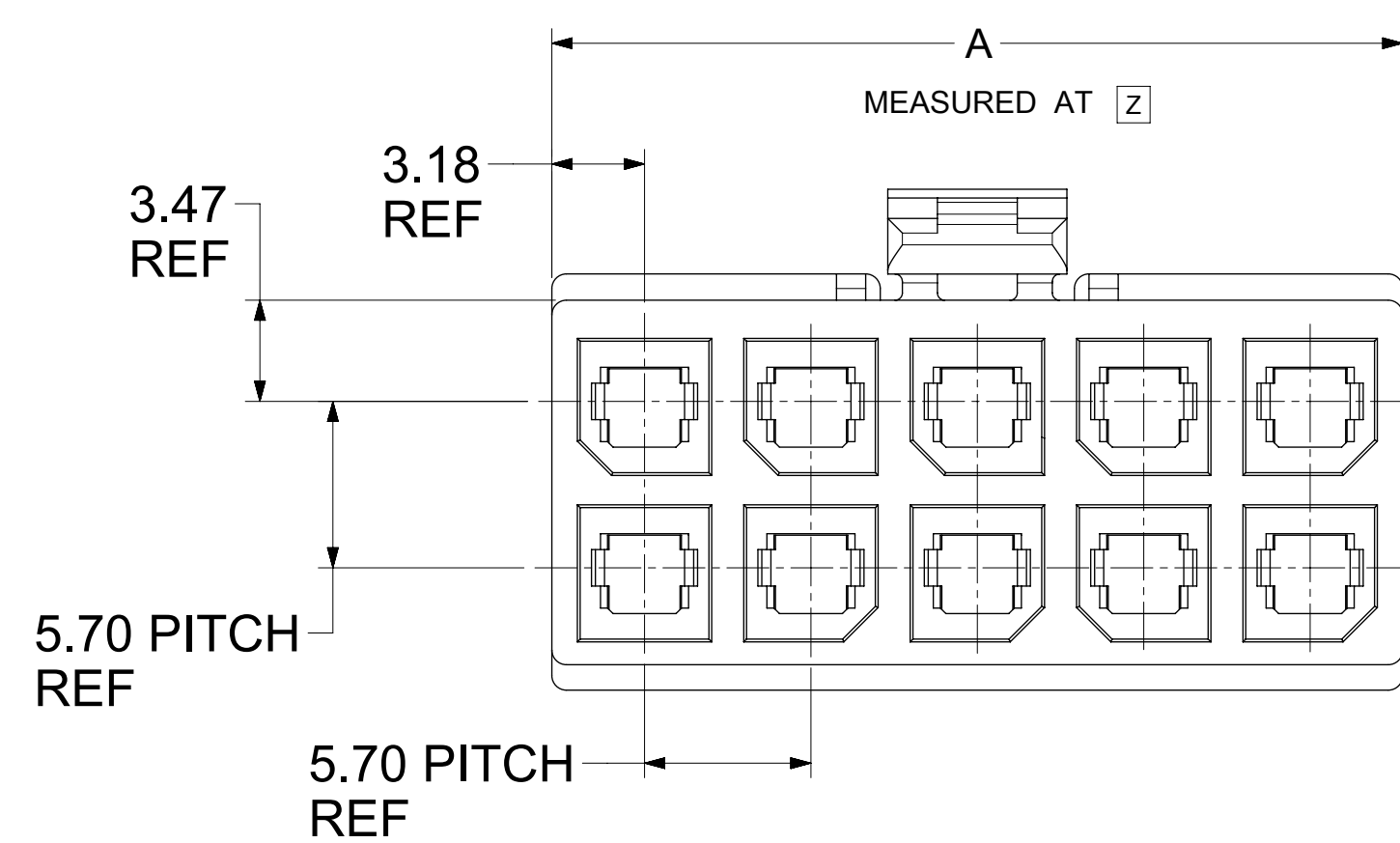

CIRCUIT #

CKT NO	PART NO	DIM A
2	171692-0102	8.35
4	171692-0104	12.05
6	171692-0106	17.75
8	171692-0108	23.45±0.40
10	171692-0110	29.15±0.40
12	171692-0112	34.85±0.40

NOTES:

- MATERIAL:
HOUSING: PBT, UL 94V-0, COLOR: BLACK.
- FINISH: NOT APPLICABLE.
- PRODUCT SPECIFICATION: PS-76823-100.
- PACKAGING: BULK PACK PER PK-170001-001
- PART MATES WITH MOLEX SERIES NUMBERS 76825, 76829, 172064, AND 172065.
- PART IS FOR USE WITH MOLEX FEMALE TERMINAL 76823 OR 172063 SERIES.
- APPLICATION SPECIFICATION: AS-76823-100.
- PARTS CONFORM TO CLASS B REQUIREMENTS OF COSMETIC SPECIFICATION PS-45499-002 WITH THE EXCEPTION OF DISCOLORATION AND SINK MEETS CLASS "C" REQUIREMENTS.

THIS DRAWING CONTAINS INFORMATION THAT IS PROPRIETARY TO MOLEX ELECTRONIC TECHNOLOGIES, LLC AND SHOULD NOT BE USED WITHOUT WRITTEN PERMISSION											
DIMENSION UNITS		SCALE		CURRENT REV DESC:							
mm		NTS									
GENERAL TOLERANCES (UNLESS SPECIFIED)											
ANGULAR TOL ± 0.5°											
4 PLACES ±				EC NO: 716347							
3 PLACES ±				DRWN: JERRYW8 2022/08/01							
2 PLACES ± 0.25				CHK'D: XQZHANG 2022/08/18							
1 PLACE ±				APPR: XQZHANG 2022/08/18							
0 PLACES ±				INITIAL REVISION:							
DRAFT WHERE APPLICABLE MUST REMAIN WITHIN DIMENSIONS				THIRD ANGLE PROJECTION		DRAWING		SERIES		MATERIAL NUMBER	
				D-SIZE		171692		SEE CHART		CUSTOMER	
								GENERAL MARKET		SHEET NUMBER	
								1 OF 2			

molex

MEGA-FIT RECEPTACLE HOUSING 2-12 CKT

PRODUCT CUSTOMER DRAWING

DOCUMENT NUMBER	DOC TYPE	DOC PART	REVISION
SD-171692-0100	PSD	001	C1

2 CKTS

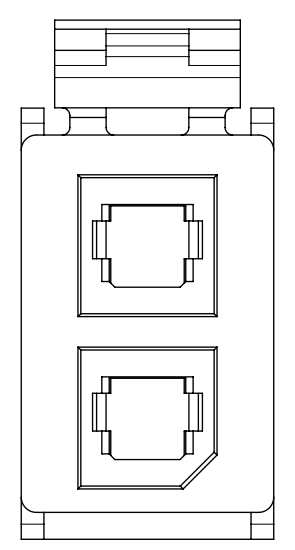

4 CKT

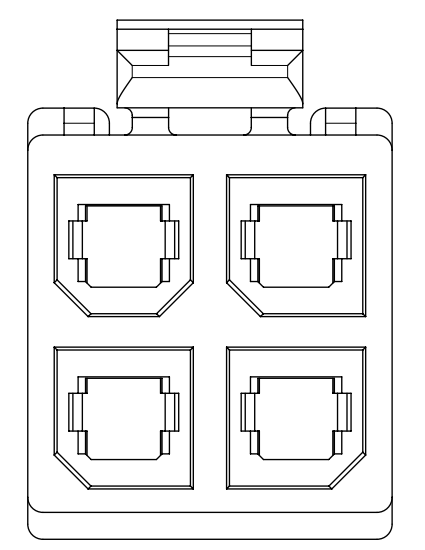

6 CKT

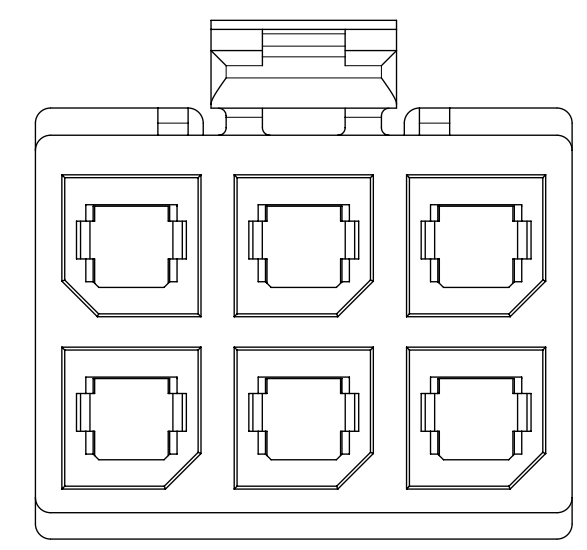

8 CKT

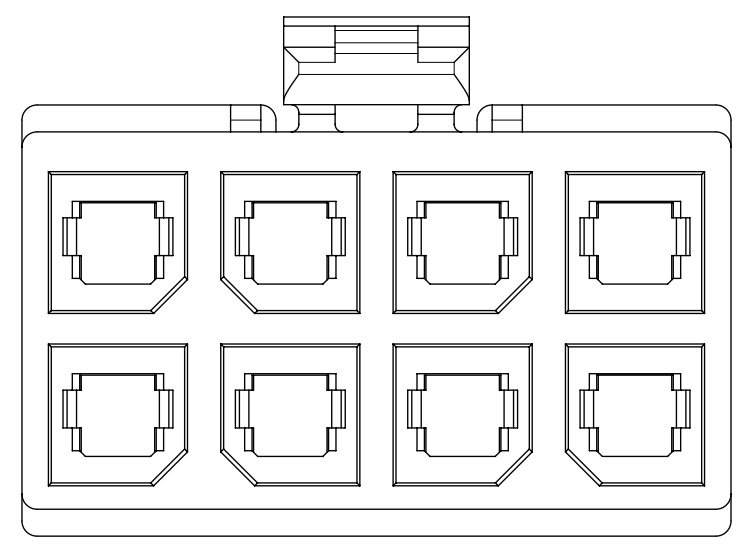

10 CKTS

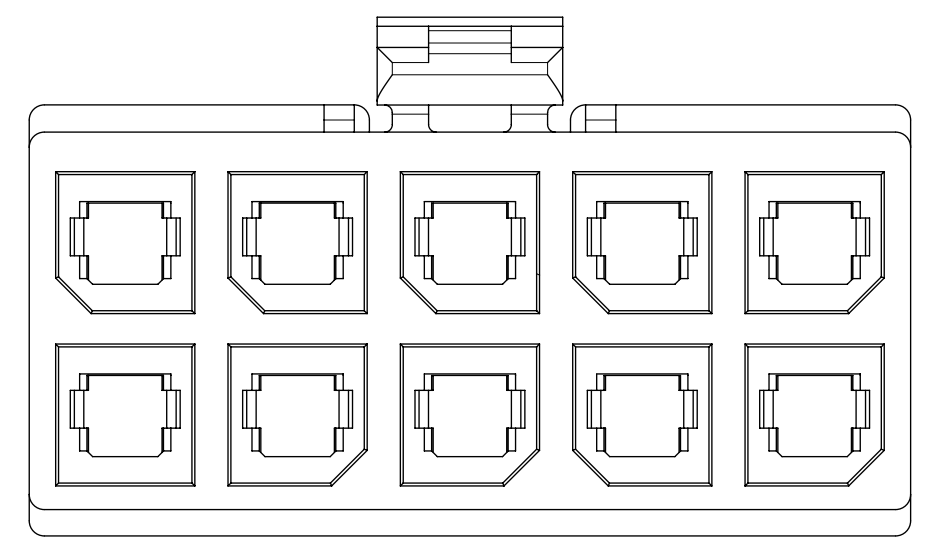

12 CKTS

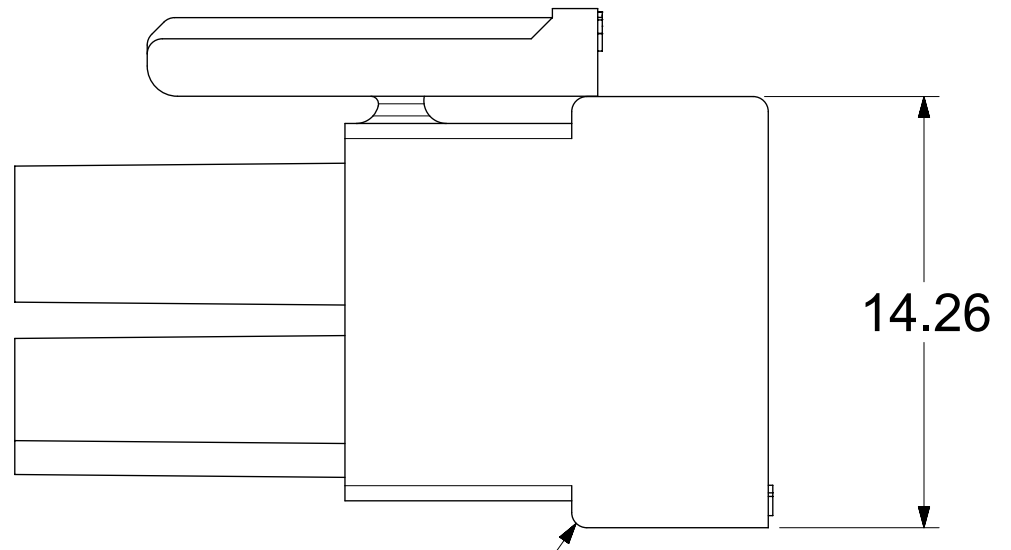
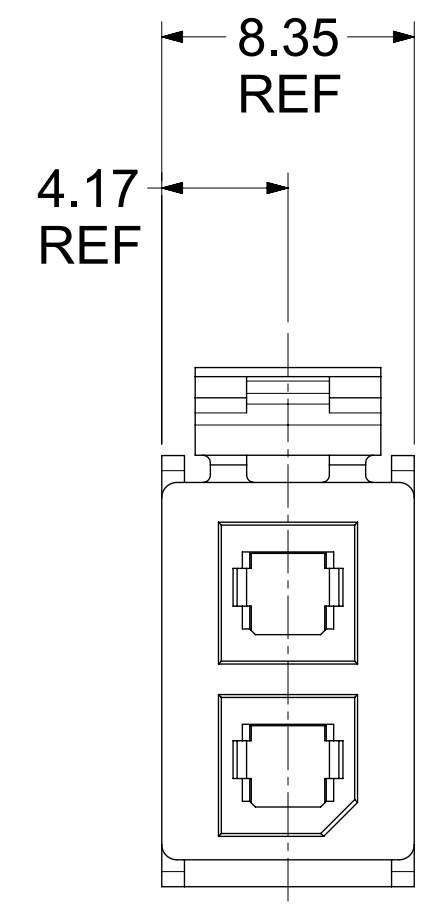
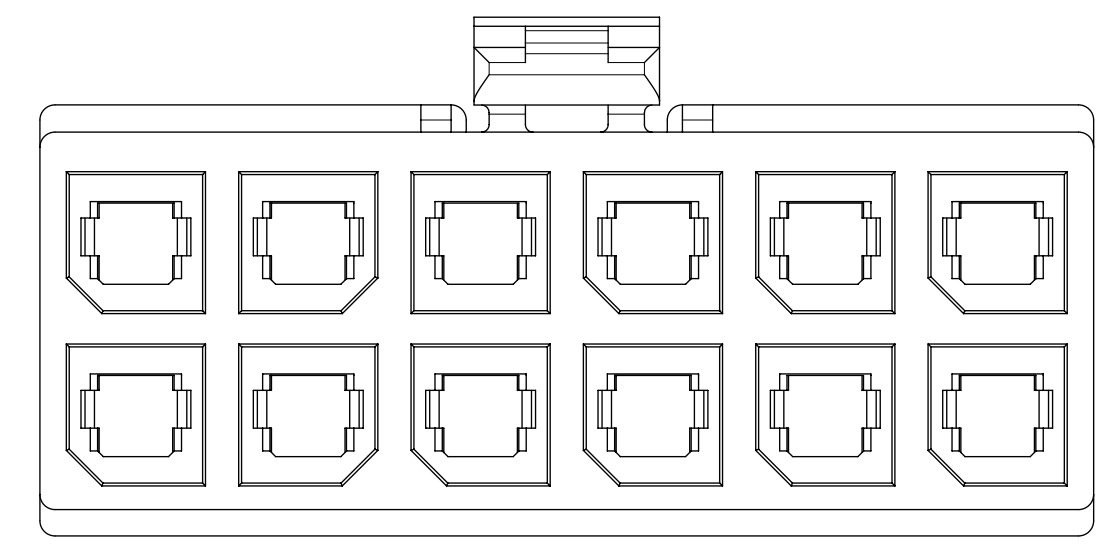

BOTTOM RIB ON
2 CKT ONLY

171692-0102

THIS DRAWING CONTAINS INFORMATION THAT IS PROPRIETARY TO MOLEX ELECTRONIC TECHNOLOGIES, LLC AND SHOULD NOT BE USED WITHOUT WRITTEN PERMISSION											
DIMENSION UNITS		SCALE		CURRENT REV DESC:						molex	
mm		NTS									
GENERAL TOLERANCES (UNLESS SPECIFIED)				EC NO: 716347						MEGA-FIT RECEPTACLE HOUSING 2-12 CKT	
ANGULAR TOL ± 0.5°				DRWN: JERRYW8 2022/08/01							
4 PLACES ±				CHK'D: XQZHANG 2022/08/18						PRODUCT CUSTOMER DRAWING	
3 PLACES ±				APPR: XQZHANG 2022/08/18							
2 PLACES ± 0.25				INITIAL REVISION:						DOCUMENT NUMBER	
1 PLACE ±				DRWN: MKARADIMAS 2012/08/01							
0 PLACES ±				APPR: APATEL 2012/08/17						REVISION	
DRAFT WHERE APPLICABLE MUST REMAIN WITHIN DIMENSIONS				THIRD ANGLE PROJECTION		DRAWING		SERIES		CUSTOMER	
						D-SIZE		171692		SEE CHART	
								GENERAL MARKET		SHEET NUMBER	
								2 OF 2			