

L0805C2R7KSMST

Aliases (L0805C2R7KSMST)

Obsolete

KEMET, L-SMS, Commercial Grade, 2.7 uH, 10%

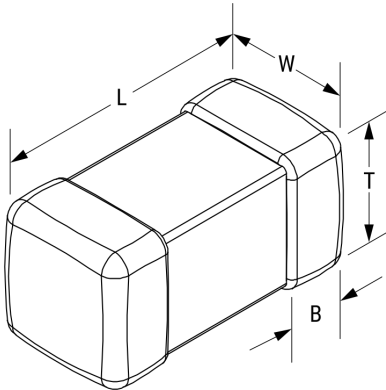

Click [here](#) for the 3D model.

Dimensions

Chip Size	0805
L	2mm +0.3/-0.1mm
W	1.25mm +/-0.2mm
T	1.25mm +/-0.2mm
LL	0.5mm +/-0.2mm
B	0.5mm +/-0.2mm

Packaging Specifications

Packaging	T&R
Packaging Quantity	2000

General Information

Series	L-SMS
Style	SMD Chip
Description	Shielded, Surface Mount Inductor
Features	Standard Type
RoHS	Yes
Core	Ceramic
Winding Type	Multilayer
Notes	Suggested Replacement - https://www.chilisin.com/en-global/Inductor/Product/BSCL_201212/BSCL002012122R7K00 .

Specifications

Inductance	2.7 uH
Inductance Tolerance	10%
Temperature Range	-40/+85°C
Current	30 mAmps (MAX)
DC Resistance	0.75 Ohms
Quality Factor	45 at 10 MHz
Self-Resonant Frequency	45 MHz