

EPC2106 – Enhancement-Mode GaN Power Transistor Half-Bridge

V_{DS} , 100 V

$R_{DS(on)}$, 70 mΩ

I_D , 1.7 A

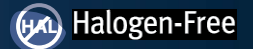

Gallium Nitride’s exceptionally high electron mobility and low temperature coefficient allows very low $R_{DS(on)}$, while its lateral device structure and majority carrier diode provide exceptionally low Q_G and zero Q_{RR} . The end result is a device that can handle tasks where very high switching frequency, and low on-time are beneficial as well as those where on-state losses dominate.

Maximum Ratings				
DEVICE	PARAMETER		VALUE	UNIT
Q1 & Q2	V_{DS}	Drain-to-Source Voltage (Continuous)	100	V
		Drain-to-Source Voltage (up to 10,000 5 ms pulses at 150°C)	120	
	I_D	Continuous ($T_A = 25^\circ\text{C}$, $R_{\theta JA} = 320^\circ\text{C/W}$)	1.7	A
		Pulsed (25°C , $T_{PULSE} = 300 \mu\text{s}$)	18	
	V_{GS}	Gate-to-Source Voltage	6	V
		Gate-to-Source Voltage	-4	
	T_J	Operating Temperature	-40 to 150	°C
	T_{STG}	Storage Temperature	-40 to 150	

Thermal Characteristics			
PARAMETER		TYP	UNIT
$R_{\theta JC}$	Thermal Resistance, Junction-to-Case	3	°C/W
$R_{\theta JB}$	Thermal Resistance, Junction-to-Board	30	
$R_{\theta JA}$	Thermal Resistance, Junction-to-Ambient (Note 1)	81	

Note 1: $R_{\theta JA}$ is determined with the device mounted on one square inch of copper pad, single layer 2 oz copper on FR4 board. See https://epc-co.com/epc/documents/product-training/Appnote_Thermal_Performance_of_eGaN_FETs.pdf for details

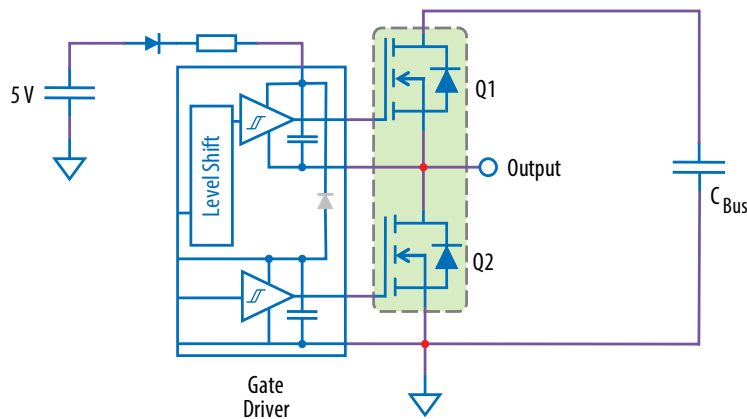

Typical Application Circuit

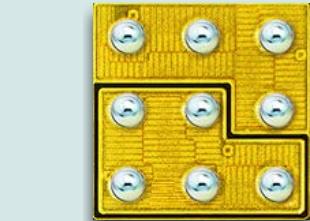

EPC2106 eGaN® ICs are supplied only in passivated die form with solder bumps
Die size: 1.35 mm x 1.35 mm

Applications

- High Frequency DC-DC Conversion
- Class-D Audio

Benefits

- Ultra High Efficiency
- Ultra Low $R_{DS(on)}$
- Ultra Low Q_G
- Ultra Small Footprint

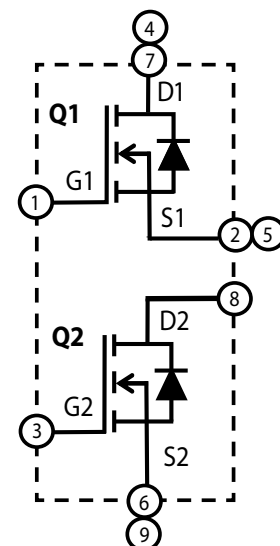

EPC2106 – Detailed Schematic

Static Characteristics ($T_J = 25^\circ\text{C}$ unless otherwise stated)

DEVICE	PARAMETER		TEST CONDITIONS	MIN	TYP	MAX	UNIT
Q1 & Q2	BV_{DSS}	Drain-to-Source Voltage	$V_{GS} = 0\text{ V}, I_D = 0.3\text{ mA}$	100			V
	I_{DSS}	Drain-Source Leakage	$V_{DS} = 80\text{ V}, V_{GS} = 0\text{ V}$		0.001	0.25	mA
	I_{GSS}	Gate-to-Source Forward Leakage	$V_{GS} = 5\text{ V}$		0.01	1	mA
		Gate-to-Source Reverse Leakage	$V_{GS} = -4\text{ V}$		0.001	0.25	mA
	$V_{GS(TH)}$	Gate Threshold Voltage	$V_{DS} = V_{GS}, I_D = 0.6\text{ mA}$	0.8	1.4	2.5	V
	$R_{DS(on)}$	Drain-Source On Resistance	$V_{GS} = 5\text{ V}, I_D = 2\text{ A}$		55	70	m Ω
	V_{SD}	Source-Drain Forward Voltage	$I_S = 0.35\text{ A}, V_{GS} = 0\text{ V}$		2.1		V

Dynamic Characteristics ($T_J = 25^\circ\text{C}$ unless otherwise stated)

DEVICE	PARAMETER		TEST CONDITIONS	MIN	TYP	MAX	UNIT
Q1	C_{ISS}	Input Capacitance	$V_{DS} = 50\text{ V}, V_{GS} = 0\text{ V}$		79	95	pF
	C_{RSS}	Reverse Transfer Capacitance			0.5		
	C_{OSS}	Output Capacitance			52	78	
	$C_{OSS(ER)}$	Effective Output Capacitance, Energy Related (Note 2)	$V_{DS} = 0\text{ to }50\text{ V}, V_{GS} = 0\text{ V}$		63		
	$C_{OSS(TR)}$	Effective Output Capacitance, Time Related (Note 3)			79		
	R_G	Gate Resistance			1.3		Ω
	Q_G	Total Gate Charge	$V_{DS} = 50\text{ V}, V_{GS} = 5\text{ V}, I_D = 2\text{ A}$		730	900	pC
	Q_{GS}	Gate to Source Charge	$V_{DS} = 50\text{ V}, I_D = 2\text{ A}$		240		
	Q_{GD}	Gate to Drain Charge			140		
	$Q_{G(TH)}$	Gate Charge at Threshold			165		
	Q_{OSS}	Output Charge	$V_{DS} = 50\text{ V}, V_{GS} = 0\text{ V}$		3960	5940	
Q_{RR}	Source-Drain Recovery Charge			0			
Q2	C_{ISS}	Input Capacitance	$V_{DS} = 50\text{ V}, V_{GS} = 0\text{ V}$		79	95	pF
	C_{RSS}	Reverse Transfer Capacitance			0.5		
	C_{OSS}	Output Capacitance			61	92	
	$C_{OSS(ER)}$	Effective Output Capacitance, Energy Related (Note 2)	$V_{DS} = 0\text{ to }50\text{ V}, V_{GS} = 0\text{ V}$		74		
	$C_{OSS(TR)}$	Effective Output Capacitance, Time Related (Note 3)			94		
	R_G	Gate Resistance			1.8		Ω
	Q_G	Total Gate Charge	$V_{DS} = 50\text{ V}, V_{GS} = 5\text{ V}, I_D = 2\text{ A}$		730	900	pC
	Q_{GS}	Gate to Source Charge	$V_{DS} = 50\text{ V}, I_D = 2\text{ A}$		240		
	Q_{GD}	Gate to Drain Charge			140		
	$Q_{G(TH)}$	Gate Charge at Threshold			165		
	Q_{OSS}	Output Charge	$V_{DS} = 50\text{ V}, V_{GS} = 0\text{ V}$		4680	7020	
Q_{RR}	Source-Drain Recovery Charge			0			

Note 2: $C_{OSS(ER)}$ is a fixed capacitance that gives the same stored energy as C_{OSS} while V_{DS} is rising from 0 to 50% BV_{DSS} .

Note 3: $C_{OSS(TR)}$ is a fixed capacitance that gives the same charging time as C_{OSS} while V_{DS} is rising from 0 to 50% BV_{DSS} .

Figure 1 (Q1 & Q2): Typical Output Characteristics at 25°C

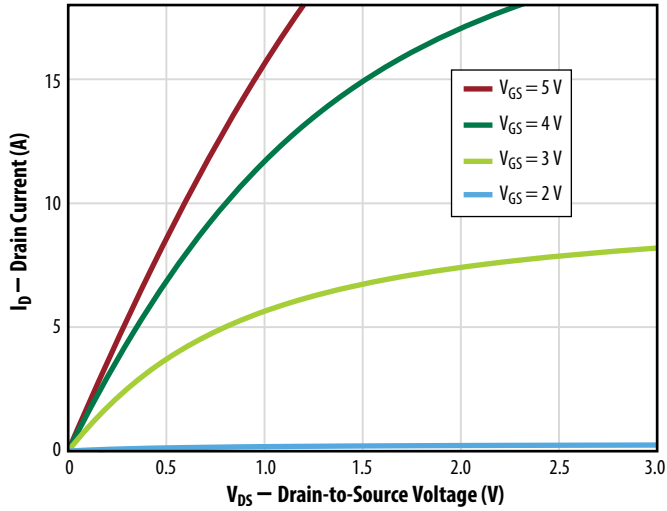

Figure 2 (Q1 & Q2): Transfer Characteristics

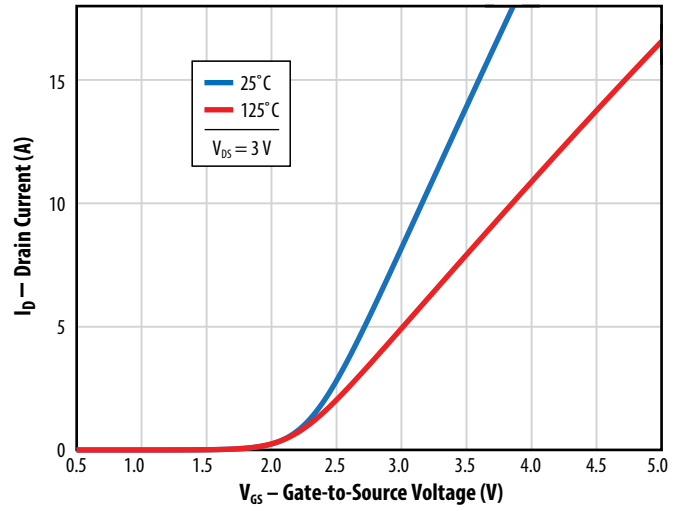

Figure 3 (Q1 & Q2): $R_{DS(on)}$ vs. V_{GS} for Various Drain Currents

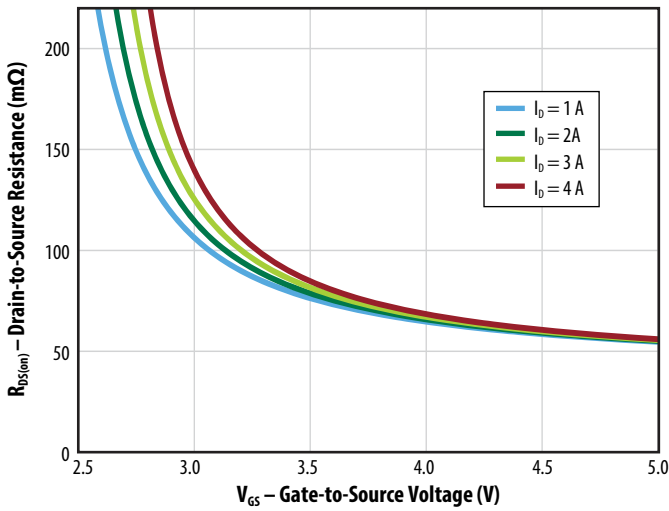

Figure 4 (Q1 & Q2): $R_{DS(on)}$ vs. V_{GS} for Various Temperatures

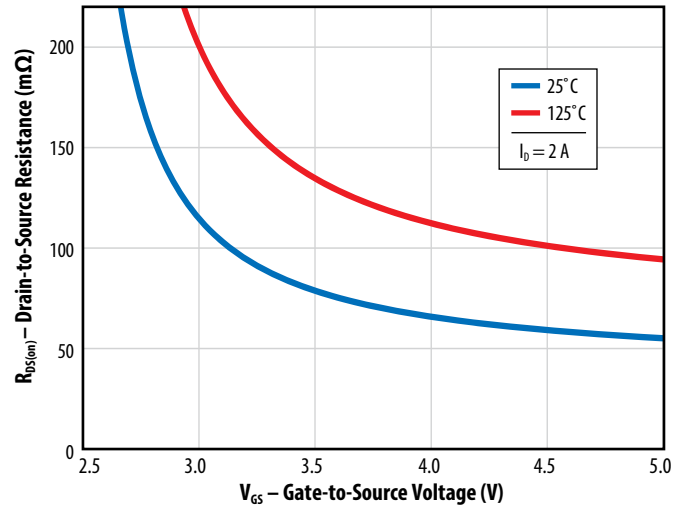

Figure 5a (Q1): Capacitance (Linear Scale)

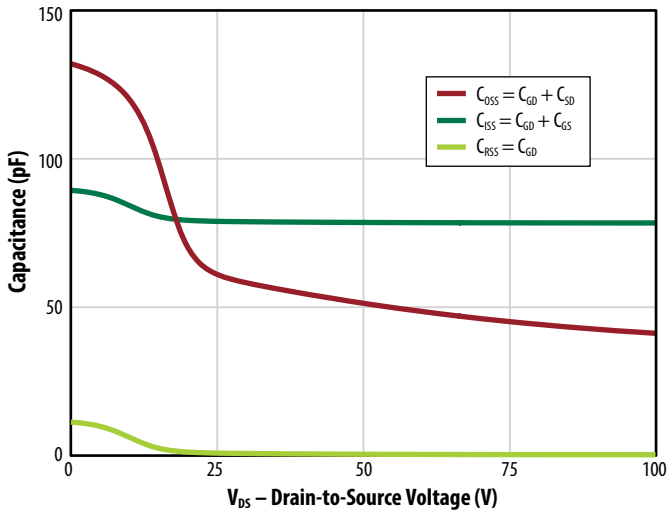

Figure 5b (Q1): Capacitance (Log Scale)

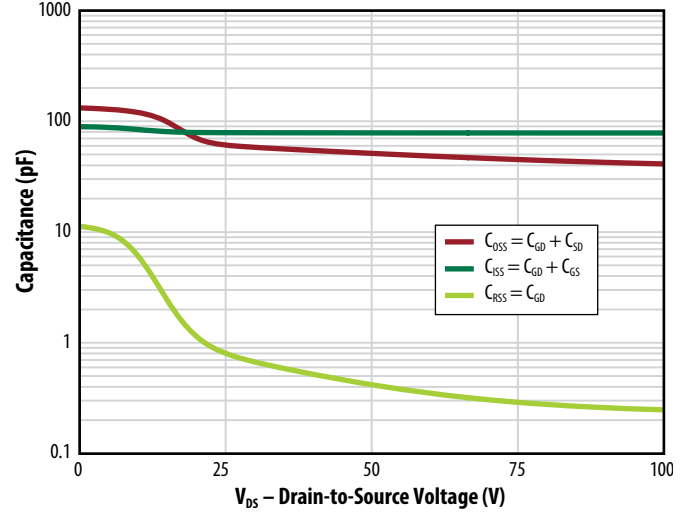

Figure 5c (Q2): Capacitance (Linear Scale)

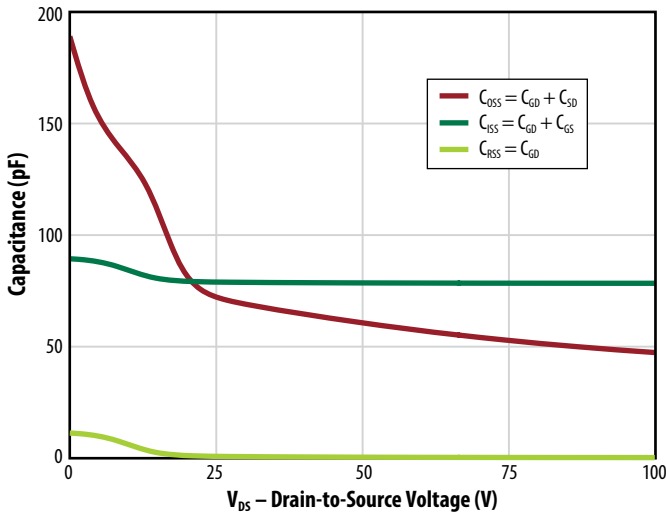

Figure 5d (Q2): Capacitance (Log Scale)

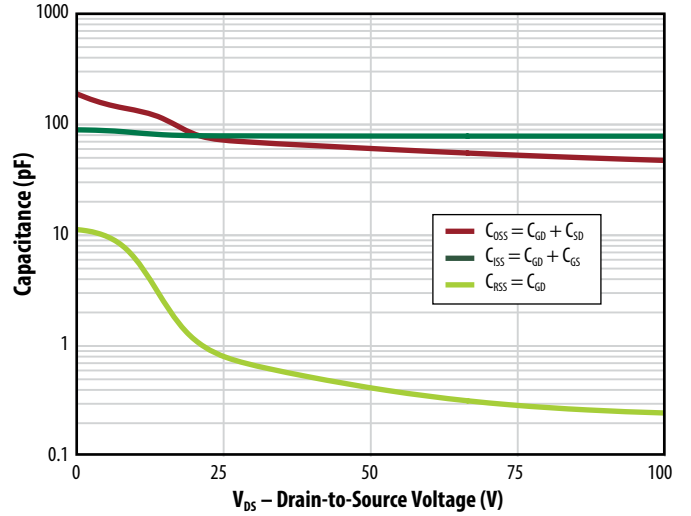

Figure 6a (Q1): Output Charge and C_oss Stored Energy

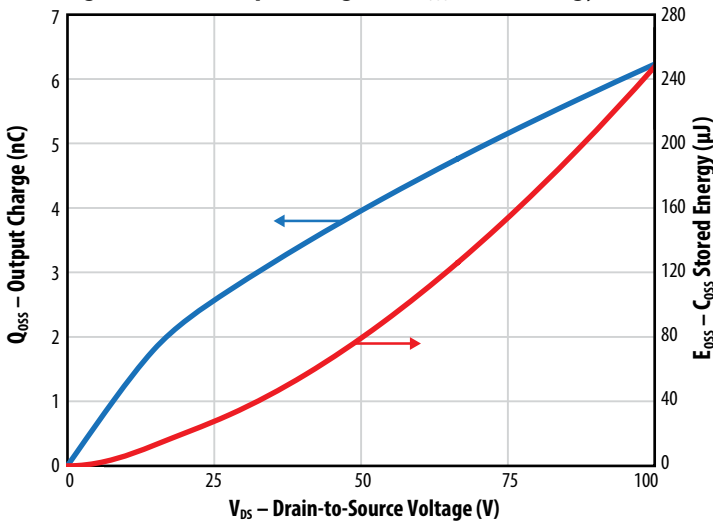

Figure 6b (Q2): Output Charge and C_oss Stored Energy

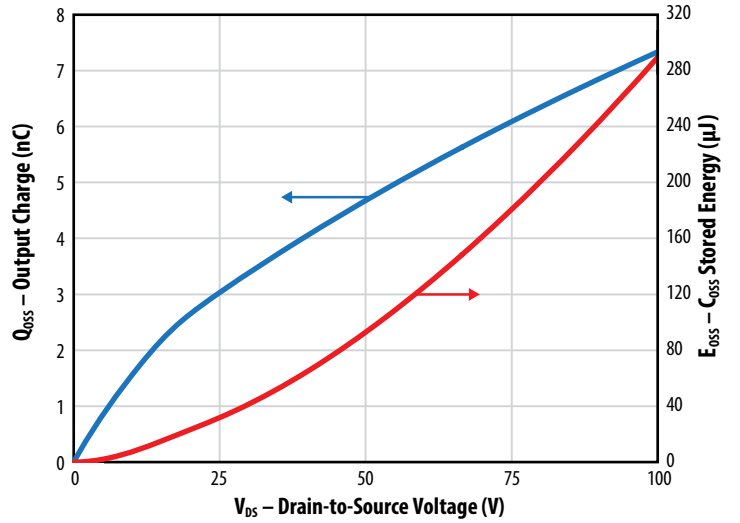

Figure 7 (Q1 & Q2): Gate Charge

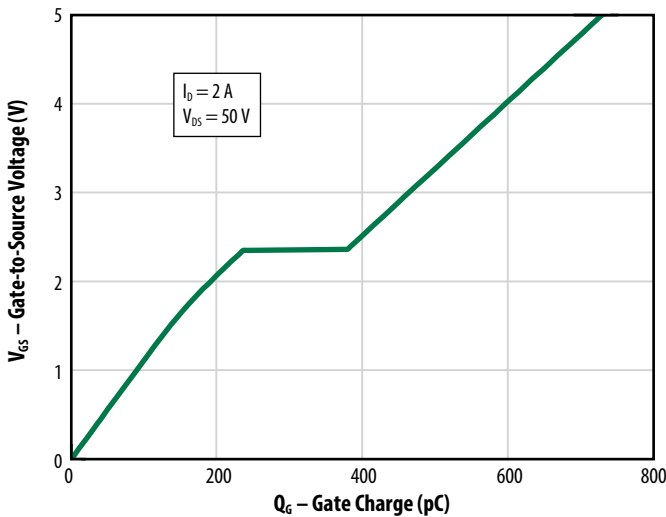

Figure 8 (Q1 & Q2): Reverse Drain-Source Characteristics

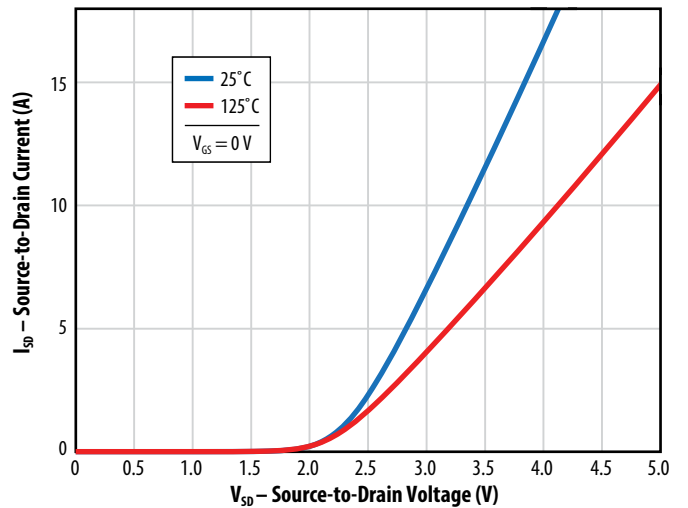

Figure 9 (Q1 & Q2):
Normalized On-State Resistance vs. Temperature

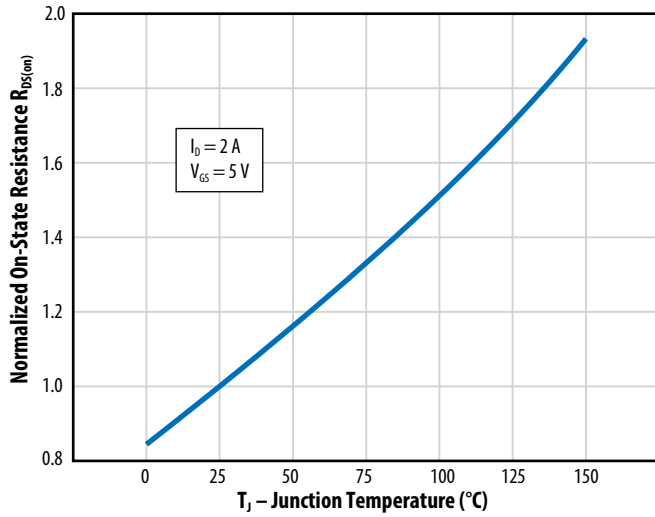
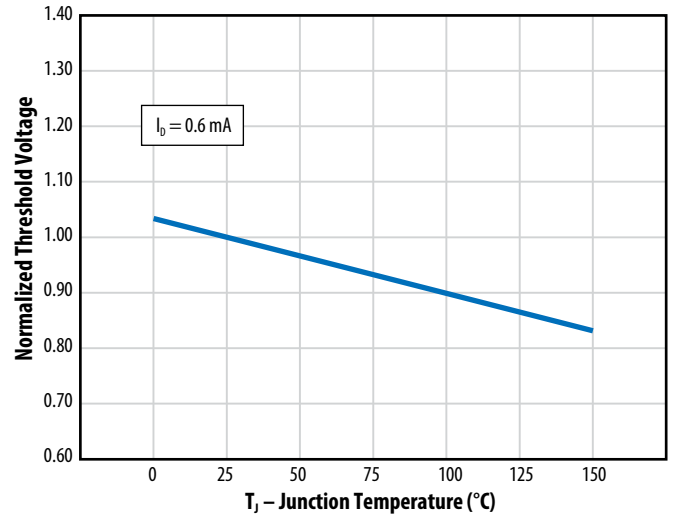
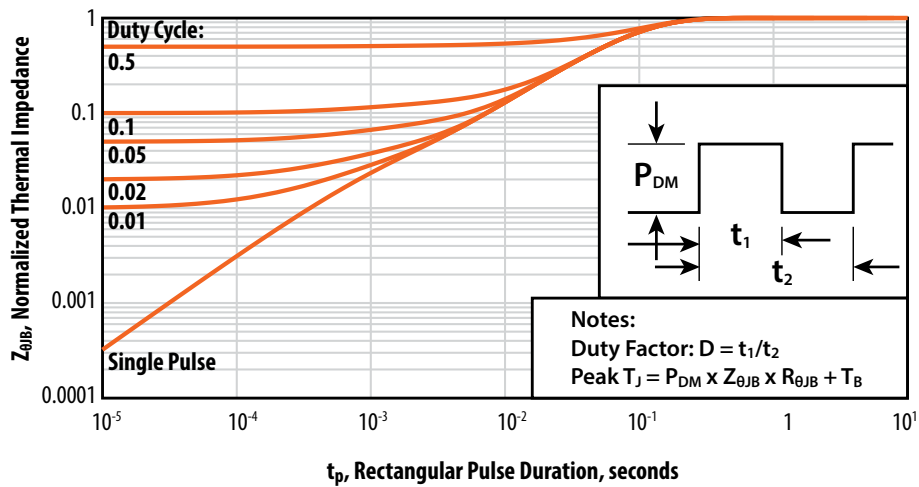

Figure 10 (Q1 & Q2):
Normalized Threshold Voltage vs. Temperature



(Q1 & Q2) Junction-to-Board



(Q1 & Q2) Junction-to-Case

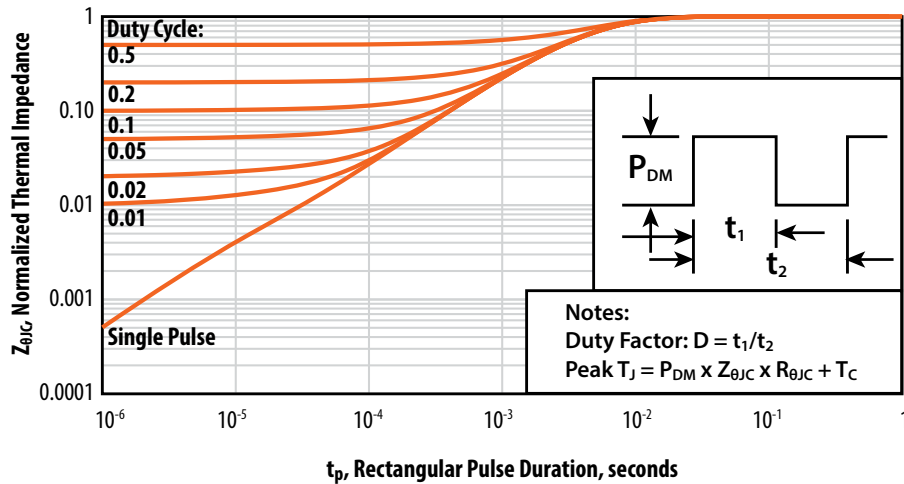
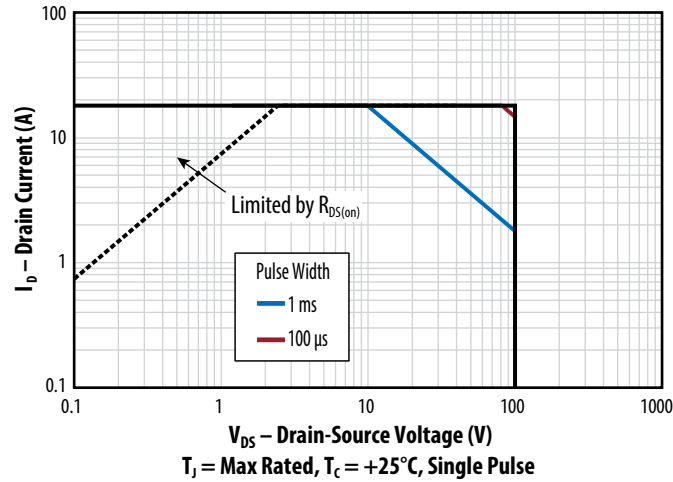
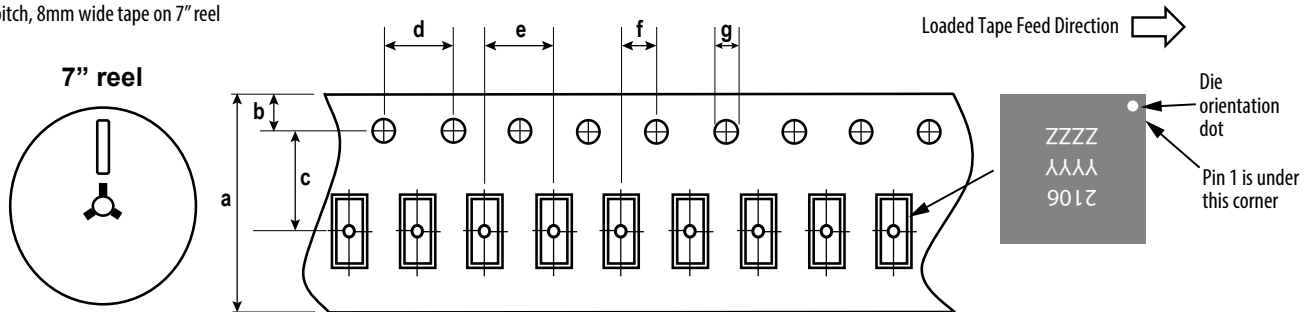

Figure 12 (Q1 & Q2): Safe Operating Area



TAPE AND REEL CONFIGURATION

4mm pitch, 8mm wide tape on 7" reel



Dimension (mm)	EPC2106 (note 1)		
	target	min	max
a	8.00	7.90	8.30
b	1.75	1.65	1.85
c (see note)	3.50	3.45	3.55
d	4.00	3.90	4.10
e	4.00	3.90	4.10
f (see note)	2.00	1.95	2.05
g	1.5	1.5	1.6

Die is placed into pocket solder bump side down (face side down)

Note 1: MSL 1 (moisture sensitivity level 1) classified according to IPC/JEDEC industry standard.
 Note 2: Pocket position is relative to the sprocket hole measured as true position of the pocket, not the pocket hole.

DIE MARKINGS

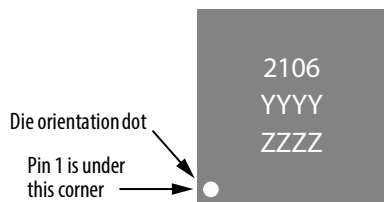

Part Number	Laser Markings		
	Part # Marking Line 1	Lot_Date Code Marking Line 2	Lot_Date Code Marking Line 3
EPC2106	2106	YYYY	ZZZZ

DIE OUTLINE

Solder Bump View

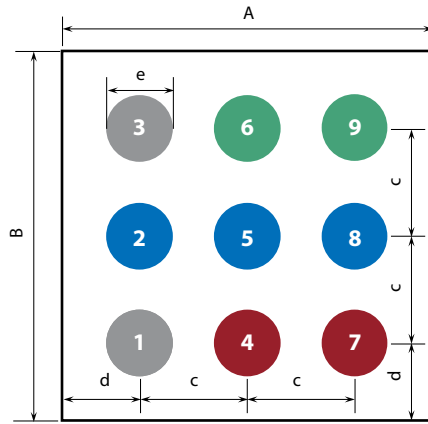

Pad 1 is Gate1 (high side)
 Pad 3 is Gate2 (low side)
 Pads 4, 7 are V_m
 Pads 2, 5, 8 are Switch Node
 Pads 6, 9 are Ground

DIM	Micrometers		
	MIN	Nominal	MAX
A	1320	1350	1380
B	1320	1350	1380
c	450	450	450
d	210	225	240
e	187	208	229

Side View

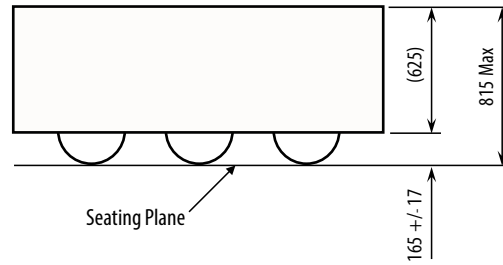

RECOMMENDED LAND PATTERN

(measurements in μm)

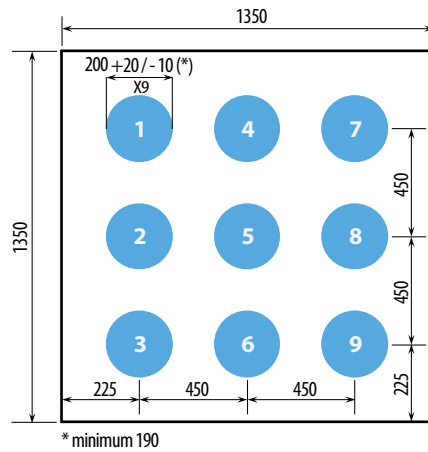

The land pattern is solder mask defined
 Solder mask is 10 μm smaller per side than bump

RECOMMENDED STENCIL DRAWING

(measurements in μm)

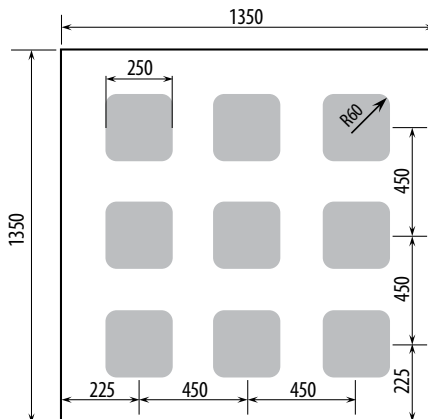

Recommended stencil should be 4 mil (100 μm) thick, must be laser cut, openings per drawing.

Intended for use with SAC305 Type 4 solder, reference 88.5% metals content.

Additional assembly resources available at
<https://epc-co.com/epc/DesignSupport/AssemblyBasics.aspx>

Efficient Power Conversion Corporation (EPC) reserves the right to make changes without further notice to any products herein to improve reliability, function or design. EPC does not assume any liability arising out of the application or use of any product or circuit described herein; neither does it convey any license under its patent rights, nor the rights of others.

eGaN® is a registered trademark of Efficient Power Conversion Corporation.
 EPC Patent Listing: epc-co.com/epc/AboutEPC/Patents.aspx

Information subject to change without notice.

Revised January, 2021