

MATERIAL NO.	ENGINEERING NO.	LENGTH	POLES
1206144007	LW03007C02M020	78.7 (2M)	3
1206144008	LW04007C02M020	78.7 (2M)	4

NOTICE: THIS PART IS CSA AND FACTORY MUTUAL APPROVED  
NO CHANGES CAN BE MADE TO THE ASSEMBLY, COMPONENTS  
OR SUPPLIER WITHOUT PRIOR APPROVAL FROM CSA AND  
FACTORY MUTUAL.

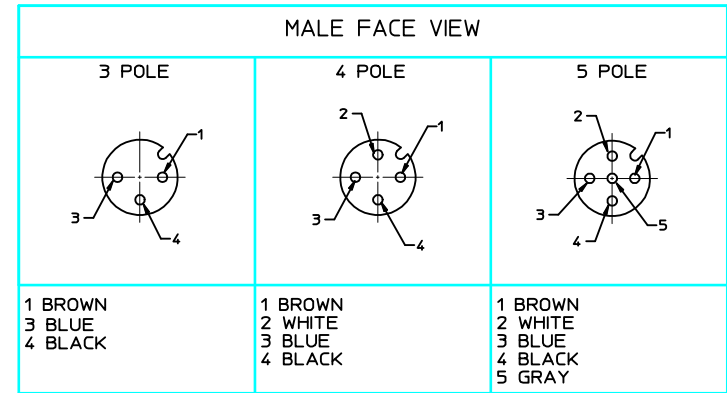
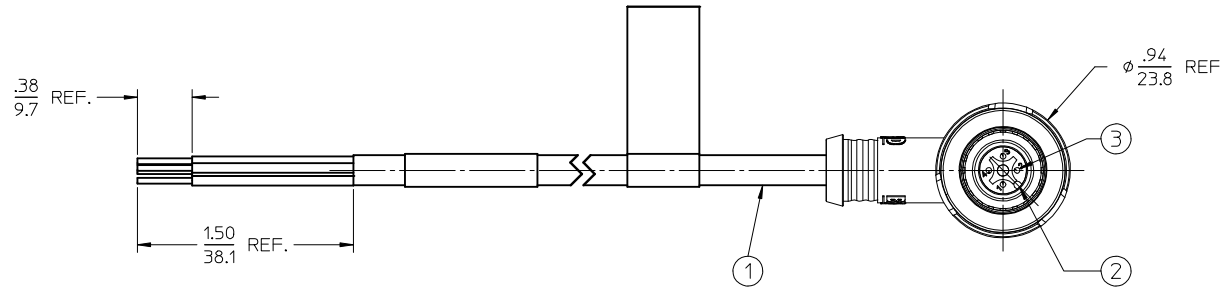
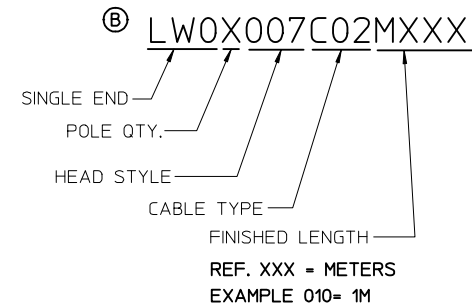
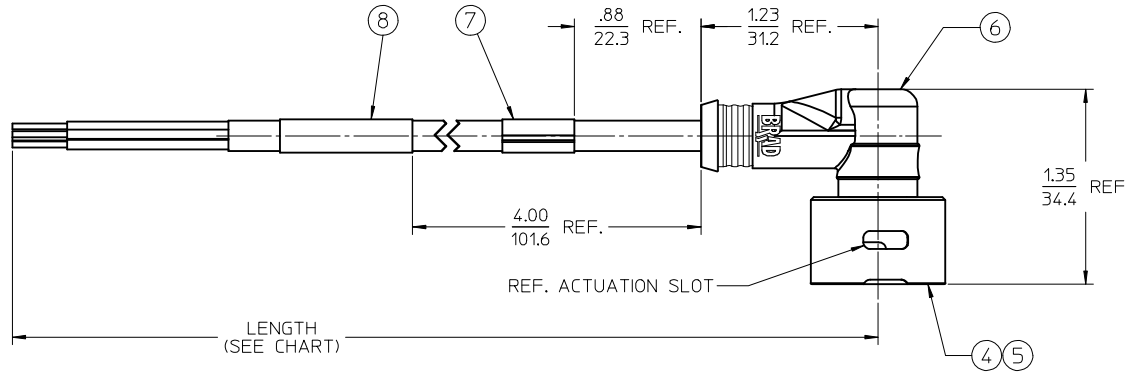
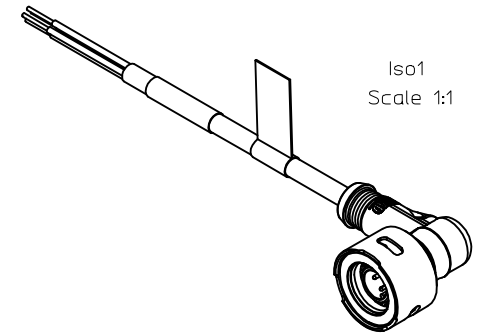

8	1	WRAP LABEL	PLASTIC FILM	BLACK/YELLOW
7	1	FLAG LABEL (WARNING)	POLYESTER	BLACK/ORANGE
6	1	OVERMOLD	TPE	YELLOW
5	1	OUTER SLEEVE	ST. STEEL	PASSIVATED
4	1	INNER SLEEVE	ST. STEEL	PASSIVATED
3	XX	CONTACT	Cu ALLOY	GOLD PLATED
2	1	INSERT	PUR	BLACK
1	1	CABLE, #18 AWG, SJ00W	NEOPRENE	YELLOW
ITEM	QTY.	DESCRIPTION	MATERIAL	FINISH

REV	DESCRIPTION
B	ADDED P/N LEGEND

QUALITY SYMBOLS	
	=0
	=0

GENERAL TOLERANCES (UNLESS SPECIFIED)	
4 PLACES	$\pm$ ---
3 PLACES	$\pm$ ---
2 PLACES	$\pm$ .01
1 PLACE	$\pm$ ---
ANGULAR $\pm$ 2°	

DIMENSION STYLE		SCALE	DESIGN UNITS	THIRD ANGLE PROJECTION
MM ONLY		1.5:1	METRIC	
DRAWN BY DATE		TITLE		
RSTONE 2011/11/21		ULTRA-LOCK ZONE 2		
CHECKED BY DATE		MALE, 90 DEGREE		
L.HARTMANN 2012/01/27		C02, 18 AWG, SJ00W		
APPROVED BY DATE		MOLEX INCORPORATED		
JFMURPHY 2012/04/18		MOLEX INCORPORATED		
MATERIAL NO.		DOCUMENT NO.		SHEET NO.
SEE CHART		SD-120614-018		1 OF 1
THIS DRAWING CONTAINS INFORMATION THAT IS PROPRIETARY TO MOLEX INCORPORATED AND SHOULD NOT BE USED WITHOUT WRITTEN PERMISSION				

CLASS 1, DIVISION 2, GROUP A, B, C, OR D  
HAZARDOUS LOCATION

NON-HAZARDOUS LOCATION

CLASS 1, DIVISION 2, GROUP A, B, C, OR D  
HAZARDOUS LOCATION

NON-HAZARDOUS LOCATION

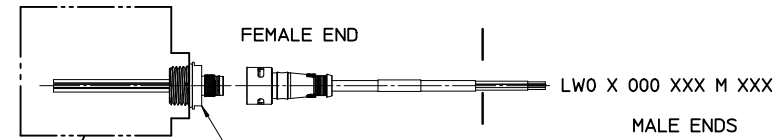

LWR X 006 A18 CXXX  
(MALE 1/2" NPT)  
LWR X A06 A18 CXXX  
(MALE 1/4" NPT)

LW0 X 000 XXX M XXX  
MALE ENDS

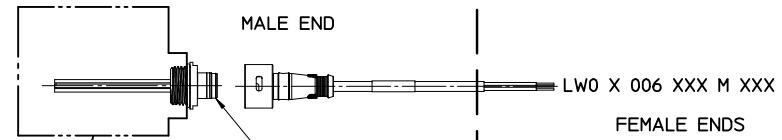
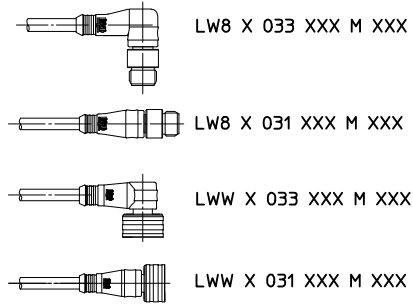
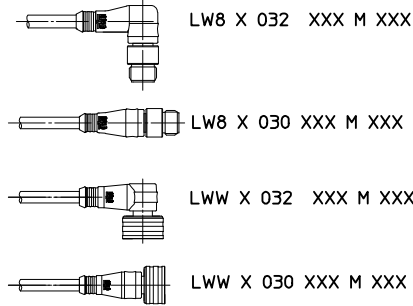

LWR X 000 A18 CXXX  
(FEMALE 1/2" NPT)  
LWR X A00 A18 CXXX  
(FEMALE 1/4" NPT)

LW0 X 006 XXX M XXX  
FEMALE ENDS

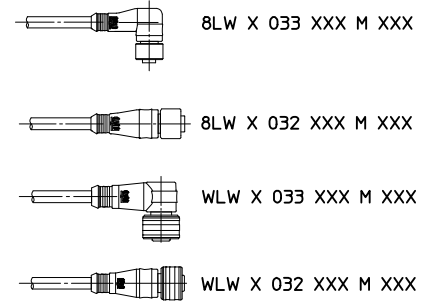
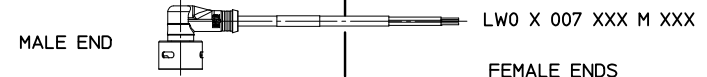
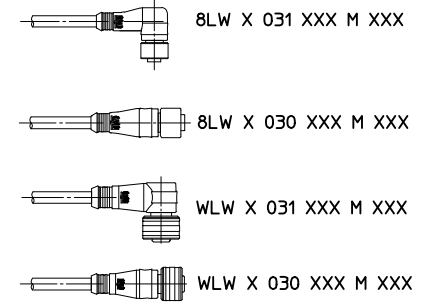

NOTES:

1. THE INSTALLATION MUST BE IN ACCORDANCE WITH THE NATIONAL ELECTRICAL CODE (NEC), ANSI/NFPA 70. SPECIFIC REQUIREMENTS FOR THE INSTALLATION OF ITC RATED CABLE MAY BE FOUND IN ARTICLE 501.4(B)(1)(5) AND ARTICLE 727.4
2. THE MOLDED CONSTRUCTION OF THE CORDSET AND GAS/VAPORTIGHT CONTINUOUS SHEATH OF THE CABLE MEET THE REQUIREMENTS OF THE NEC, ARTICLE 501-5(E)(2) FOR CABLE SEALS IN CLASS 1, DIVISION 2

FIELD DEVICE APPROVAL FOR CLASS 1, DIV. 2 OR CLASS 1, ZONE2 INSTALLATIONS

REF. SEE SHEET 3 FOR CONFIGURATION INFORMATION

NOTICE: THIS PART IS CSA AND FACTORY MUTUAL APPROVED  
NO CHANGES CAN BE MADE TO THE ASSEMBLY, COMPONENTS  
OR SUPPLIER WITHOUT PRIOR APPROVAL FROM CSA AND  
FACTORY MUTUAL.

THIS DRAWING SUPERSEDES ES-120614-001 REV-B

<p>SEE SHEET 3 EC NO: IPG2018-0141 DRAWN BY: DRWINRSTONE 2017/08/28 CHKD: BWOODMAN 2017/08/30 APPR: BWOODMAN 2017/09/06</p>	<p>QUALITY SYMBOLS ▽=0 ▽=0</p>	GENERAL TOLERANCES (UNLESS SPECIFIED)		DIMENSION STYLE IN/MM		SCALE 1:1	DESIGN UNITS INCH	THIRD ANGLE PROJECTION	
				DRAWN BY: RSTONE DATE: 2012/05/18		TITLE CONTROL DOC FOR ULTRA-LOCK ZONE 2			
				CHECKED BY: K JOZWIK DATE: 2012/05/22		MOLEX INCORPORATED			
				APPROVED BY: JFMURPHY DATE: 2012/08/27					
		ANGULAR ±---°		MATERIAL NO. 1206149999		DOCUMENT NO. SD-120614-999		SHEET NO. 1 OF 3	
		DRAFT WHERE APPLICABLE MUST REMAIN WITHIN DIMENSIONS		<p>THIS DRAWING CONTAINS INFORMATION THAT IS PROPRIETARY TO MOLEX INCORPORATED AND SHOULD NOT BE USED WITHOUT WRITTEN PERMISSION</p>					

CLASS 1, DIVISION 2, GROUP A, B, C, OR D  
HAZARDOUS LOCATION

HAZARDOUS LOCATION

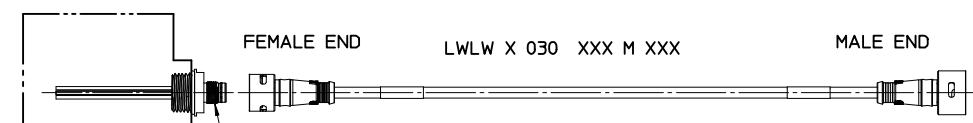

LWR X 006 A18 CXXX  
(MALE 1/2" NPT)  
LWR X A06 A18 CXXX  
(MALE 1/4" NPT)

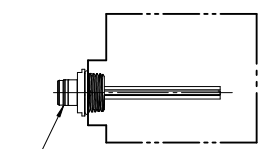

LWR X 000 A18 CXXX  
(FEMALE 1/2" NPT)  
LWR X A00 A18 CXXX  
(FEMALE 1/4" NPT)

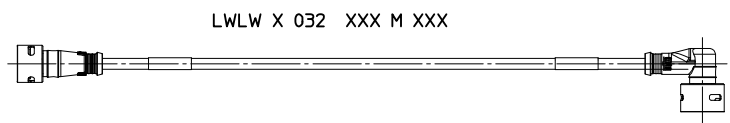

LWLW X 031 XXX M XXX

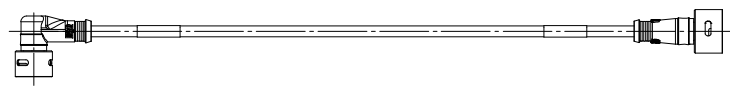

LWLW X 033 XXX M XXX

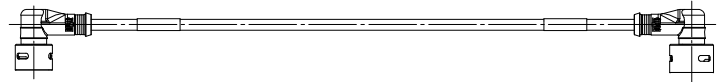

- REF:
1. SEE SHEET 1 FOR NOTES
  2. SEE SHEET 3 FOR CONFIGURATION INFORMATION

NOTICE: THIS PART IS CSA AND FACTORY MUTUAL APPROVED  
NO CHANGES CAN BE MADE TO THE ASSEMBLY, COMPONENTS  
OR SUPPLIER WITHOUT PRIOR APPROVAL FROM CSA AND  
FACTORY MUTUAL.

SEE SHEET 3 EC NO: JFG2018-0141 DRAWNR:STONE 2017/08/28 CHKD:WOODMAN 2017/08/30 APPR:WOODMAN 2017/09/06	QUALITY SYMBOLS ▽=0 ▽=0	GENERAL TOLERANCES (UNLESS SPECIFIED)		DIMENSION STYLE IN/MM		SCALE 1:1	DESIGN UNITS INCH	THIRD ANGLE PROJECTION	
		4 PLACES ± --- ± --- 3 PLACES ± --- ± --- 2 PLACES ± --- ± --- 1 PLACE ± --- ± ---	mm INCH ± --- ± --- ± --- ± --- ± --- ± --- ± --- ± ---	DRAWN BY RSTONE	DATE 2012/05/18	TITLE CONTROL DOC FOR ULTRA-LOCK ZONE 2		MOLEX INCORPORATED	
DRAFT WHERE APPLICABLE MUST REMAIN WITHIN DIMENSIONS		CHECKED BY K JOZWIK	DATE 2012/05/22	APPROVED BY JFMURPHY		DATE 2012/08/27	MATERIAL NO. 1206149999		
THIS DRAWING CONTAINS INFORMATION THAT IS PROPRIETARY TO MOLEX INCORPORATED AND SHOULD NOT BE USED WITHOUT WRITTEN PERMISSION									

M12/MICROCHANGE ULTRA-LOCK CORD CONNECTORS AND CORD SETS

LWO 3 000 C02 M 020 8  
 I II III IV V VI VII

I: CONNECTOR TYPE  
 LWO= ULTRA-LOCK ZONE 2 MALE OR FEMALE SINGLE END CORDSET  
 LWW= ULTRA-LOCK ZONE 2 FEMALE TO STANDARD ULTRA-LOCK MALE DOUBLE ENDED CORDSET  
 WLW= ULTRA-LOCK ZONE 2 MALE TO STANDARD ULTRA-LOCK FEMALE DOUBLE ENDED CORDSET  
 LW8= ULTRA-LOCK ZONE 2 FEMALE TO STANDARD M12 MALE DOUBLE ENDED CORDSET  
 8LW= ULTRA-LOCK ZONE 2 MALE TO STANDARD M12 FEMALE DOUBLE ENDED CORDSET  
 LWLW= ULTRA-LOCK ZONE 2 FEMALE TO ULTRA-LOCK ZONE 2 MALE DOUBLE ENDED CORDSET

II: NUMBER OF POLES: 3= 3 PIN, 4= 4 PIN, 5 = 5 PIN

III: CONFIGURATION  
 SINGLE ENDED:  
 000= STRAIGHT FEMALE CONNECTOR  
 001= FEMALE 90°  
 006= STRAIGHT MALE, EXTERNAL THREAD  
 007= MALE 90°

DOUBLE ENDED:  
 030= STRAIGHT FEMALE CONNECTOR TO STRAIGHT MALE CONNECTOR  
 031= FEMALE 90° TO MALE STRAIGHT  
 032= FEMALE STRAIGHT TO MALE 90°  
 033= FEMALE 90° TO MALE 90°

IV: CABLE TYPE  
 C02= SJ00W YELLOW, 18 AWG, DC CODE (CSA ONLY) **G**  
 K03= PLTC/ITC, 18 AWG, TPE JACKET  
 K05= PLTC/ITC, 22 AWG, TPE JACKET

V: UNIT OF MEASURE  
 F= FEET  
 M= METERS

VI: CABLE LENGTH (MAY BE ANY 3 DIGIT NUMBER FROM 001-100)  
 1ST DIGIT= 10 X LENGTH  
 2ND DIGIT= 1 X LENGTH  
 3RD DIGIT= .1 X LENGTH

VII: COUPLING NUT MATERIAL  
 ULTRA-LOCK ZONE 2 END(S) ARE STAINLESS STEEL

M12 OR ULTRA-LOCK:  
 NONE = STANDARD MATERIAL (NICKEL PLATED BRASS)  
 8= STAINLESS STEEL

**NOTICE: THIS PART IS CSA AND FACTORY MUTUAL APPROVED  
 NO CHANGES CAN BE MADE TO THE ASSEMBLY, COMPONENTS  
 OR SUPPLIER WITHOUT PRIOR APPROVAL FROM CSA AND  
 FACTORY MUTUAL.**

M12/MICROCHANGE ULTRA-LOCK OUTLETS

LWR 3 A00 A18 M 020 8  
 I II III IV V VI VII

I: CONNECTOR TYPE  
 LWR= LOCKING INLETS AND OUTLETS

II: NUMBER OF POLES 3=3 PIN, 4= 4 PIN, & 5= 5 PIN

III: CONFIGURATION  
 SINGLE ENDED:  
 A00= FEMALE STRAIGHT (INT.THEAD) 1/4-18 NPT  
 A06= MALE STRAIGHT (EXT.THEAD) 1/4-18 NPT  
 000= FEMALE STRAIGHT (INT.THEAD) 1/2-14 NPT  
 006= MALE STRAIGHT (EXT.THEAD) 1/2-14 NPT

**G** IV: WIRE TYPE  
 A18= 22 AWG, PVC, DC COLOR CODE, UL TYPE 1061  
 A16= 18 AWG, PVC, DC COLOR CODE, UL TYPE 1569

V: UNIT OF MEASURE  
 A= INCHES  
 F= FEET  
 C= CENTIMETERS  
 M= METERS

VI: WIRE LENGTH (MAY BE ANY 3 DIGIT NUMBER FROM 001-100)  
 1ST DIGIT= 10 X LENGTH  
 2ND DIGIT= 1 X LENGTH  
 3RD DIGIT= .1 X LENGTH

VII: SHELL MATERIAL  
 M12 OR ULTRA-LOCK:  
 NONE = STANDARD MATERIAL (COPPER ZINC ALLOY)  
 3= NICKEL PLATED BRASS  
 8= STAINLESS STEEL

CORSET NOTE IV, ADD CSA OUTLET NOTE IV, REMOVE PCB PINS EC NO: IPGZ018-0141 DR: MHRSTONE 2017/08/28 CHKD: BWOODMAN 2017/08/30 APPR: BWOODMAN 2017/09/06	DESCRIPTION G	QUALITY SYMBOLS	GENERAL TOLERANCES (UNLESS SPECIFIED)	DIMENSION STYLE IN/MM	SCALE 1:1	DESIGN UNITS INCH	THIRD ANGLE PROJECTION	
		▽=0	mm INCH	DRAWN BY DATE	CONTROL DOC FOR ULTRA-LOCK ZONE 2			
		▽=0	4 PLACES ± --- ± ---	RSTONE 2012/05/18				
				3 PLACES ± --- ± ---	CHECKED BY DATE	MOLEX INCORPORATED		
		2 PLACES ± --- ± ---	K JOZWIK 2012/05/22					
		1 PLACE ± --- ± ---	APPROVED BY DATE	SD-120614-999				
		ANGULAR ± ---°	JFMURPHY 2012/08/27					
			MATERIAL NO.	DOCUMENT NO.				
			1206149999	SHEET NO. 3 OF 3				
			SIZE B	THIS DRAWING CONTAINS INFORMATION THAT IS PROPRIETARY TO MOLEX INCORPORATED AND SHOULD NOT BE USED WITHOUT WRITTEN PERMISSION				

CLASS 1, DIVISION 2, GROUP A, B, C, OR D  
HAZARDOUS LOCATION

NON-HAZARDOUS LOCATION

CLASS 1, DIVISION 2, GROUP A, B, C, OR D  
HAZARDOUS LOCATION

NON-HAZARDOUS LOCATION

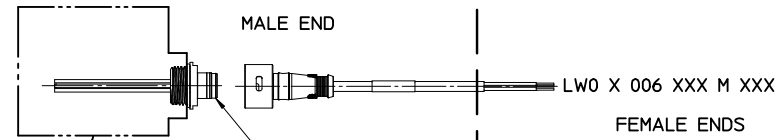
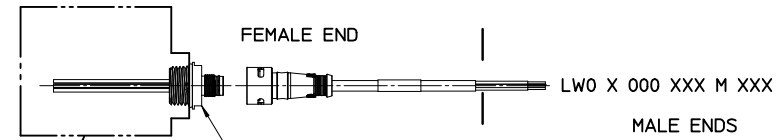

LWR X 006 A18 CXXX  
(MALE 1/2" NPT)  
LWR X A06 A18 CXXX  
(MALE 1/4" NPT)

LWR X 000 A18 CXXX  
(FEMALE 1/2" NPT)  
LWR X A00 A18 CXXX  
(FEMALE 1/4" NPT)

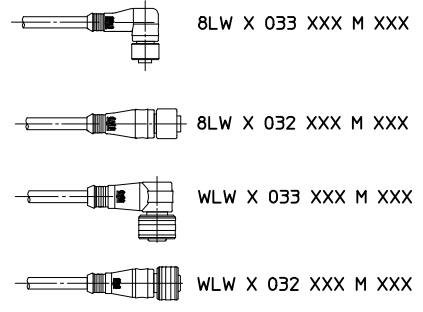
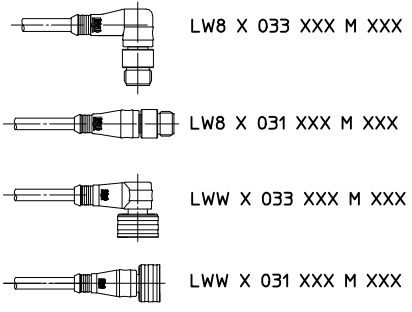
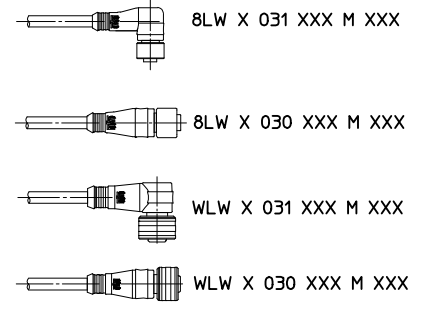
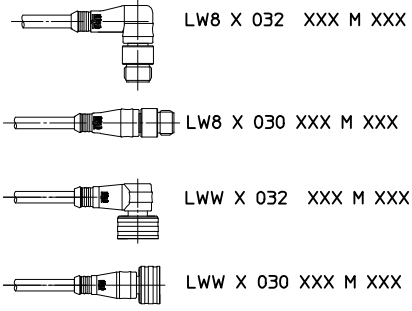
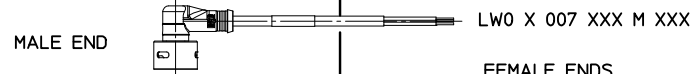
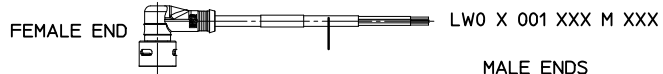

- NOTES:
1. THE INSTALLATION MUST BE IN ACCORDANCE WITH THE NATIONAL ELECTRICAL CODE (NEC), ANSI/NFPA 70. SPECIFIC REQUIREMENTS FOR THE INSTALLATION OF ITC RATED CABLE MAY BE FOUND IN ARTICLE 501.4(B)(1)(5) AND ARTICLE 727.4
  2. THE MOLDED CONSTRUCTION OF THE CORDSET AND GAS/VAPORTIGHT CONTINUOUS SHEATH OF THE CABLE MEET THE REQUIREMENTS OF THE NEC, ARTICLE 501-5(E)(2) FOR CABLE SEALS IN CLASS 1, DIVISION 2

FIELD DEVICE APPROVAL FOR CLASS 1, DIV. 2 OR CLASS 1, ZONE2 INSTALLATIONS

NOTICE: THIS PART IS CSA AND FACTORY MUTUAL APPROVED  
NO CHANGES CAN BE MADE TO THE ASSEMBLY, COMPONENTS OR SUPPLIER WITHOUT PRIOR APPROVAL FROM CSA AND FACTORY MUTUAL.

THIS DRAWING SUPERSEDES ES-120614-001 REV-B

SEE SHEET 3 EC NO: IPG2018-0141 DRAWN BY: DRWINRSTONE 2017/08/28 CHKD: BWOODMAN 2017/08/30 APPR: BWOODMAN 2017/09/06	QUALITY SYMBOLS  	GENERAL TOLERANCES (UNLESS SPECIFIED)		DIMENSION STYLE		SCALE	DESIGN UNITS	THIRD ANGLE PROJECTION			
				IN/MM		1:1	INCH				
		4 PLACES ± --- ± ---	3 PLACES ± --- ± ---	2 PLACES ± --- ± ---	1 PLACE ± --- ± ---	DRAWN BY: RSTONE	DATE: 2012/05/18	TITLE: CONTROL DOC FOR ULTRA-LOCK ZONE 2			
		ANGULAR ± --- °				CHECKED BY: K JOZWIK	DATE: 2012/05/22	APPROVED BY: JFMURPHY			
DRAFT WHERE APPLICABLE MUST REMAIN WITHIN DIMENSIONS		MATERIAL NO. 1206149999		DOCUMENT NO. SD-120614-999		SHEET NO. 1 OF 3		THIS DRAWING CONTAINS INFORMATION THAT IS PROPRIETARY TO MOLEX INCORPORATED AND SHOULD NOT BE USED WITHOUT WRITTEN PERMISSION			

REF. SEE SHEET 3 FOR CONFIGURATION INFORMATION

CLASS 1, DIVISION 2, GROUP A, B, C, OR D  
HAZARDOUS LOCATION

HAZARDOUS LOCATION

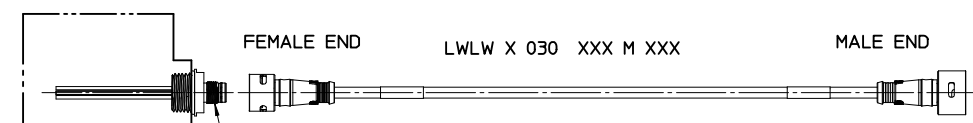

LWR X 006 A18 CXXX  
(MALE 1/2" NPT)  
LWR X A06 A18 CXXX  
(MALE 1/4" NPT)

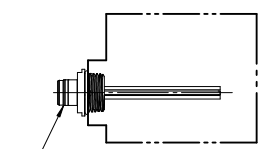

LWR X 000 A18 CXXX  
(FEMALE 1/2" NPT)  
LWR X A00 A18 CXXX  
(FEMALE 1/4" NPT)

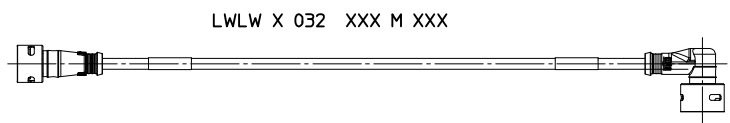

LWLW X 031 XXX M XXX

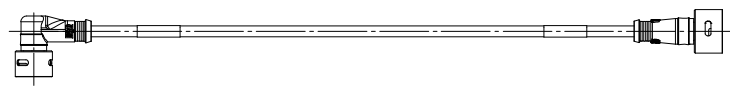

LWLW X 033 XXX M XXX

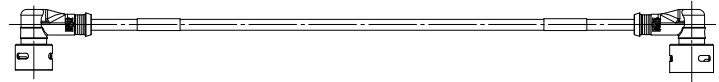

- REF:
1. SEE SHEET 1 FOR NOTES
  2. SEE SHEET 3 FOR CONFIGURATION INFORMATION

NOTICE: THIS PART IS CSA AND FACTORY MUTUAL APPROVED  
NO CHANGES CAN BE MADE TO THE ASSEMBLY, COMPONENTS  
OR SUPPLIER WITHOUT PRIOR APPROVAL FROM CSA AND  
FACTORY MUTUAL.

SEE SHEET 3 EC NO: JFG2018-0141 2017/08/28 DRAWNR:STONE 2017/08/30 CHKD:WOODMAN 2017/09/06 APPR:WOODMAN	QUALITY SYMBOLS ▽=0 ▽=0	GENERAL TOLERANCES (UNLESS SPECIFIED)		DIMENSION STYLE IN/MM		SCALE 1:1	DESIGN UNITS INCH	THIRD ANGLE PROJECTION	
		4 PLACES ± --- ± --- 3 PLACES ± --- ± --- 2 PLACES ± --- ± --- 1 PLACE ± --- ± ---	mm INCH ± --- ± --- ± --- ± --- ± --- ± --- ± --- ± ---	DRAWN BY RSTONE	DATE 2012/05/18	TITLE CONTROL DOC FOR ULTRA-LOCK ZONE 2			
REV	DESCRIPTION	MATERIAL NO. 1206149999		APPROVED BY JFMURPHY	DATE 2012/08/27	MOLEX INCORPORATED		SHEET NO. 2 OF 3	DOCUMENT NO. SD-120614-999
DRAFT WHERE APPLICABLE MUST REMAIN WITHIN DIMENSIONS		THIS DRAWING CONTAINS INFORMATION THAT IS PROPRIETARY TO MOLEX INCORPORATED AND SHOULD NOT BE USED WITHOUT WRITTEN PERMISSION							

M12/MICROCHANGE ULTRA-LOCK CORD CONNECTORS AND CORD SETS

LWO 3 000 C02 M 020 8  
 I II III IV V VI VII

I: CONNECTOR TYPE  
 LWO= ULTRA-LOCK ZONE 2 MALE OR FEMALE SINGLE END CORDSET  
 LWW= ULTRA-LOCK ZONE 2 FEMALE TO STANDARD ULTRA-LOCK MALE DOUBLE ENDED CORDSET  
 WLW= ULTRA-LOCK ZONE 2 MALE TO STANDARD ULTRA-LOCK FEMALE DOUBLE ENDED CORDSET  
 LW8= ULTRA-LOCK ZONE 2 FEMALE TO STANDARD M12 MALE DOUBLE ENDED CORDSET  
 8LW= ULTRA-LOCK ZONE 2 MALE TO STANDARD M12 FEMALE DOUBLE ENDED CORDSET  
 LWLW= ULTRA-LOCK ZONE 2 FEMALE TO ULTRA-LOCK ZONE 2 MALE DOUBLE ENDED CORDSET

II: NUMBER OF POLES: 3= 3 PIN, 4= 4 PIN, 5 = 5 PIN

III: CONFIGURATION  
 SINGLE ENDED:  
 000= STRAIGHT FEMALE CONNECTOR  
 001= FEMALE 90°  
 006= STRAIGHT MALE, EXTERNAL THREAD  
 007= MALE 90°

DOUBLE ENDED:  
 030= STRAIGHT FEMALE CONNECTOR TO STRAIGHT MALE CONNECTOR  
 031= FEMALE 90° TO MALE STRAIGHT  
 032= FEMALE STRAIGHT TO MALE 90°  
 033= FEMALE 90° TO MALE 90°

IV: CABLE TYPE  
 C02= SJ00W YELLOW, 18 AWG, DC CODE (CSA ONLY) **G**  
 K03= PLTC/ITC, 18 AWG, TPE JACKET  
 K05= PLTC/ITC, 22 AWG, TPE JACKET

V: UNIT OF MEASURE  
 F= FEET  
 M= METERS

VI: CABLE LENGTH (MAY BE ANY 3 DIGIT NUMBER FROM 001-100)  
 1ST DIGIT= 10 X LENGTH  
 2ND DIGIT= 1 X LENGTH  
 3RD DIGIT= .1 X LENGTH

VII: COUPLING NUT MATERIAL  
 ULTRA-LOCK ZONE 2 END(S) ARE STAINLESS STEEL

M12 OR ULTRA-LOCK:  
 NONE = STANDARD MATERIAL (NICKEL PLATED BRASS)  
 8= STAINLESS STEEL

**NOTICE: THIS PART IS CSA AND FACTORY MUTUAL APPROVED  
 NO CHANGES CAN BE MADE TO THE ASSEMBLY, COMPONENTS  
 OR SUPPLIER WITHOUT PRIOR APPROVAL FROM CSA AND  
 FACTORY MUTUAL.**

M12/MICROCHANGE ULTRA-LOCK OUTLETS

LWR 3 A00 A18 M 020 8  
 I II III IV V VI VII

I: CONNECTOR TYPE  
 LWR= LOCKING INLETS AND OUTLETS

II: NUMBER OF POLES 3=3 PIN, 4= 4 PIN, & 5= 5 PIN

III: CONFIGURATION  
 SINGLE ENDED:  
 A00= FEMALE STRAIGHT (INT.THEAD) 1/4-18 NPT  
 A06= MALE STRAIGHT (EXT.THEAD) 1/4-18 NPT  
 000= FEMALE STRAIGHT (INT.THEAD) 1/2-14 NPT  
 006= MALE STRAIGHT (EXT.THEAD) 1/2-14 NPT

**G** IV: WIRE TYPE  
 A18= 22 AWG, PVC, DC COLOR CODE, UL TYPE 1061  
 A16= 18 AWG, PVC, DC COLOR CODE, UL TYPE 1569

V: UNIT OF MEASURE  
 A= INCHES  
 F= FEET  
 C= CENTIMETERS  
 M= METERS

VI: WIRE LENGTH (MAY BE ANY 3 DIGIT NUMBER FROM 001-100)  
 1ST DIGIT= 10 X LENGTH  
 2ND DIGIT= 1 X LENGTH  
 3RD DIGIT= .1 X LENGTH

VII: SHELL MATERIAL  
 M12 OR ULTRA-LOCK:  
 NONE = STANDARD MATERIAL (COPPER ZINC ALLOY)  
 3= NICKEL PLATED BRASS  
 8= STAINLESS STEEL

CORSET NOTE IV, ADD CSA OUTLET NOTE IV, REMOVE PCB PINS EC NO: IPGZ018-0141 DR: MHRSTONE 2017/08/28 CHKD: BWOODMAN 2017/08/30 APPR: BWOODMAN 2017/09/06	DESCRIPTION G	QUALITY SYMBOLS	GENERAL TOLERANCES (UNLESS SPECIFIED)	DIMENSION STYLE IN/MM	SCALE 1:1	DESIGN UNITS INCH	THIRD ANGLE PROJECTION	
		▽=0	mm INCH	DRAWN BY DATE	CONTROL DOC FOR ULTRA-LOCK ZONE 2			
		▽=0	4 PLACES ± --- ± ---	RSTONE 2012/05/18				
				3 PLACES ± --- ± ---	CHECKED BY DATE	MOLEX INCORPORATED		
		2 PLACES ± --- ± ---	K JOZWIK 2012/05/22					
		1 PLACE ± --- ± ---	APPROVED BY DATE	DOCUMENT NO. SD-120614-999 SHEET NO. 3 OF 3				
		ANGULAR ± ---°	JFMURPHY 2012/08/27					
			MATERIAL NO. 1206149999	THIS DRAWING CONTAINS INFORMATION THAT IS PROPRIETARY TO MOLEX INCORPORATED AND SHOULD NOT BE USED WITHOUT WRITTEN PERMISSION				
			SIZE B					