

MAXM17537 15V Output Evaluation Kit

Evaluates: MAXM17537 15V Output

General Description

The *Himalaya* series of voltage regulator ICs and power modules enable cooler, smaller, and simpler power-supply solutions. The MAXM17537EVKIT# 15V-output evaluation kit (EV kit) is a demonstration circuit of the MAXM17537 60V, 3A high-efficiency, current-mode, synchronous step-down DC-DC switching power module. The EV kit operates over a wide input-voltage of 19V to 60V and provides up to 3A load current with a 15V-output voltage. The EV kit is programmed to switch at a frequency of 700kHz. The module is simple to use and easily configurable with minimal external components. It features cycle-by-cycle peak current-limit protection, undervoltage lockout (EN/UVLO), and thermal shutdown.

The EV kit includes the compact, 29-pin, 15mm x 9mm x 4.32mm SiP package MAXM17537 module installed and is rated to operate over the full industrial -40°C to 125°C temperature range.

The MAXM17537 module data sheet provides a complete description of the part that should be read in conjunction with this data sheet prior to operating the EV kit. For full module features, benefits and parameters, refer to the MAXM17537 data sheet.

Benefits and Features

- Wide 19V to 60V Input Range
- Highly Integrated Solution with Built-In Shielded Inductor
- Programmed 15V Output, Up to 3A Output Current
- 700kHz Switching Frequency
- MAXM17537 Offers High 95.6% Efficiency ($V_{IN} = 24V$, $V_{OUT} = 15V$, $I_{OUT} = 2A$)
- All Ceramic Capacitors and Ultra-Compact Solution
- Selectable PWM, DCM, and PFM Modes
- Programmable 4ms Soft-Start Time and Prebias Startup
- Open-Drain \overline{RESET} Output Pulled Up to 5V V_{CC}
- Programmable EN/UVLO Threshold
- Provision for External Frequency Synchronization
- Hiccup Over Current Protection (OCP)
- Overtemperature Protection (OTP)
- -40°C to +125°C Industrial Temperature Range
- Complies with CISPR22(EN55022) Class B Conducted and Radiated Emissions

[Ordering Information](#) appears at end of data sheet.

MAXM17537 15V Output Evaluation Kit

Evaluates: MAXM17537 15V Output

Quick Start

Recommended Equipment

- MAXM17537EVKIT# evaluation kit
- 19V to 60V DC, 3A power supply
- Dummy load capable of sinking 3A
- Digital voltmeter (DVM)
- 100MHz dual-trace oscilloscope

Equipment Setup and Procedure

The MAXM17537EVKIT# is fully assembled and tested. Follow the steps below to verify board operation.

Caution: Do not turn on the power supply until all connections are completed.

- 1) Set the power supply at a voltage between 19V and 60V. Disable the power supply.
- 2) Connect the positive and negative terminals of the power supply to VIN and PGND PCB pads, respectively.
- 3) Connect the positive and negative terminals of the 3A load to OUT and PGND PCB pads, respectively, and then set the load to 0A.
- 4) Connect the DVM across the OUT PCB pad and the PGND PCB pad.
- 5) Verify that shunts are not installed on jumper J1. See [Table 1](#) for details.
- 6) Select the shunt position on jumper J2 according to the intended mode of operation. See [Table 2](#) for details.
- 7) Enable the input power supply.
- 8) Verify the DVM display 15V.
- 9) Increase the load up to 3A to verify the output voltage is 15V using DVM.

Detailed Description

The MAXM17537EVKIT# is a proven circuit to demonstrate the high-voltage, high-efficiency, and compact-size solution of the MAXM17537 synchronous step-down DC-DC power module. The output voltage is preset to 15V to operate from 19V to 60V input and provides up to 3A load current. The optimal frequency is set at 700kHz to maximize efficiency and minimize component size. The EV kit includes five test points: TP1 for monitoring the V_{CC}, TP2 for monitoring the $\overline{\text{RESET}}$, TP3 for measuring the LX voltage, TP4 for monitoring the DL voltage, and TP5 for measuring the BST voltage.

Soft-Start Input (SS)

The MAXM17537 module implements adjustable soft-start operation to reduce inrush current. A capacitor connected from the SS pin to SGND programs the soft-start time. The selected output capacitance (C_{SEL}) and the output voltage (V_{OUT}) determine the minimum required soft-start capacitor as follows:

$$C_{SS} \geq 28 \times 10^{-6} \times C_{SEL} \times V_{OUT}$$

The soft-start time (t_{SS}) is related to the capacitor connected at SS (C_{SS}) by the following equation:

$$t_{SS} = C_{SS}/5.55$$

where t_{SS} is in ms and C_{SS} is in nF. For example, to program a 4ms soft-start time, a 22nF capacitor should be connected from the SS pin to SGND.

Regulator Enable/Undervoltage-Lockout Level (EN/UVLO)

The EV kit offers an adjustable input undervoltage-lockout level by resistor-dividers connecting between the IN, EN/UVLO, and SGND pins. For normal operation, a shunt should not be installed across pins 1-2 on J1 to enable the output through an internal pullup 3.32M Ω resistor from the EN/UVLO pin to the IN pin. To disable the output, install the shunt across pins 1-2 on J1 to pull the EN/UVLO pin to SGND. See [Table 1](#) for J1 setting details. The EV kit also provides an R3 resistor to program a UVLO threshold voltage at which an input-voltage level device turns on. The R3 resistor can be calculated by the following equation:

$$R3 = 3320 \times 1.215 / (V_{INU} - 1.215)$$

where V_{INU} is the input voltage at which the device is required to turn on, and R3 is in k Ω .

Table 1. EN/UVLO Enable/Disable Configuration (J1)

SHUNT POSITION	EN/UVLO PIN	MAXM17537 OUTPUT
1-2	Connected to SGND	Disabled
Not installed*	Connect to the center node of resistor-divider 3.32M Ω and R3	Enabled, UVLO level set through the 3.32M Ω and R3 resistors

*Default position.

MAXM17537 15V Output Evaluation Kit

Evaluates: MAXM17537 15V Output

MODE/SYNC Selection (MODE/SYNC)

The module's MODE pin can be used to select among the PWM, PFM, or DCM modes of operation. The logic state of the MODE/SYNC pin is latched when the V_{CC} and EN/UVLO voltages exceed the respective UVLO rising thresholds and all internal voltages are ready to allow LX switching. State changes on the MODE/SYNC pin are ignored during normal operation. Refer to the MAXM17537 module data sheet for more information on the PWM, PFM and DCM modes of operation.

Table 2 lists the J2 jumper settings that can be used to configure the desired mode of operation. The internal oscillator of the module can be synchronized to an external clock signal on the MODE/SYNC pin. The external synchronization clock frequency must be between $1.1 \times f_{SW}$ and $1.4 \times f_{SW}$, where f_{SW} is the frequency of operation set by R4. The minimum external clock high pulse width should be greater than 50ns.

EXTVCC Linear Regulator

Powering V_{CC} of the module from EXTVCC increases the efficiency of the power converter at higher input voltages. If the applied EXTVCC voltage is greater than 4.7V (typ), V_{CC} is powered from EXTVCC. If EXTVCC is lower than 4.7V (typ), V_{CC} is powered from V_{IN} . Refer to the MAXM17537 module data sheet for further information. To connect EXTVCC to V_{OUT} place the shunt across pins 2-3 of jumper J3. See Table 3 for summary of EXTVCC jumper configurations.

Electro-Magnetic Interference (EMI)

Table 2. MODE/SYNC Description (J2)

SHUNT POSITION	MODE/SYNC PIN	MAXM17537 MODE
Not installed	Unconnected	PFM mode of operation
1-2	Connected to V_{CC}	DCM mode of operation
2-3*	Connected to SGND	PWM mode of operation

*Default position.

Compliance to conducted emissions (CE) standards requires an EMI filter at the input of a switching power converter. The EMI filter attenuates high-frequency currents drawn by the switching power converter, and limits the noise injected back into the input power source.

Use of EMI filter components as shown in the EV kit schematic results in lower conducted emissions below CISPR22 Class B limits. The MAXM17537EVKIT# PCB layout is also designed to limit radiated emissions from switching nodes of the power converter resulting in radiated emissions below CISPR22 Class B limits. Further, capacitors 150pF/100V and 0.1 μ F/100V placed near the input of the board helps in attenuating high-frequency noise.

Hot-Plug-In and Long Input Cables

The MAXM17537EVKIT# PCB provides an electrolytic capacitor (C24, 47 μ F/80V) to dampen input voltage peaks and oscillations that can arise during hot-plug-in and/or due to long input cables. This capacitor limits the peak voltage at the input of the MAXM17537 power module, when the EV kit is powered directly from a precharged capacitive source or an industrial backplane PCB. Long input cables, between input power source and the EV kit circuit can cause input-voltage oscillations due to the inductance of the cables. The equivalent series resistance (ESR) of the electrolytic capacitor helps damp out the oscillations caused by long input cables.

Table 3. EXTVCC Configuration (J3)

SHUNT POSITION	EXTVCC PIN	MAXM17537 EXTVCC
Not installed	Unconnected	V_{CC} powered by V_{IN}
1-2	Connected to SGND	V_{CC} powered by V_{IN}
2-3*	Connected to V_{OUT}	V_{CC} powered by V_{OUT}

*Default position.

MAXM17537EVKIT# Performance Report

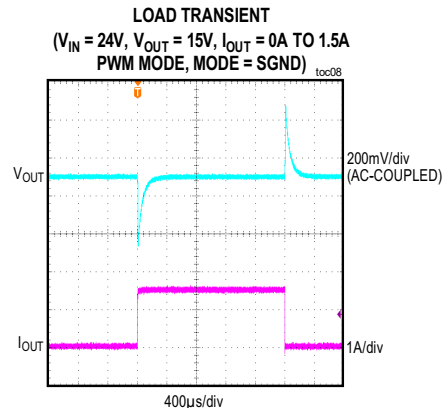
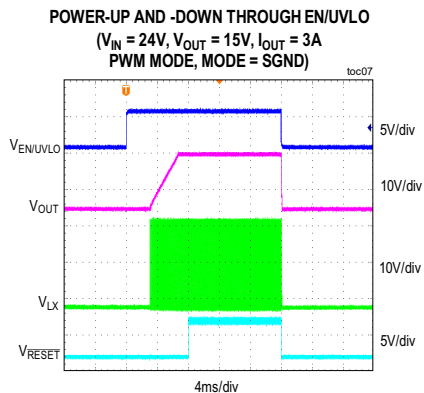
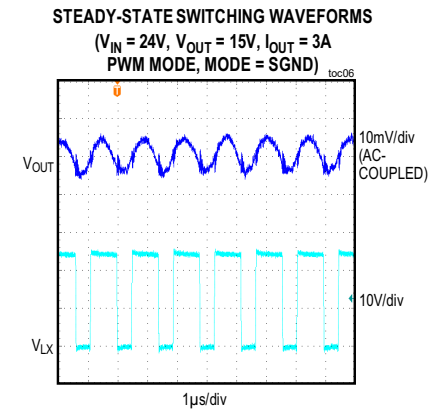
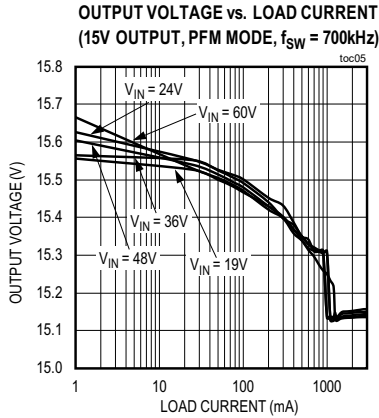
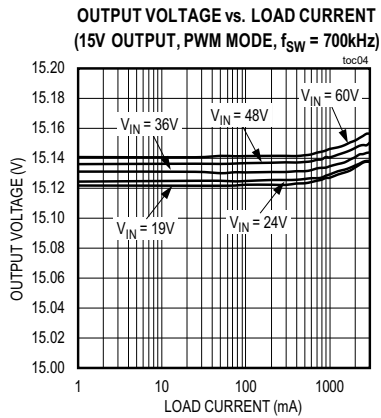
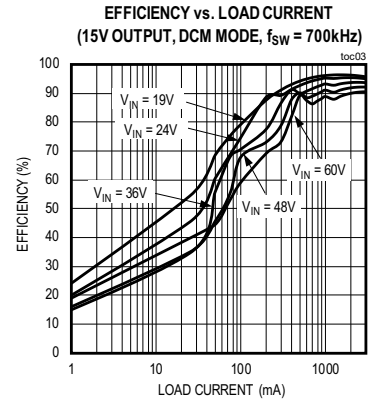
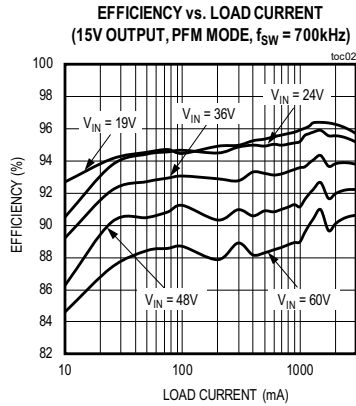
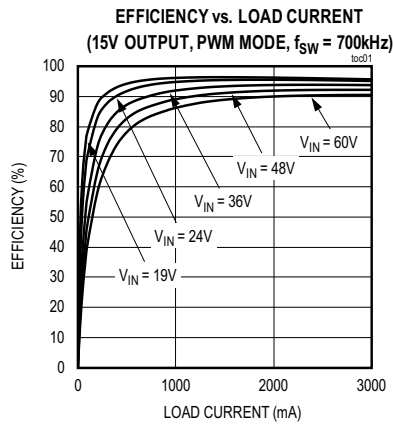

MAXM17537EVKIT# Performance Report (continued)

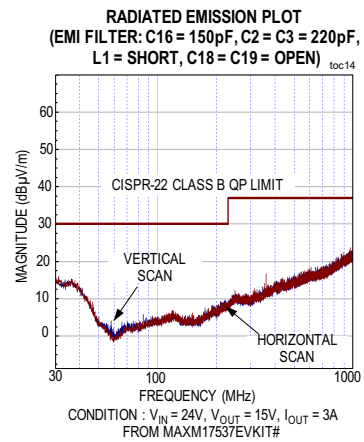
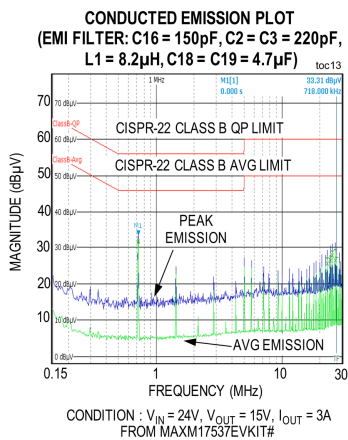
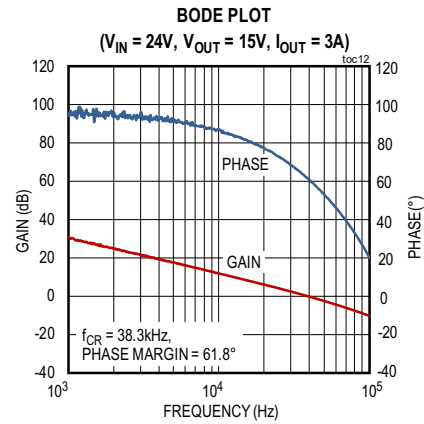
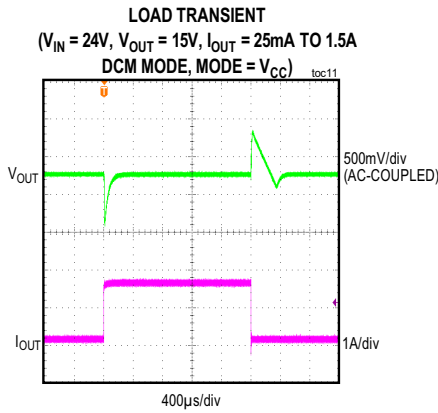
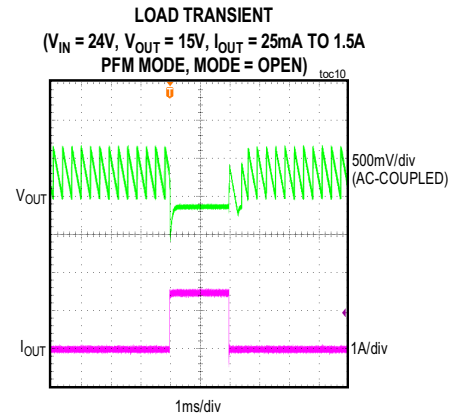
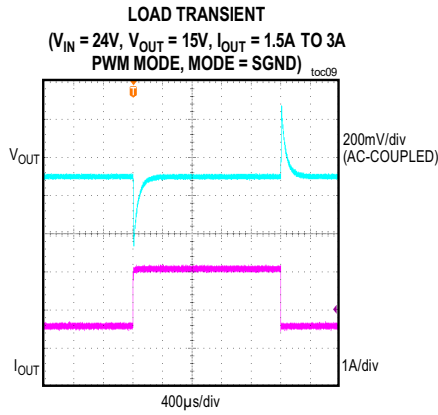

MAXM17537 15V Output Evaluation Kit

Evaluates: MAXM17537 15V Output

Component Suppliers

SUPPLIER	WEBSITE
TDK Corp.	www.tdk.com
Murata Americas	www.murata.com
Panasonic Corp.	www.panasonic.com
Vishay	www.vishay.com
Coilcraft	www.coilcraft.com

Note: Indicate that you are using the MAXM17537 when contacting these component suppliers.

Ordering Information

PART	TYPE
MAXM17537EVKIT#	EV Kit

#Denotes RoHS compliance.

MAXM17537EVKIT# Bill of Materials

ITEM	QTY	REF DES	VAR STATUS	MAXINV	MFG PART #	MANUFACTURER	VALUE	DESCRIPTION
1	4	BST, DL, LX, TP1	Pref	02-TPMINI5000-00	5000	KEystone	N/A	TEST POINT; PIN DIA = 0.1IN; TOTAL LENGTH = 0.3IN; BOARD HOLE = 0.04IN; RED; PHOSPHOR BRONZE WIRE SILVER PLATE FINISH; RECOMMENDED FOR BOARD THICKNESS = 0.062IN; NOT FOR COLD TEST
2	2	C2, C3	Pref	EC11100001494	C1608C0G2A221J080AA	TDK	220PF	CAP; SMT (0603); 220PF; 5%; 100V; COG; CERAMIC CHIP
3	4	C4, C7, C18, C19	Pref	20-004U7-08C	GRM31CZ72A475KE11	MURATA	4.7µF	CAP; SMT (1206); 4.7UF; 10%; 100V; X7R; CERAMIC CHIP ; NOTE: PURCHASE DIRECT FROM THE MANUFACTURER
4	4	C8, C9, C15, C17	Pref	20-000U1-01	C0603KRX7R0BB104; GRM188R72A104KA35; GCJ188R72A104KA01; HMK107B7104KA; 06031C104KAT2A	YAGEO; MURATA; MURATA; TAIYO YUDEN; AVX	0.1µF	CAPACITOR; SMT (0603); CERAMIC CHIP; 0.1µF; 100V; TOL = 10%; TG = -55°C TO +125°C; TC = X7R
5	1	C10	Pref	20-002P2-N6	06035J2R2BBT; GRM39C0G2R2B50V	AVX; MURATA	2.2PF	CAPACITOR; SMT (0603); CERAMIC CHIP; 2.2PF; 50V; TOL = ±0.1PF; MODEL = ACCU-P; TG = -55°C TO +125°C
6	1	C11	Pref	20-0U022-91	C0603C223K5RAC; GRM188R71H223K; C1608X7R1H223K080AA; GCJ188R71H223KA01	KEMET; MURATA; TDK; MURATA	0.022µF	CAPACITOR; SMT (0603); CERAMIC CHIP; 0.022UF; 50V; TOL = 10%; TG = -55°C TO +125°C; TC = X7R
7	2	C13, C14	Pref	20-0010U-B40	GRM32ER71H106KA12; CL32B106KBJNNN; UMJ325KB7106KMH; 12105C106K4Z2A	MURATA; SAMSUNG ELECTRONICS; TAIYO YU	10µF	CAPACITOR; SMT (1210); CERAMIC CHIP; 10µF; 50V; TOL = 10%; TG = -55°C TO +125 DEG; TC = X7R
8	1	C16	Pref	EC111000001357	C1005C0G2A151J050BA	TDK	150PF	CAP; SMT (0402); 150PF; 5%; 100V; COG; CERAMIC CHIP
9	1	C24	Pref	20-0047U-A17	EEE-FK1K470P	PANASONIC	47UF	CAPACITOR; SMT (CASE_G); ALUMINUM-ELECTROLYTIC; 47µF; 80V; TOL = 20%
10	1	J1	Pref	01-PBC02SABN2P-21	PBC02SABN	SULLINS	PBC02SABN	CONNECTOR; MALE; THROUGH HOLE; BREAKAWAY; STRAIGHT; 2PINS
11	2	J2, J3	Pref	01-PBC03SABN3P-21	PBC03SABN	SULLINS	PBC03SABN	CONNECTOR; MALE; THROUGH HOLE; BREAKAWAY; STRAIGHT; 3PINS
12	4	J4, J6, J7, TP5	Pref	02-57541P-01	575-4	KEystone	575-4	RECEPTACLE; JACK; BANANA; 0.203IN [5.2MM] DIA X 0.218IN [5.5MM] L; 0.203D/0.218L; NICKEL PLATED BRASS
13	4	MH1-MH4	Pref	02-MS440038P-02	91772A108; PHILLIPS-PAN_4-40X3/8IN; PMSS4400038PH; 9901	GENERIC PART	N/A	MACHINE SCREW; PHILLIPS; PAN; 4-40; 3/8IN; 18-8 STAINLESS STEEL
14	4	MH1-MH4	Pref	02-SO440012H-01	MCH_SO_F_HEX_4-40X1/2	GENERIC PART	N/A	STANDOFF; FEMALE-THREADED; HEX; 4-40; 1/2IN; ALUMINUM
15	4	OUT, PGND, PGND1, VIN	Pref	01-9020BUS20AWG-00	9020 BUSS	WEICO WIRE	MAXIMPAD	EVK KIT PARTS; MAXIM PAD; WIRE; NATURAL; SOLID; WEICO WIRE; SOFT DRAWN BUS TYPE-S; 20AWG

MAXM17537 15V Output
Evaluation Kit

Evaluates: MAXM17537 15V Output

MAXM17537EVKIT# Bill of Materials (continued)

ITEM	QTY	REF DES	VAR STATUS	MAXINV	MFG PART #	MANUFACTURER	VALUE	DESCRIPTION
16	1	R1	Pref	80-0806K-19	ERJ-3EKF8063	PANASONIC	806K	RES; SMT (0603); 806K; 1%; ±100PPM°C; 0.1W
17	1	R2	Pref	80-051K1-24	CRCW060351K1FK; ERJ-3EKF5112	VISHAY DALE; PANASONIC	51.1K	RESISTOR; 0603; 51.1K; 1%; 100PPM; 0.10W; THICK FILM
18	1	R3	Pref	80-0232K-24	CRCW0603232KFK	VISHAY DALE	232K	RESISTOR; 0603; 232KΩ; 1%; 100PPM; 0.1W; THICK FILM
19	1	R4	Pref	80-025K5-24	CRCW060325K5FK	VISHAY DALE	25.5K	RESISTOR; 0603; 25.5KΩ; 1%; 100PPM; 0.10W; THICK FILM
20	1	R5	Pref	80-0010K-24	CRCW060310K0FK; ERJ-3EKF1002	VISHAY DALE; PANASONIC	10K	RESISTOR; 0603; 10K; 1%; 100PPM; 0.10W; THICK FILM
21	1	R6	Pref	80-0000R-27	CRCW06030000ZS; MCR03EZPJ000; ERJ-3GEY0R00	VISHAY DALE; ROHM; PANASONIC	0	RESISTOR; 0603; 0Ω; 0%; JUMPER; 0.10W; THICK FILM
22	3	SU1-SU3	Pref	02-JMPFS1100B-00	S1100-B;SX1100-B; STC02SYAN	KYCON; KYCON; SULLINS ELECTRONICS CORP.	SX1100-B	TEST POINT; JUMPER; STR; TOTAL LENGTH = 0.24IN; BLACK; INSULATION = PBT; PHOSPHOR BRONZE CONTACT = GOLD PLATED
23	1	U1	Pref	00-SAMPLE-01	MAXM17537	MAXIM	MAXM17537	EVKIT PART - IC; MAXM17537; LGA29-3EP; PACKAGE OUTLINE NUMBER: 21-100177; PACKAGE LAND PATTERN: 90-100055
24	1	VCC	Pref	02-TPCOMP5005-00	5005	KEYSTONE	N/A	TEST POINT; PIN DIA = 0.125IN; TOTAL LENGTH = 0.35IN; BOARD HOLE = 0.063IN; RED; PHOSPHOR BRONZE WIRE SILVER PLATE FINISH; RECOMMENDED FOR BOARD THICKNESS = 0.062IN
25	1	PCB	-	EPCBM17537	MAXM17537	MAXIM	PCB	PCB:MAXM17537
TOTAL	51							

DO NOT PURCHASE(DNP)

ITEM	QTY	REF DES	VAR STATUS	MAXINV	MFG PART #	MANUFACTURER	VALUE	DESCRIPTION
1	1	C1	DNP	EC111000001494	C1608C0G2A221J080AA	TDK	220PF	CAP; SMT (0603); 220PF; 5%; 100V; COG; CERAMIC CHIP
2	5	C5, C6, C20-C22	DNP	20-004U7-08C	GRM31CZ72A475KE11	MURATA	4.7UF	CAP; SMT (1206); 4.7UF; 10%; 100V; X7R; CERAMIC CHIP ; NOTE:PURCHASE DIRECT FROM THE MANUFACTURER
3	1	C12	DNP	20-0010U-B40	GRM32ER71H106KA12; CL32B106KBJNNN; UMJ325KB7106KMH; 12105C106K4Z2A	MURATA; SAMSUNG ELECTRONICS; TAIYO YU	10UF	CAPACITOR; SMT (1210); CERAMIC CHIP; 10µF; 50V; TOL = 10%; TG = -55°C TO +125°C; TC = X7R
4	1	C23	DNP	20-000U1-01	CC0603KRX7R0BB104; GRM188R72A104KA35; GCJ188R72A104KA01; HMK107B7104KA; 06031C104KAT2A	YAGEO; MURATA; MURATA; TAIYO YUDEN; AVX	0.1UF	CAPACITOR; SMT (0603); CERAMIC CHIP; 0.1µF; 100V; TOL = 10%; TG = -55°C TO +125°C; TC = X7R
5	1	L1	DNP	50-008U2-OFF	XAL5050-822ME	COILCRAFT	8.2UH	INDUCTOR; SMT; SHIELDED; 8.2UH; TOL = ±20%; 4.5A
TOTAL	9							

PACKOUT (These are purchased parts but not assembled on PCB and will be shipped with PCB)

ITEM	QTY	REF DES	Var Status	MAXINV	MFG PART #	MANUFACTURER	VALUE	DESCRIPTION
TOTAL	0							

MAXM17537EVKIT# Schematic Diagram

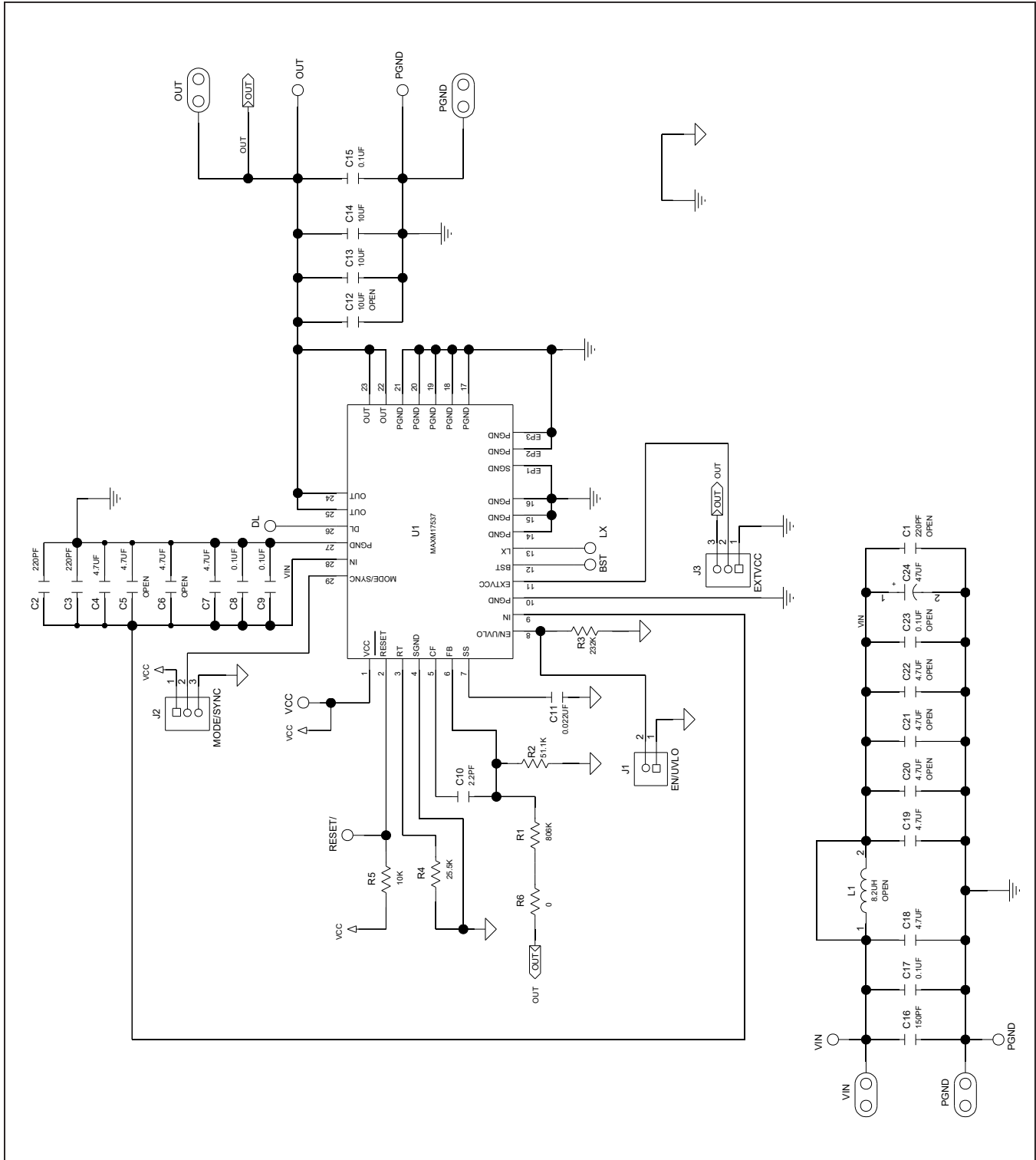

MAXM17537 15V Output Evaluation Kit

Evaluates: MAXM17537 15V Output

MAXM17537EVKIT# PCB Layout Diagrams

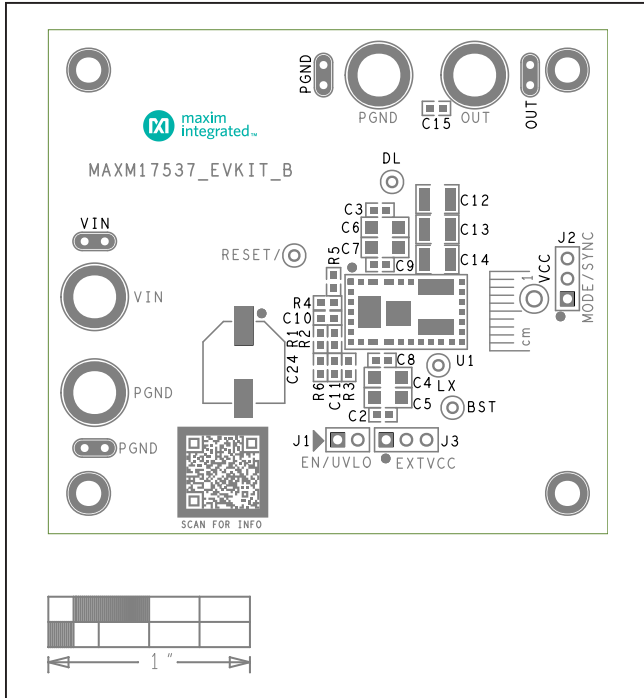

MAXM17537 EV Kit—Top Silkscreen

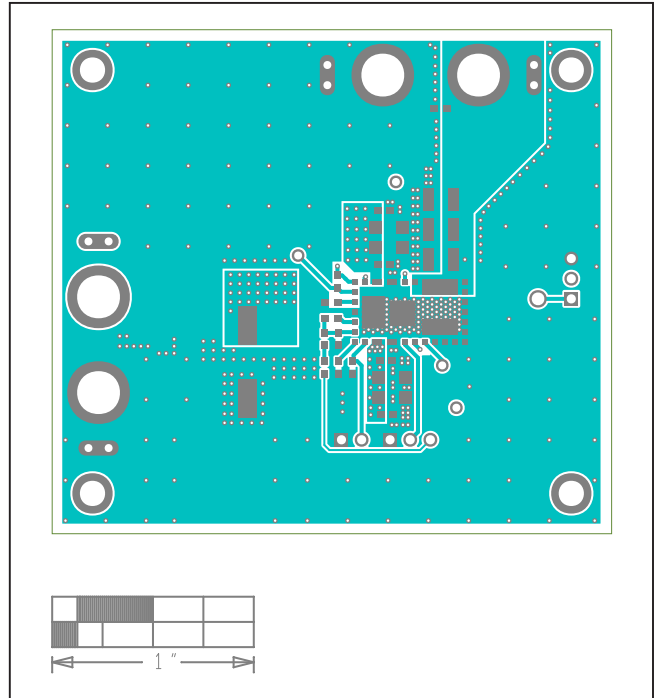

MAXM17537 EV Kit—Top Layer

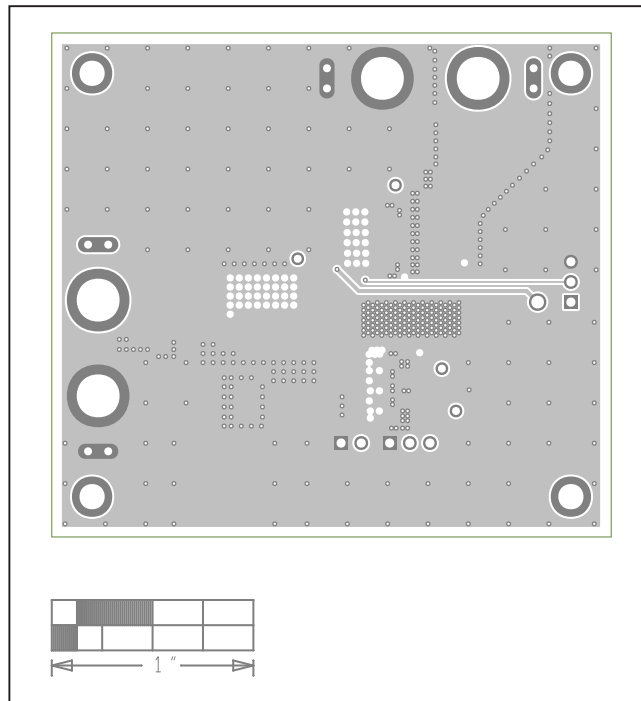

MAXM17537 EV Kit—Layer 2

MAXM17537EVKIT# PCB Layout Diagrams (continued)

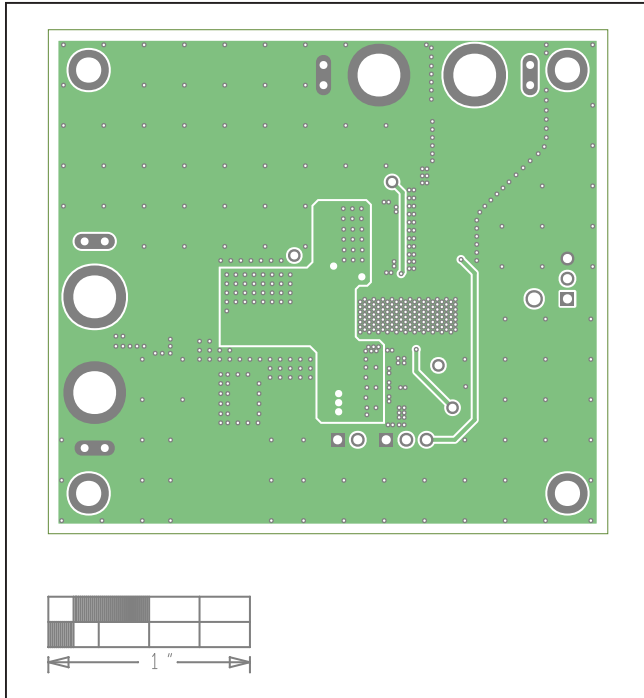

MAXM17537 EV Kit—Layer 3

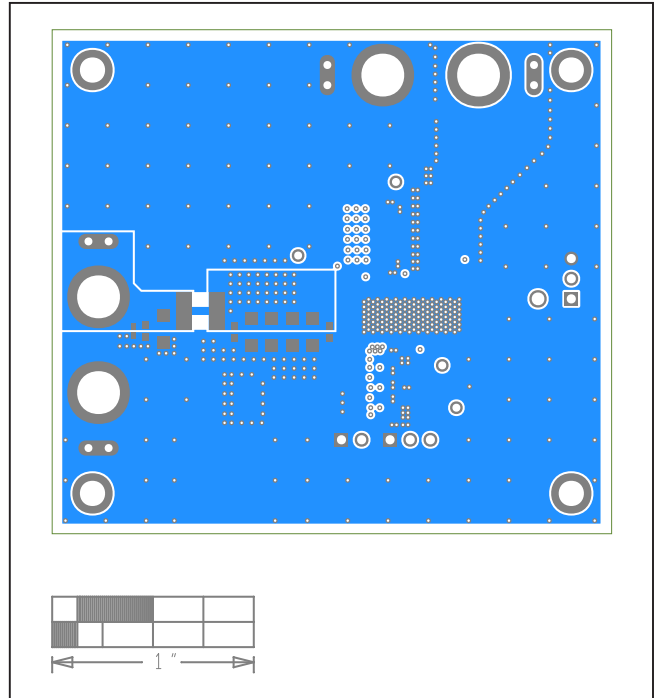

MAXM17537 EV Kit—Bottom Layer

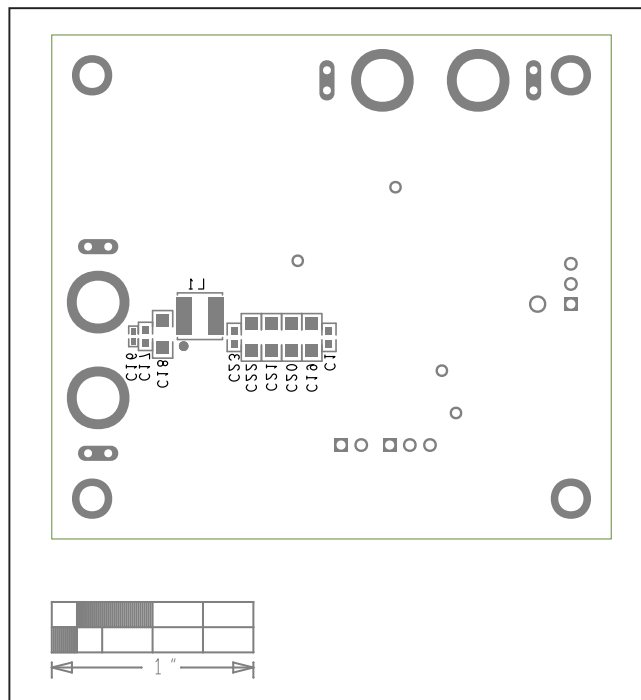

MAXM17537 EV Kit—Bottom Silkscreen

Revision History

REVISION NUMBER	REVISION DATE	DESCRIPTION	PAGES CHANGED
0	10/19	Initial release	—

For pricing, delivery, and ordering information, please visit Maxim Integrated's online storefront at <https://www.maximintegrated.com/en/storefront/storefront.html>.

Maxim Integrated cannot assume responsibility for use of any circuitry other than circuitry entirely embodied in a Maxim Integrated product. No circuit patent licenses are implied. Maxim Integrated reserves the right to change the circuitry and specifications without notice at any time.