

# MU Type Optical In-Line Attenuators

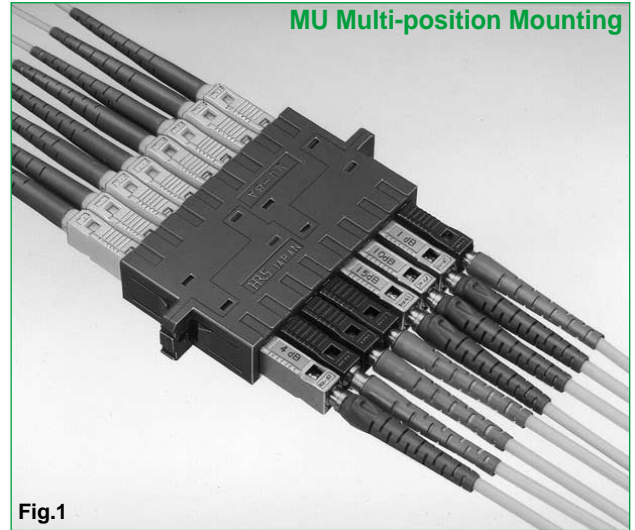
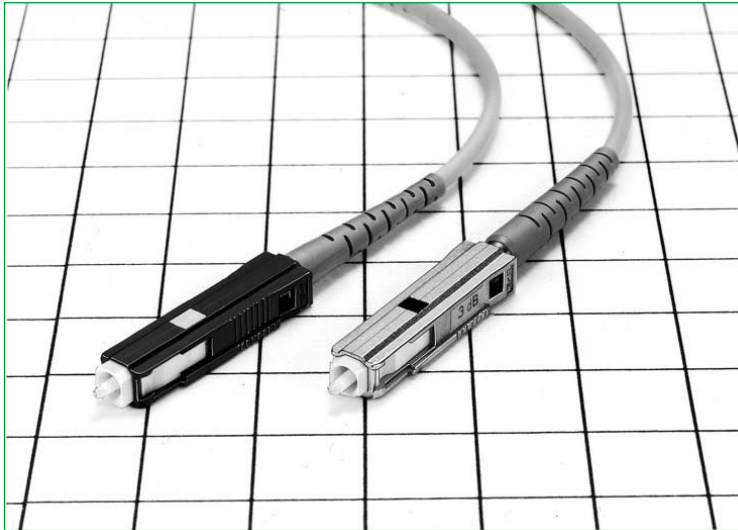

Fig.1

## ■ Features

### 1. Smaller package

Hirose's original design combines a plug and attenuator into the same connector size of a standard MU plug, and the superior design enable to save a space using 4.5 mm pitch MU multiple adapters as shown in Fig. 1 and 2.

### 2. Easy to Change attenuation level

Easy to change the attenuation level with a simple push-twist lock as shown in Fig.3(See page 80). 15 levels of attenuation are currently available : 0,1,2,3,4,5,6,7,8,9,10,12.5,15,17.5,and 20 dB

### 3. Insertion and extraction tool

The MU standard tool is available as shown in Fig. 4.

### 4. Maximum input power :100mW

### 5. Please contact us if you have any requests. Hirose will offer excellent solutions to meet your requirements.

## ■ Applications

Power level adjustment of optical fiber communication networks.

### Save 16.7mm space

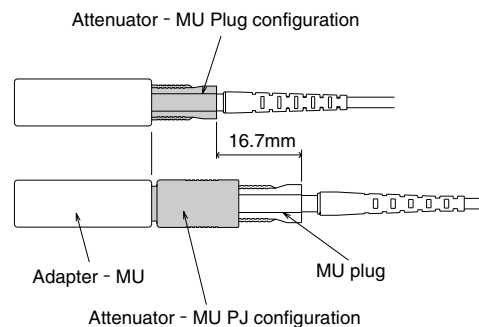

Fig.2

### Easy to change an attenuation part

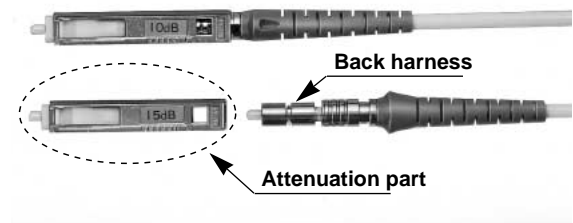

Fig.3

### MU standard tool is available

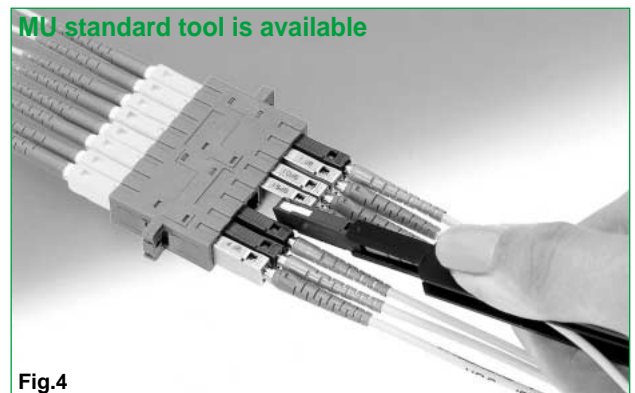

Fig.4

## Product Specifications

Ratings	Operation temperature range	-25°C to +70°C	Storage temperature range	-25°C to +70°C
	Max. Input Power	100mW	Fiber type	SM

Item		Test Method	Specifications	
Optical Characteristics	Attenuation	Measurement at a point within the wavelength of 1310 ± 30 nm, and a point within the wavelength of 1550 ± 30 nm.	Attenuation Tolerance	
			0dB	≤0.5dB
1,2dB			±0.5dB	
3,4,5,6dB			±0.8dB	
7,8,9dB			±1.0dB	
10dB			±1.2dB	
	Return Loss(R.L.)		≥40dB	
Mechanical Characteristics	Engagement and separation forces	Engagement and separation forces at 50mm/s.	Engagement force: ≤12.5 N Separation force: ≤12.5 N	
	Gauge retention force	Zirconia gauge at φ1.249 ± 0.0005 mm.	1.0N to 2.5N	
	Mating durability	Insertion and extraction number for connectors:500 Insertion and extraction number for an attenuation element:50	1) Attenuation shall be satisfied after the test. 2) No breakage, crack or looseness on components.	
	Vibration	For 3 hours at an amplitude of 1.5mm. with the frequency range 10 to 55Hz. In each of three mutually perpendicular plane.		
Shock	3 times in each of three mutually perpendicular axis with the acceleration 981m/s <sup>2</sup> .			
Environmental Characteristics	Compassite Temperature-humidity Cyclic test	Humidity : 90% to 96% Temperature : -10°C to 65°C, Cyclic : 10 cycles(240 hours)		
	Temperature cycling	Temp : 25 → -25 → -25 → 70 → 70 → 25°C Time : 15 30 30 30 15 min Cyclic : 10 cycles		
	Dry heat	Temperature : 85°C      Time : 500 hours		
	Cold	Temperature : -25°C      Time : 500 hours		
	Salt Mist	Salt Mist : 5%      Time : 48 hours	No significant corrosion.	

## Materials

Part	Material
Body	Zinc alloy
Ferrule	Zirconia
Split sleeve	Zirconia

## Ordering Information

**HMU - PAT - FH - K 1 01**

①      ②      ③      ④ ⑤ ⑥

① Series name	: HMU
② Indicates a in-line type attenuator	
③ Indicates the attenuation part	
④ Polishing type	K:AdPC
⑤ Applicable optical fiber	1:SM
⑥ Attenuation	00:0 dB (Through)12:12.5dB,17:17.5dB 01 to N: Attenuation (dB)

Note: This attenuator is used only with the cable assembly shown on the next page.

## In-line attenuators

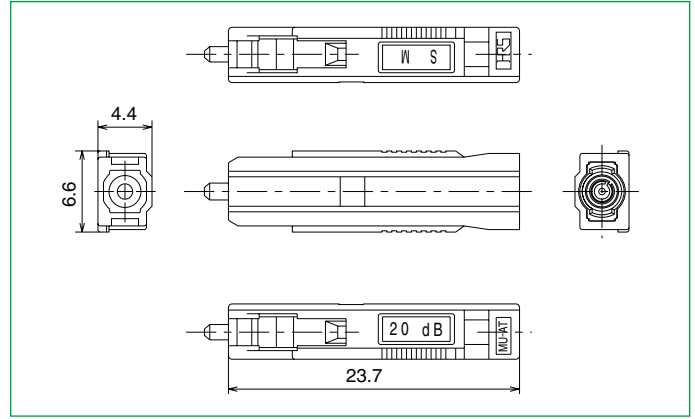

Part Number	CL No.	Attenuation	Specification	Return loss	Wavelength	Split sleeve	Fiber type
HMU-PAT-FH-K100	827-0001-8	0 dB	0.5dB max.	≥40dB	1310nm 1550nm	Zirconia	SM
HMU-PAT-FH-K101	827-0002-0	1 dB	±0.5dB				
HMU-PAT-FH-K102	827-0003-3	2 dB	±0.8dB				
HMU-PAT-FH-K103	827-0004-6	3 dB					
HMU-PAT-FH-K104	827-0005-9	4 dB					
HMU-PAT-FH-K105	827-0006-1	5 dB	±1dB				
HMU-PAT-FH-K106	827-0007-4	6 dB					
HMU-PAT-FH-K107	827-0011-1	7 dB					
HMU-PAT-FH-K108	827-0012-4	8 dB	±1.2dB				
HMU-PAT-FH-K109	827-0013-7	9 dB					
HMU-PAT-FH-K110	827-0008-7	10 dB					
HMU-PAT-FH-K112	827-0014-0	12.5dB	±ATT×10%dB				
HMU-PAT-FH-K115	827-0009-0	15 dB					
HMU-PAT-FH-K117	827-0015-2	17.5dB					
HMU-PAT-FH-K120	827-0010-9	20 dB					

## Back Cable Assembly (2mm diameter cable type)

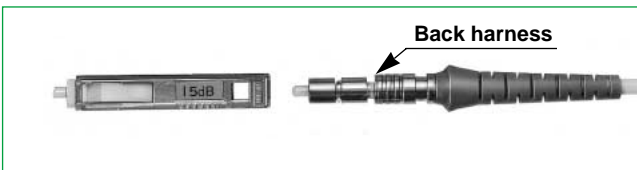

The back cable assembly is supplied by Hirose.

Please contact your Hirose sales representative for details concerning your back cable needs, including cable length and mating connector requirements.

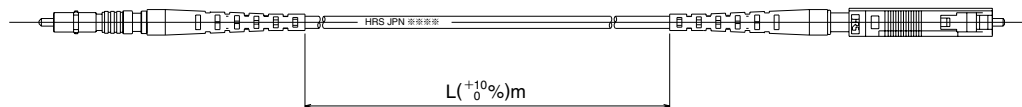

## Ordering Information (Back cable assembly)

**HMU - PAT BH 101 K Q - L**

①      ②      ③      ④      ⑤      ⑥      ⑦

① Series Name HMU	⑤ Polishing type K: AdPC
② Indicates a in-line type attenuator	⑥ Fiber cable type(Note)
③ Indicate a back cable assembly	Q: SM-9.5/125, diameter 2mm Jacket color: Yellow
④ Mating connector (Note)	⑦ Cable length
011 : FC connector, 2 mm diameter cable	Unit: Meters
04G : SC connector, 2 mm diameter cable	
101 : MU connector, 2 mm diameter cable	

Note: These are examples of offered cable assemblies. They will differ depending on the applicable cable diameter and the type of boot. For exact cable assembly specifications, specify the connector type at the mating side and the required total length. Contact your Hirose Electric account representative.

## ◆ Procedure for Changing the Attenuator Element

### Insertion Procedure



- 1 Align the triangle mark of the boot on the back cable assembly with the black indexing mark on the attenuator.

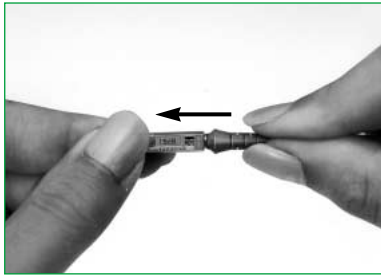

- 2 Insert the back cable assembly into the attenuator.

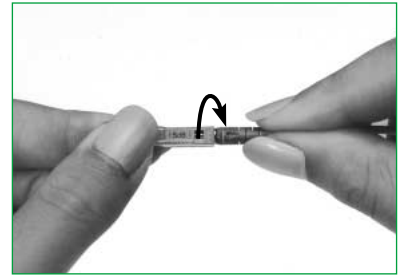

- 3 Turn right the back cable assembly to engage connection lock. After turning, the triangle mark of the boot will be aligned with the attenuation label.

### Withdrawal Procedure

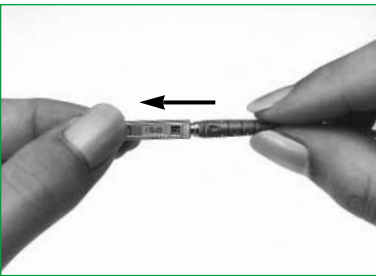

- 1 Press the back cable assembly toward the attenuator.

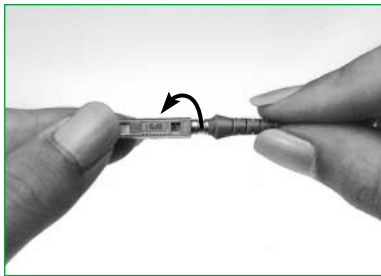

- 2 Turn right the back cable assembly and release the lock.

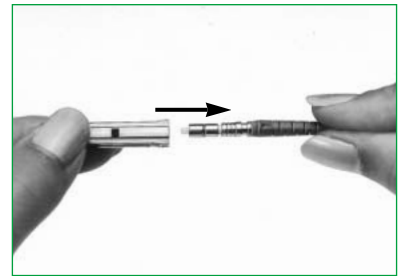

- 3 Pull away the back cable assembly.