

Mini-G series

Ultra Compact for built-in Use
Embedded Amplifier Photo Sensors



- Ultra-compact size used for built-in use for over 25 years
- Various types such as head-on, wide diffuse reflective, high power or convergent reflective
- M3 threaded screw can be used for all models
- Water resistance complying with IP67
- Stability output is included standard
 - High-power light transmitting business cards: GT1SN, GT1N
 - Long detecting distance of 10 m: GT3RSN
 - High-performance detection at a short distance: GS5SN, GS5N
 - Less affected by background: limited reflection type
 - Easy light axis alignment: red LED type

Type

Detection method	Detecting distance	Model		Operation mode	Output mode
		Side-on type	Head-on type		
Through beam ↑	1 m	GT1SN	—	Light-ON/ Dark-ON selectable (with switch)	NPN Open collector output
		GT1SPN	—		PNP Open collector output
	7 m	—	GT1N		NPN Open collector output
		—	GT1PN		PNP Open collector output
	10 m	—	GT3N		NPN Open collector output
		—	GT3PN		PNP Open collector output
	7 m	GT3RSN	—		NPN Open collector output
		GT3RSPN	—		PNP Open collector output
0.01 - 2 m	GT7SN	—	NPN Open collector output		
	GT7SPN	—	PNP Open collector output		
Retroreflective ↑↓	0.01 - 2 m	GSM2RSN	—		NPN Open collector output
		GSM2RSPN	—		PNP Open collector output
Diffuse reflective ↑↓	70 mm	GS5SN	—		NPN Open collector output
		GS5SPN	—		PNP Open collector output
	400 mm	—	GS5N		NPN Open collector output
		—	GS5PN		PNP Open collector output
	300 mm	GS20RSN	—		NPN Open collector output
		GS20RSPN	—		PNP Open collector output
	300 mm	—	GS20RN		NPN Open collector output
		—	GS20RPN		PNP Open collector output
	200 mm	GS20SN	—		NPN Open collector output
		GS20SPN	—		PNP Open collector output
Convergent reflective ∇	1 - 40 mm	—	GS20N		NPN Open collector output
		—	GS20PN		PNP Open collector output
	3 - 30 mm	GSZ3SN	—	NPN Open collector output	
		GSZ3SPN	—	PNP Open collector output	
3 - 30 mm	GSZ3RSN	—	NPN Open collector output		
	GSZ3RSPN	—	PNP Open collector output		

Optional Parts

Type	Model	Pinhole diameter	Applicable model and detecting distance <small>(attached to both transmitter and receiver)</small>
Pinhole plate (SUS)	GP1	φ 1mm	GT3RSN400mm
			GT7SN300mm
	GP2	φ 2mm	GT3RSN1m
			GT7SN1m
GP3	φ 3mm	GT3RSN3m	
		GT7SN2.5m	
GP5-1	5 x 1mm	GT3RSN2m	
		GT7SN1.7m	

(Models GT1N and GT1SN are provided with stick-on pinhole sheets.)

(Detecting distance when pinhole plates are mounted on both transmitter and receiver)

Type of pinhole plate <small>(attached to GT1N or GT1SN)</small>	φ 1mm	φ 2mm	φ 3mm	5×1 mm
Detecting distance	100 mm	300 mm	400 mm	300 mm

• Installation of pinhole plate

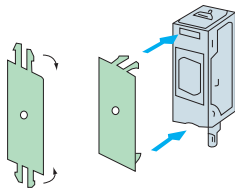

Bend the top and bottom parts at the base and insert the bent parts into the sensor slits.

Type	Model	Description	
Protective cover	GN-PCB1	For side-on type	Durable stainless steel cover to protect the sensor and reflector from impact.
	GN-PCB2		
	G-K7B	For retroreflector (K-7 or K-71)	See page 195.

Typical Application

This sensor detects vibrations or reflections in the string.

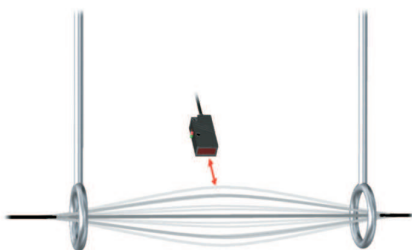

• Applicable power supply unit

PS series
High capacity of 200 mA at 12 VDC



(General-purpose type) PS3N
PS3N-SR
(Multifunctional type) PS3F
PS3F-SR

Mini-G

Rating/Performance/Specification

Type	Side-on	NPN output	GT1SN	—	GT3RSN	GT7SN	GSM2RSN	GS5SN	GS20RSN	GS20SN	GSZ3N	GSZ3RSN
		PNP output	GT1SPN	—	GT3RSPN	GT7SPN	GSM2RSPN	GS5SPN	GS20RSPN	GS20SPN	GSZ3SPN	GSZ3RSPN
Head-on	NPN output		GT1N	GT3N				GS5N	GS20RN	GS20N		
	PNP output		GT1PN	GT3PN				GS5PN	GS20RPN	GS20PN		
Detection method		Through beam				Retroreflective	Diffuse reflective			Convergent reflective		
Detecting distance		1m	7m	10m	7m	0.01~2 m (When used with K-71 reflector)	70 mm (50 x 50 mm white drawing paper)	400 mm (GS20RSN) 300 mm (GS20RN) (100 x 100 mm white drawing paper)	300 mm (GS20SN) 200 mm (GS20N) (100 x 100 mm white drawing paper)	1~40 mm (50 x 50 mm white drawing paper)	3~30 mm (50 x 50 mm white drawing paper)	
Detection object		φ6mm (or more) Opaque				φ40mm (or more) Opaque	Opaque, translucent, transparent					
Power supply		12-24V DC ±10% / Ripple 10% or less										
Current consumption	NPN output	Transmitter: 23mA or less Receiver: 18mA or less				20mA or less	25mA or less	20mA or less	22mA or less	20mA or less		
	PNP output	Transmitter: 23mA or less Receiver: 21mA or less				25mA or less	28mA or less	25mA or less				
Output mode	Control output	NPN open collector output Rating: sink current 100mA (30 VDC) or less				PNP open collector output Rating: source current 100mA (30 VDC) or less						
	Stability output	NPN open collector output Rating: sink current 50mA (30 VDC) or less				PNP output type does not have stability output						
Operation mode		Light-ON/Dark-ON selectable (with switch)										
Response time		0.35ms or less										
Hysteresis		10% or less										
Operating angle		30° (at receiver)	10° (at receiver)			30° (at reflector)						
Light source (light wavelength)		Infrared LED (880nm)	Red LED (700nm)	Infrared LED (880nm)	Red LED (700nm)	Infrared LED (900nm)	Red LED (700nm)	Infrared LED (900nm)	Red LED (700nm)			
Indicator		Transmitter: Power indicator (red LED) Receiver: Operation indicator (red LED) Stability indicator (green LED)				Operation indicator (red LED) Stability indicator (green LED)						
Volume		SENS: Sensitivity adjustment (on receiver for through-beam type)										
Switch		Light-ON/Dark-ON selector switch provided										
Short circuit protection		Provided (for control output only)										
Material	Case	Polyarylate										
	Lens	Polycarbonate	Polyarylate			Polycarbonate	Polyarylate		Polycarbonate	Acrylic		
Connection	NPN output	Cable type (outer diameter: 3mm; length 2m) Transmitter: 0.15mm ² x 2 cores (gray) Receiver: 0.15mm ² x 3 cores (black)				Cable type (outer diameter: 3mm; length 2m) 0.15mm ² x 4 cores (black)						
	PNP output	Cable type (outer diameter: 3mm; length 2m) Transmitter: 0.15mm ² x 2 cores (gray) Receiver: 0.15mm ² x 3 cores (black)				Cable type (outer diameter: 3mm; length 2m) 0.15mm ² x 3 cores (black)						
Weight		Approx. 50 g (transmitter/receiver)				Approx. 50g						
Accessories		Pinhole sheets provided				K-71 reflector			Mounting bracket, operation manual provided			

Environmental Specification

Ambient light	5,000 lx or less
Ambient temperature	-25 - +55°C (non-freezing)
Ambient humidity	35-85%RH (non-condensing)
Protective structure	IP67
Vibration	10-55 Hz / 1.5 mm double amplitude / 2 hours each in 3 direction
Shock	500 m/s ² / 3 times each in 3 directions
Dielectric strength	1,000 VAC for 1 minute
Insulation resistance	500 VDC, 20 MΩ or higher

* Detecting distances for different reflectors

The detecting distance depends on the reflector used.

Reflector model	K-71	K-7	S-25
Detecting distance	0.01 - 2m	0.01 - 3m	70 - 400mm

The detecting distance is the range which you can set for the reflector. The sensor can detect an object even in extremely short range.

Input/Output Circuit and Connection

• NPN output

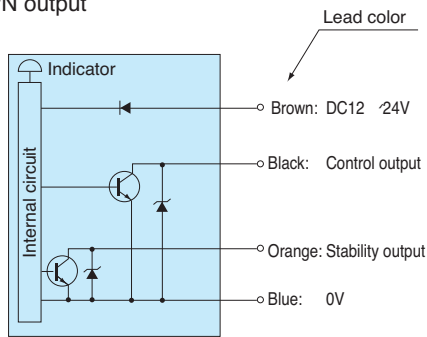

• PNP output

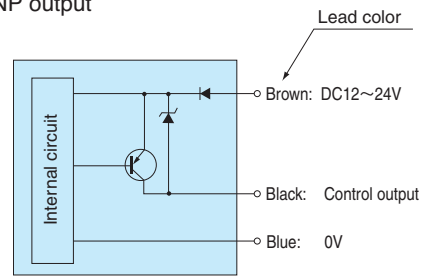

(PNP output models are not equipped with stability output.)

- The transmitter is provided with power supply lines (brown: 12 - 24 VDC; blue: 0 V) only.
- The output transistor turns off when load short circuit or overload occurs. Check the load and turn the power back on.

Switching the operation mode

- All models have the operation mode selector.

Light-ON mode

Dark-ON mode



For the Light-ON mode, turn to L.
For the Dark-ON mode, turn to D.

Performance Curves (Typical)

• Response Curves : Beam Pattern

GT1SN·GT1N

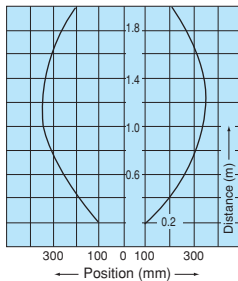

GT3N·GT7SN

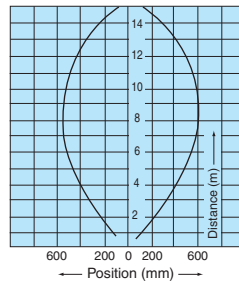

GT3RSN

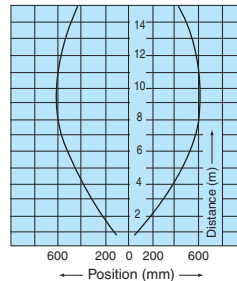

GSM2RSN (K-71)

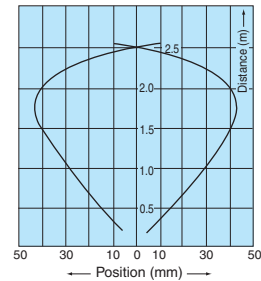

• Response Curves : Tilt Angle

GT1SN·GT1N

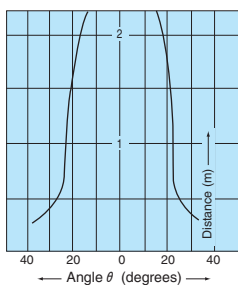

GT3N·GT7SN

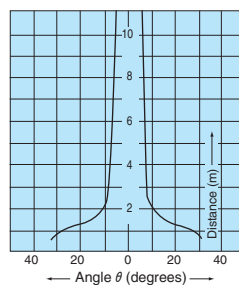

GT3RSN

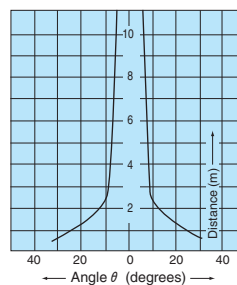

GSM2RSN (K-71)

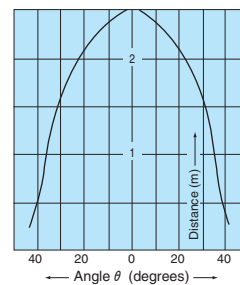

Mini-G

● Response Curves : Detecting Position

GS5SN

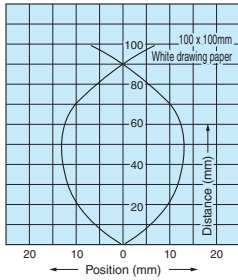

GS5N

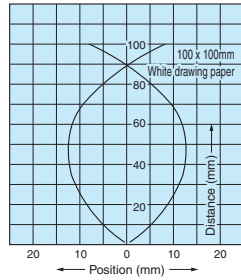

GS20RSN

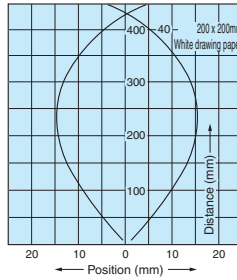

GS20RN

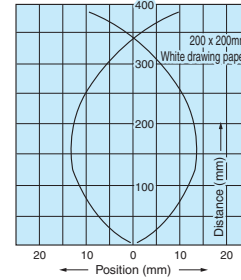

GS20N

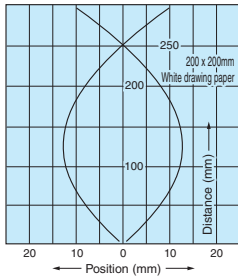

GS20SN

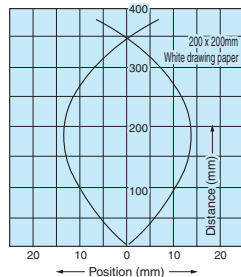

GSZ3SN

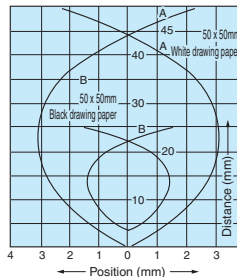

GSZ3RSN

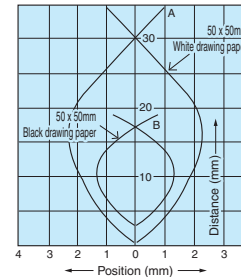

● Response Curves : Target Size

GS5SN

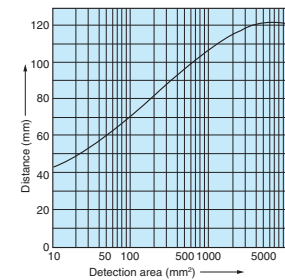

GS5N

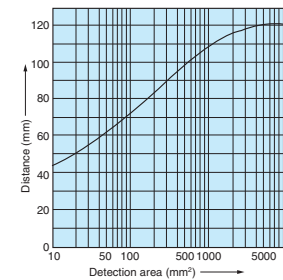

GS20RN

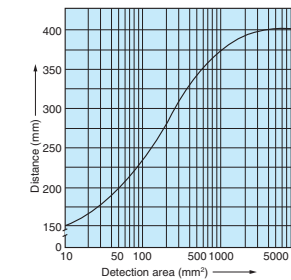

GS20RSN

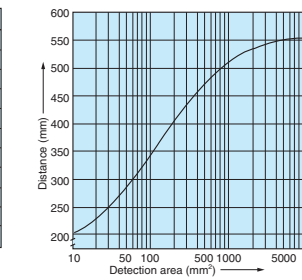

GS20N

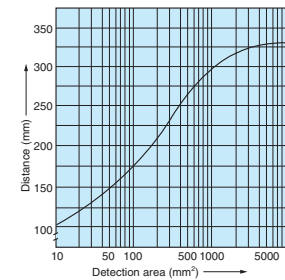

GS20SN

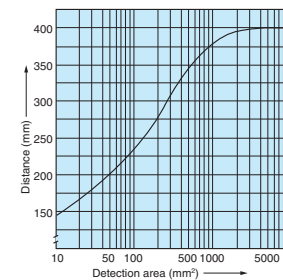

● Response Curves : Ambient Temperature

Reflective type

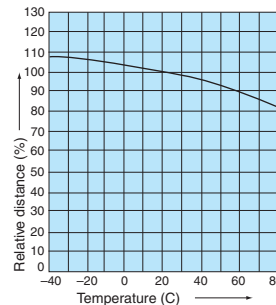

Through beam type

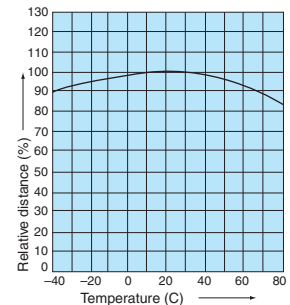

Dimensions (in mm; tightening torque for mounting screws: 0.6 N·m max.)

Side-on type

CAD

GT1SN
GT3RSN
GT7SN
GS5SN
GSM2RSN
GS20RSN
GS20SN
GSZ3SN
GSZ3RSN

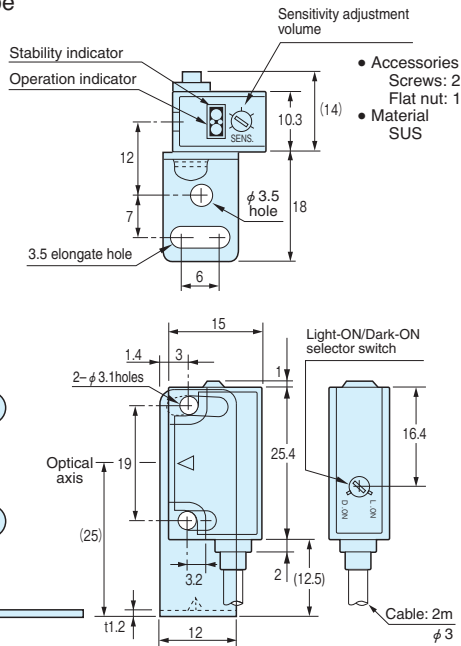

*Figures above show receivers. Transmitters have different panels.

Head-on type

CAD

GT1N
GT3N
GS5N
GS20N
GS20RN

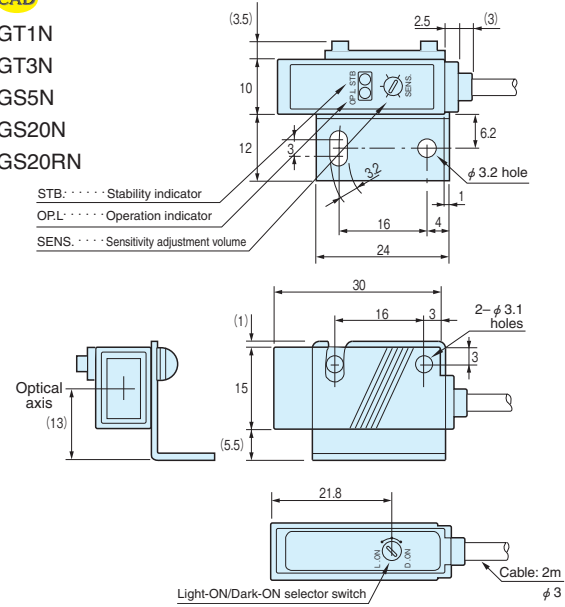

*Figures above show receivers. Transmitters have different panels.

Reflector

CAD

K71

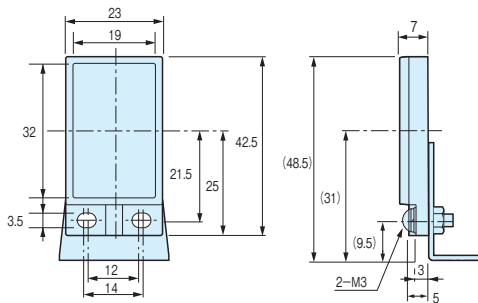

(Applicable to polarized retroreflective type
Effective reflecting surface: 30 x 18 mm
Mounting: mounting bracket provided, secured with M3 screws (alternatively adhesive may be used))

Stability output

The stability output can be used to check for reduction of the light intensity level along with any change in the operating environment or operation over time or to perform initial check of the operation. When two consecutive detections have occurred with the intensity of light detected exceeding the operation level but not reaching 120% of the level (range allowing stable operation), the stability signal is output when the control output is deactivated. (This output is not available with the PNP output types of the Mini-G Series.)

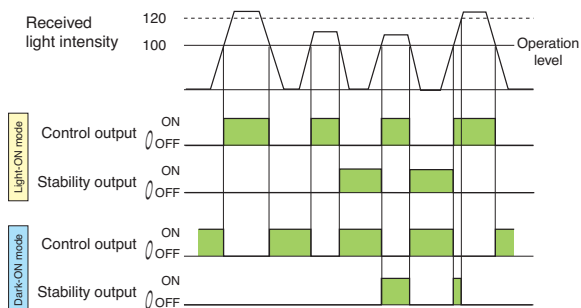

Indicators

- The operation indicator (red LED) and stability indicator (green LED) each show different received light intensity levels as described in the figure.
- After aligning the optical axis and adjusting the sensitivity, make sure the light received and the light blocked is within the stable ranges by blocking and unblocking the lights with a detection object repeatedly. Setting within the stable range increases reliability against differences in the environment after installation.

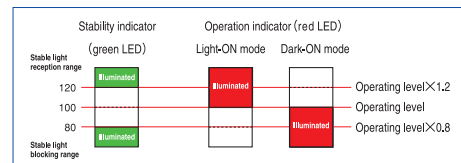

- The orange LED is the operation indicator. For the light ON mode, the indicator is illuminated when the light is detected. For the dark ON mode, the indicator is illuminated when the light is blocked.

Sensitivity adjustment (for Light-ON mode)

(Adjustment for Light-ON mode)

- When any light-reflecting object is in the background
 - Place the object to be detected in a given position, turn up the sensitivity adjustment volume (SENS.) gradually and find the point at which the operation indicator (red LED) is illuminated (Point A).
 - Remove the object, turn down the sensitivity adjustment volume gradually from MAX. and find the point at which the operation indicator (red LED) goes out (Point B). (If the operation indicator is not illuminated even at Max., MAX. is regarded as Point B.)
 - Set the volume at midway between Points A and B.

