



DDR SDRAM DIMM MODULE

MT4VDDT1632U – 64MB MT4VDDT3232U – 128MB

For the latest data sheet, please refer to the Micron[®] Web site: www.micron.com/modules

Features

- 100-pin, dual in-line memory module (DIMM)
- Fast data transfer rate PC2100 and PC2700
- Utilizes 266 MT/s or 333 MT/s DDR SDRAM components
- 64MB (16 Meg x 32) and 128MB (32 Meg x 32)
- VDD = VDDQ = +2.5V
- 2.5V I/O (SSTL_2 compatible)
- Commands entered on each positive CK edge
- DQS edge-aligned with data for READs; center-aligned with data for WRITEs
- Internal, pipelined double data rate (DDR) architecture; two data accesses per clock cycle
- Bidirectional data strobe (DQS) transmitted/received with data—*i.e.*, source-synchronous data capture
- Differential clock inputs CK and CK#
- Four internal device banks for concurrent operation
- Programmable burst lengths: 2, 4, or 8
- Auto precharge option
- Serial Presence Detect (SPD) with EEPROM
- Programmable READ CAS latency
- Auto Refresh and Self Refresh Modes
15.625 μ s (64MB), 7.8125 μ s (128MB) maximum average periodic refresh interval

Figure 1: 100-Pin DIMM (MO-161)

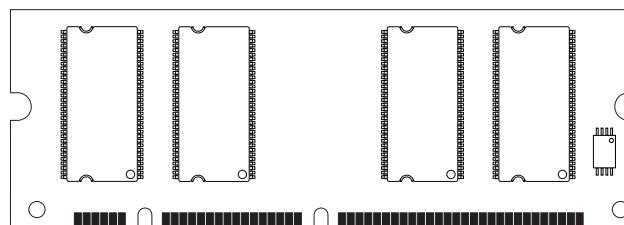

OPTIONS

- Package
100-pin DIMM (gold)
- Frequency/CAS Latency
6ns/167 MHz (333MT/s) CL = 2.5
7.5ns/133 MHz (266 MT/s) CL = 2.5

MARKING

G
-6
-75

Table 1: Address Table

	MT4VDDT1632U	MT4VDDT3232U
Refresh Count	4K	8K
Row Addressing	8K (A0–A11)	8K (A0–A12)
Device Bank Addressing	4 (BA0, BA1)	4 (BA0, BA1)
Device Configuration	16 Meg x 8	32 Meg x 8
Column Addressing	1K (A0–A9)	1K (A0–A9)
Module Rank Addressing	1 (S0#)	1 (S0#)

Table 2: Part Numbers and Timing Parameters

PART NUMBER	MODULE DENSITY	CONFIGURATION	MODULE BANDWIDTH	MEMORY CLOCK/ DATA BIT RATE	LATENCY (CL - ^t RCD - ^t RP)
MT4VDDT1632UG-6__	64MB	16 Meg x 32	2.7 GB/s	6ns/333 MT/s	2.5-3-3
MT4VDDT1632UG-75__	64MB	16 Meg x 32	2.1 GB/s	7.5ns/266 MT/s	2.5-3-3
MT4VDDT3232UG-6__	128MB	32 Meg x 32	2.7 GB/s	6ns/333 MT/s	2.5-3-3
MT4VDDT3232UG-75__	128MB	32 Meg x 32	2.1 GB/s	7.5ns/266 MT/s	2.5-3-3

NOTE:

All part numbers end with a two-place code (not shown), designating component and PCB revisions. Consult factory for current revision codes. Example: MT4VDDT1632UG-75B1



Table 3: Pin Assignment (100-Pin DIMM Front)

PIN	SYMBOL	PIN	SYMBOL	PIN	SYMBOL	PIN	SYMBOL
1	DQ0	14	VDD	26	A5	39	DQ18
2	VSS	15	DQ11	27	A3	40	DQ19
3	DQ1	16	VSS	28	A1	41	VDD
4	DQS0	17	CK0	29	A10	42	DQ24
5	VDD	18	CK0#	30	VDD	43	DQ25
6	DQ2	19	VDD	31	BA0	44	VSS
7	DQ3	20	NC	32	WE#	45	DQS3
8	VDD	21	NC/A12	33	S0#	46	DQ26
9	DQ8	22	NC	34	DQ16	47	VSS
10	DQ9	23	A9	35	VSS	48	DQ27
11	VSS	24	A7	36	DQ17	49	SA0
12	DQS1	25	VSS	37	DQS2	50	VREF
13	DQ10			38	VDD		

Table 4: Pin Assignment (100-Pin DIMM Back)

PIN	SYMBOL	PIN	SYMBOL	PIN	SYMBOL	PIN	SYMBOL
51	DQ4	64	VDD	76	A2	89	DQ22
52	VSS	65	DQ15	77	A0	90	DQ23
53	DQ5	66	VSS	78	BA1	91	VDD
54	DM0	67	DNU	79	RAS#	92	DQ28
55	VDD	68	DNU	80	VDD	93	DQ29
56	DQ6	69	VDD	81	CAS#	94	VSS
57	DQ7	70	CKE0	82	NC	95	DM3
58	VDD	71	A11	83	DNU	96	DQ30
59	DQ12	72	A8	84	DQ20	97	VSS
60	DQ13	73	A6	85	VSS	98	DQ31
61	VSS	74	A4	86	DQ21	99	SDA
62	DM1	75	VSS	87	DM2	100	SCL
63	DQ14			88	VDD		

NOTE:

Pin 21 is No Connect for the 64MB module, or A12 for the 128MB module.

Figure 2: Module Layout

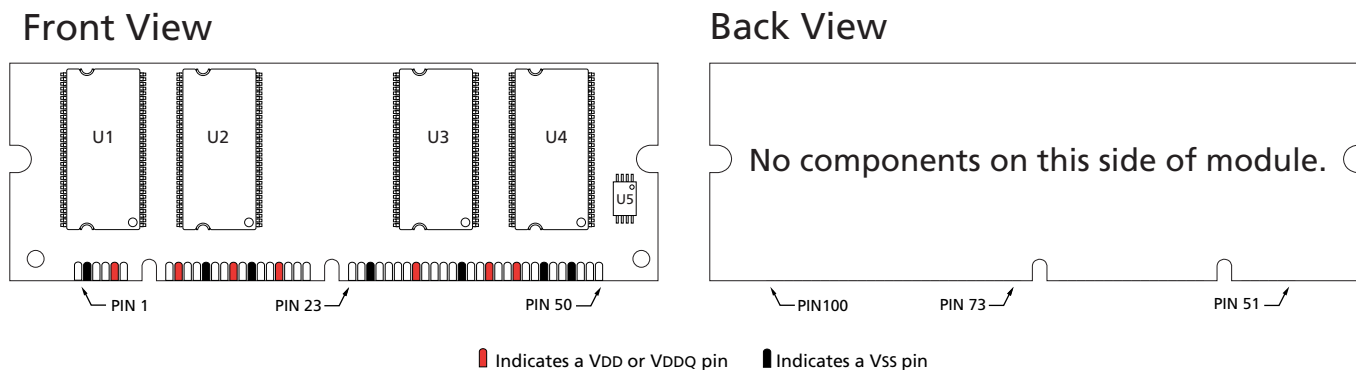



Table 5: Pin Descriptions

Pin numbers may not correlate with symbols. Refer to Pin Assignment Tables for pin number and symbol information

PIN NUMBERS	SYMBOL	TYPE	DESCRIPTION
50	VREF	Input	SSTL_2 reference voltage.
32, 79, 81	WE#, CAS#, RAS#	Input	Command Inputs: RAS#, CAS#, and WE# (along with S#) define the command being entered.
17, 18	CK0, CK0#	Input	Clock: CK, CK# are differential clock inputs. All address and control input signals are sampled on the crossing of the positive edge of CK, and negative edge of CK#. Output data (DQ and DQS) is referenced to the crossings of CK and CK#.
70	CKE0	Input	Clock Enable: CKE HIGH activates and CKE LOW deactivates the internal clock, input buffers and output drivers. Taking CKE LOW provides PRECHARGE POWER-DOWN and SELF REFRESH operations (all device banks idle), or ACTIVE POWER-DOWN (row ACTIVE in any device bank). CKE is synchronous for POWER-DOWN entry and exit, and for SELF REFRESH entry. CKE is asynchronous for SELF REFRESH exit and for disabling the outputs. CKE must be maintained HIGH throughout read and write accesses. Input buffers (excluding CK, CK#, and CKE) are disabled during POWER-DOWN. Input buffers (excluding CKE) are disabled during SELF REFRESH. CKE is an SSTL_2 input but will detect an LVCMOS LOW level after VDD is applied.
33	S0#	Input	Chip Selects: S# enables (registered LOW) and disables (registered HIGH) the command decoder. All commands are masked when S# is registered HIGH. S# is considered part of the command code.
31, 78	BA0, BA1	Input	Bank Address: BA0 and BA1 define to which device bank an ACTIVE, READ, WRITE, or PRECHARGE command is being applied.
21 (128MB), 23, 24, 26-29, 71-74, 76, 77	A0-A11 (64MB) A0-A12 (128MB)	Input	Address Inputs: Provide the row address for ACTIVE commands, and the column address and auto precharge bit (A10) for READ/WRITE commands, to select one location out of the memory array in the respective device bank. A10 sampled during a PRECHARGE command determines whether the PRECHARGE applies to one device bank (A10 LOW, device bank selected by BA0, BA1) or all device banks (A10 HIGH). The address inputs also provide the op-code during a MODE REGISTER SET command. BA0 and BA1 define which mode register (mode register or extended mode register) is loaded during the LOAD MODE REGISTER command.
4, 12, 37, 45	DQS0-DQS3	Input/ Output	Data Strobe: Output with READ data, input with WRITE data. DQS is edge-aligned with READ data, centered in WRITE data. Used to capture data.
54, 62, 87, 95	DM0-DM3	Input	Data Write Mask. DM LOW allows WRITE operation. DM HIGH blocks WRITE operation. DM lines do not affect READ operation.
1, 3, 6, 7, 9, 10, 13, 15, 34, 36, 39, 40, 42, 43, 46, 48, 51, 53, 56, 57, 59, 60, 63, 65, 84, 86, 89, 90, 92, 93, 96, 98	DQ0-DQ31	Input/ Output	Data I/Os: Data bus.
49	SA0	Input	Presence-Detect Address Inputs: These pins are used to configure the presence-detect device.

Table 5: Pin Descriptions (Continued)

Pin numbers may not correlate with symbols. Refer to Pin Assignment Tables for pin number and symbol information

PIN NUMBERS	SYMBOL	TYPE	DESCRIPTION
99	SDA	Input/ Output	Serial Presence-Detect Data: SDA is a bidirectional pin used to transfer addresses and data into and out of the presence-detect portion of the module.
100	SCL	Input	Serial Clock for Presence-Detect: SCL is used to synchronize the presence-detect data transfer to and from the module.
5, 8, 14, 19, 30, 38, 41, 55, 58, 64, 69, 80, 88, 91	VDD	Supply	Power Supply: +2.5V \pm 0.2V. Please see note 49, on page 19.
2, 11, 16, 25, 35, 44, 47, 52, 61, 66, 75, 85, 94, 97	VSS	Supply	Ground.
67, 68, 83	DNU	—	Do Not Use: This pin is not connected on these modules, but is an assigned pin on other modules in this product family.
20, 21 (64MB only), 22, 82	NC	—	No Connect: These pins should be left unconnected.



64MB, 128MB (x32)
100-PIN DDR DIMM

Figure 3: Functional Block Diagram

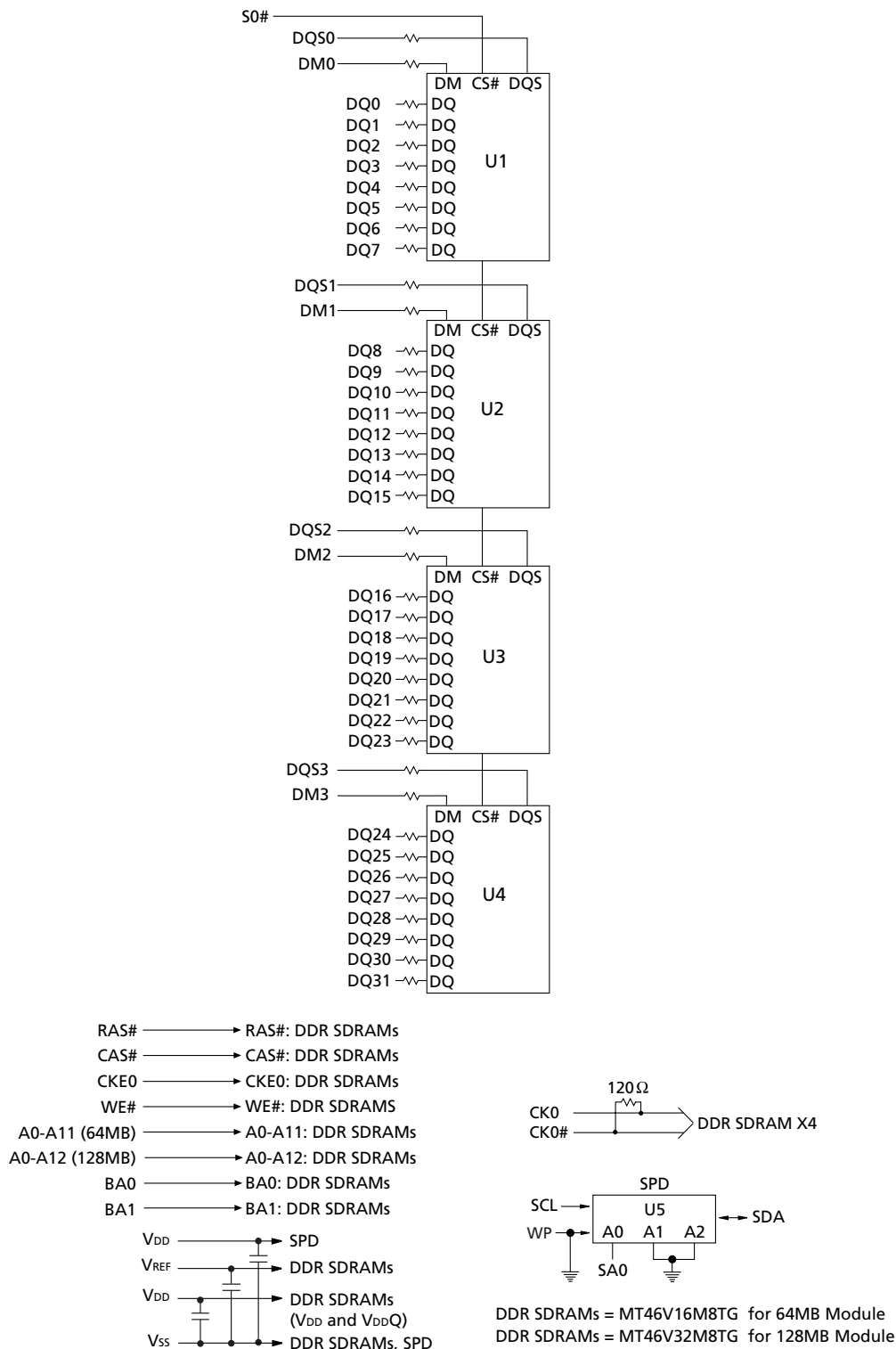

NOTE: All resistor values are 22Ω unless otherwise specified.
 Per industry standard, Micron modules utilize various component speed grades, as referenced in the module part number guide at www.micron.com/numberguide.



General Description

The MT4VDDT1632U and MT4VDDT3232U are high-speed CMOS, dynamic random-access, 64MB and 128MB memory modules organized in x32 configuration. These modules use internally configured quad-bank DDR SDRAMs.

These DDR SDRAM modules use a double data rate architecture to achieve high-speed operation. The double data rate architecture is essentially a $2n$ -prefetch architecture with an interface designed to transfer two data words per clock cycle at the I/O pins. A single read or write access for the DDR SDRAM module effectively consists of a single $2n$ -bit wide, one-clock-cycle data transfer at the internal DRAM core and two corresponding n -bit wide, one-half-clock-cycle data transfers at the I/O pins.

A bidirectional data strobe (DQS) is transmitted externally, along with data, for use in data capture at the receiver. DQS is an intermittent strobe transmitted by the DDR SDRAM during READs and by the memory controller during WRITEs. DQS is edge-aligned with data for READs and center-aligned with data for WRITEs.

These DDR SDRAM modules operate from differential clock inputs (CK and CK#); the crossing of CK going HIGH and CK# going LOW will be referred to as the positive edge of CK. Commands (address and control signals) are registered at every positive edge of CK. Input data is registered on both edges of DQS, and output data is referenced to both edges of DQS, as well as to both edges of CK.

Read and write accesses to the DDR SDRAM modules are burst oriented; accesses start at a selected location and continue for a programmed number of locations in a programmed sequence. Accesses begin with the registration of an ACTIVE command, which is then followed by a READ or WRITE command. The address bits registered coincident with the ACTIVE command are used to select the device bank and row to be accessed (BA0, BA1 select device bank; A0–A11 select device row for 64MB module, A0–A12 select device row for 128MB module). The address bits registered coincident with the READ or WRITE command are used to select the device bank and the starting device column location for the burst access (BA0, BA1; A0–A9).

These DDR SDRAM modules provide for programmable READ or WRITE burst lengths of 2, 4, or 8 locations. An auto precharge function may be enabled to provide a self-timed row precharge that is initiated at the end of the burst access.

The pipelined, multibank architecture of DDR SDRAM modules allows for concurrent operation, thereby providing high effective bandwidth by hiding row precharge and activation time.

An auto refresh mode is provided, along with a power-saving power-down mode. All inputs are compatible with the JEDEC Standard for SSTL_2. All outputs are SSTL_2, Class II compatible. For more information regarding DDR SDRAM operation, refer to the 128Mb and 256Mb DDR SDRAM component data sheets.

Serial Presence-Detect Operation

These DDR SDRAM modules incorporate serial presence-detect (SPD). The SPD function is implemented using a 2,048-bit EEPROM. This nonvolatile storage device contains 256 bytes. The first 128 bytes can be programmed by Micron to identify the module type and various SDRAM organizations and timing parameters. The remaining 128 bytes of storage are available for use by the customer. System READ/WRITE operations between the master (system logic) and the slave EEPROM device (DIMM) occur via a standard IIC bus using the DIMM's SCL (clock) and SDA (data) signals, together with SA (2:0), which provide eight unique DIMM/EEPROM addresses.

Mode Register Definition

The mode register is used to define the specific mode of operation of the DDR SDRAM. This definition includes the selection of a burst length, a burst type, a CAS latency and an operating mode, as shown in Figure 4, Mode Register Definition Diagram, on page 7. The mode register is programmed via the MODE REGISTER SET command (with BA0 = 0 and BA1 = 0) and will retain the stored information until it is programmed again or the device loses power (except for bit A8, which is self-clearing).

Reprogramming the mode register will not alter the contents of the memory, provided it is performed correctly. The mode register must be loaded (reloaded) when all device banks are idle and no bursts are in progress, and the controller must wait the specified time before initiating the subsequent operation. Violating either of these requirements will result in unspecified operation.

Mode register bits A0–A2 specify the burst length, A3 specifies the type of burst (sequential or interleaved), A4–A6 specify the CAS latency, and A7–A11 (64MB module) or A7–A12 (128MB module) specify the operating mode.



Burst Length

Read and write accesses to the DDR SDRAM are burst oriented, with the burst length being programmable, as shown in Mode Register Diagram. The burst length determines the maximum number of column locations that can be accessed for a given READ or WRITE command. Burst lengths of 2, 4, or 8 locations are available for both the sequential and the interleaved burst types.

Reserved states should not be used, as unknown operation or incompatibility with future versions may result.

When a READ or WRITE command is issued, a block of columns equal to the burst length is effectively selected. All accesses for that burst take place within this block, meaning that the burst will wrap within the block if a boundary is reached. The block is uniquely selected by A1–A9 when the burst length is set to two, by A2–A9 when the burst length is set to four and by A3–A9 when the burst length is set to eight. The remaining (least significant) address bit(s) is (are) used to select the starting location within the block. The programmed burst length applies to both READ and WRITE bursts.

Burst Type

Accesses within a given burst may be programmed to be either sequential or interleaved; this is referred to as the burst type and is selected via bit M3.

The ordering of accesses within a burst is determined by the burst length, the burst type and the starting column address, as shown in Table 6, Burst Definition Table, on page 8.

Read Latency

The READ latency is the delay, in clock cycles, between the registration of a READ command and the availability of the first bit of output data. The latency can be set to 2 or 2.5 clocks, as shown in Figure 5, CAS Latency Diagram, on page 8.

If a READ command is registered at clock edge *n*, and the latency is *m* clocks, the data will be available nominally coincident with clock edge *n + m*. Table 7, CAS Latency (CL) Table, on page 8, indicates the operating frequencies at which each CAS latency setting can be used.

Reserved states should not be used as unknown operation or incompatibility with future versions may result.

Figure 4: Mode Register Definition Diagram

64MB Module Address Bus

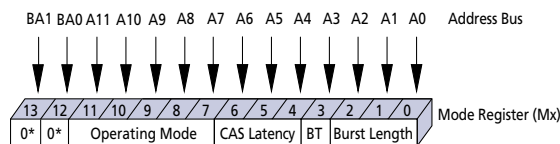

* M13 and M12 (BA1 and BA0) must be "0, 0" to select the base mode register (vs. the extended mode register).

128MB Module Address Bus

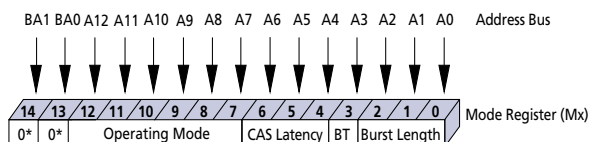

* M14 and M13 (BA1 and BA0) must be "0, 0" to select the base mode register (vs. the extended mode register).

M2 M1 M0			Burst Length	
			M3 = 0	M3 = 1
0	0	0	Reserved	Reserved
0	0	1	2	2
0	1	0	4	4
0	1	1	8	8
1	0	0	Reserved	Reserved
1	0	1	Reserved	Reserved
1	1	0	Reserved	Reserved
1	1	1	Reserved	Reserved

M3	Burst Type
0	Sequential
1	Interleaved

M6	M5	M4	CAS Latency
0	0	0	Reserved
0	0	1	Reserved
0	1	0	2
0	1	1	Reserved
1	0	0	Reserved
1	0	1	Reserved
1	1	0	2.5
1	1	1	Reserved

M12	M11	M10	M9	M8	M7	M6-M0	Operating Mode
0	0	0	0	0	0	Valid	Normal Operation
0	0	0	0	1	0	Valid	Normal Operation/Reset DLL
-	-	-	-	-	-	-	All other states reserved



Table 6: Burst Definition Table

BURST LENGTH	STARTING COLUMN ADDRESS		ORDER OF ACCESSES WITHIN A BURST		
			TYPE = SEQUENTIAL	TYPE = INTERLEAVED	
2	A0				
	0	1	0-1	1-0	
4	A1	A0			
	0	0	0-1-2-3	0-1-2-3	
	0	1	1-2-3-0	1-0-3-2	
	1	0	2-3-0-1	2-3-0-1	
	1	1	3-0-1-2	3-2-1-0	
8	A2	A1	A0		
	0	0	0	0-1-2-3-4-5-6-7	0-1-2-3-4-5-6-7
	0	0	1	1-2-3-4-5-6-7-0	1-0-3-2-5-4-7-6
	0	1	0	2-3-4-5-6-7-0-1	2-3-0-1-6-7-4-5
	0	1	1	3-4-5-6-7-0-1-2	3-2-1-0-7-6-5-4
	1	0	0	4-5-6-7-0-1-2-3	4-5-6-7-0-1-2-3
	1	0	1	5-6-7-0-1-2-3-4	5-4-7-6-1-0-3-2
	1	1	0	6-7-0-1-2-3-4-5	6-7-4-5-2-3-0-1
	1	1	1	7-0-1-2-3-4-5-6	7-6-5-4-3-2-1-0

NOTE:

1. For a burst length of two, A1–A9 select the two data-element block; A0 selects the first access within the block.
2. For a burst length of four, A2–A9 select the four data-element block; A0–A1 select the first access within the block.
3. For a burst length of eight, A3–A9 select the eight data-element block; A0–A2 select the first access within the block.
4. Whenever a boundary of the block is reached within a given sequence above, the following access wraps within the block.

Table 7: CAS Latency (CL) Table

SPEED	ALLOWABLE OPERATING CLOCK FREQUENCY (MHZ)	
	CL = 2	CL = 2.5
-6	N/A	75 ≤ f ≤ 167
-75	75 ≤ f ≤ 100	75 ≤ f ≤ 133

Figure 5: CAS Latency Diagram

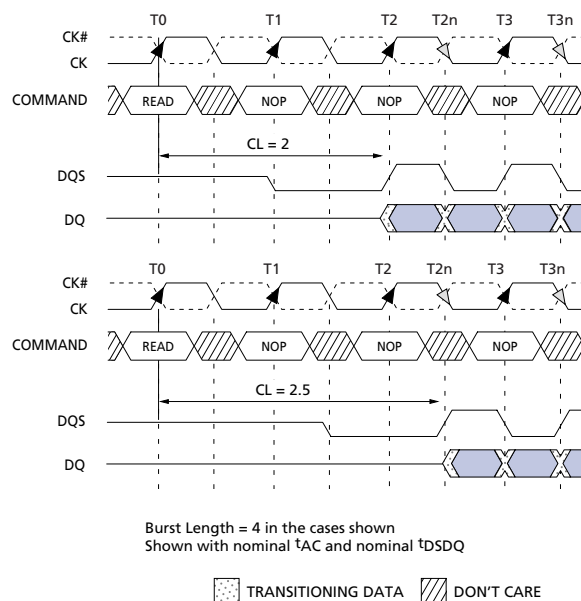

Operating Mode

The normal operating mode is selected by issuing a MODE REGISTER SET command with bits A7–A11 (for 64MB module), or A7–A12 (128MB module) each set to zero, and bits A0–A6 set to the desired values. A DLL reset is initiated by issuing a MODE REGISTER SET command with bits A7 and A9–A11 (for 64MB module), or A7 and A9–A12 (128MB module) each set to zero, bit A8 set to one, and bits A0–A6 set to the desired values. Although not required by the Micron device, JEDEC specifications recommend when a LOAD MODE REGISTER command is issued to reset the DLL, it should always be followed by a LOAD MODE REGISTER command to select normal operating mode.

All other combinations of values for A7–A11, or A7–A12 are reserved for future use and/or test modes. Test modes and reserved states should not be used because unknown operation or incompatibility with future versions may result.



Extended Mode Register

The extended mode register controls functions beyond those controlled by the mode register; these additional functions are DLL enable/disable, output drive strength, and QFC#. These functions are controlled via the bits shown in Figure 6, Extended Mode Register Definition Diagram. The extended mode register is programmed via the LOAD MODE REGISTER command to the mode register (with BA0 = 1 and BA1 = 0) and will retain the stored information until it is programmed again or the device loses power. The enabling of the DLL should always be followed by a LOAD MODE REGISTER command to the mode register (BA0/BA1 both LOW) to reset the DLL.

The extended mode register must be loaded when all device banks are idle and no bursts are in progress, and the controller must wait the specified time before initiating any subsequent operation. Violating either of these requirements could result in unspecified operation.

Output Drive Strength

The normal full drive strength for all outputs is specified to be SSTL2, Class II. For detailed information on output drive strength, refer to 128Mb and 256Mb DDR SDRAM component data sheets.

DLL Enable/Disable

The DLL must be enabled for normal operation. DLL enable is required during power-up initialization and upon returning to normal operation after having disabled the DLL for the purpose of debug or evaluation. (When the device exits self refresh mode, the DLL is enabled automatically.) Any time the DLL is enabled, 200 clock cycles must occur before a READ command can be issued.

Figure 6: Extended Mode Register Definition Diagram

64MB Module

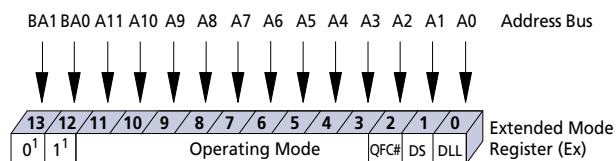

128MB Module

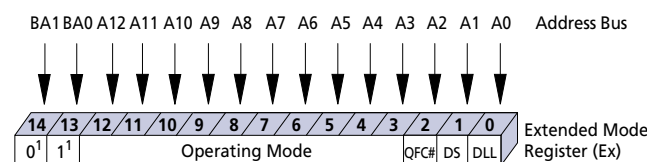

E0	DLL
0	Enable
1	Disable

E1	Drive Strength
0	Normal

E2 ²	QFC Function
0	Disabled
-	Reserved

E11	E10	E9	E8	E7	E6	E5	E4	E3	E2, E1, E0	Operating Mode
0	0	0	0	0	0	0	0	0	Valid	Normal Operation
-	-	-	-	-	-	-	-	-	-	All other states reserved

- Notes:**
1. E13 and E12 (BA1 and BA0) must be "0, 1" to select the Extended Mode Register (vs. the base Mode Register) for 64MB module, or E14 and E13 for 128MB module.
 2. The QFC option is not supported.



Commands

The Truth Tables below provide a general reference of available commands. For a more detailed descrip-

tion of commands and operations, refer to the 128Mb or 256Mb DDR SDRAM component data sheet.

Table 8: Truth Table – Commands

Note: 1

NAME (FUNCTION)	CS#	RAS#	CAS#	WE#	ADDR	NOTES
DESELECT (NOP)	H	X	X	X	X	9
NO OPERATION (NOP)	L	H	H	H	X	9
ACTIVE (Select device bank and activate row)	L	L	H	H	Bank/Row	3
READ (Select device bank and column, and start READ burst)	L	H	L	H	Bank/Col	4
WRITE (Select bank and column, and start WRITE burst)	L	H	L	L	Bank/Col	4
BURST TERMINATE	L	H	H	L	X	8
PRECHARGE (Deactivate row in bank or banks)	L	L	H	L	Code	5
AUTO REFRESH or SELF REFRESH (Enter self refresh mode)	L	L	L	H	X	6, 7
LOAD MODE REGISTER	L	L	L	L	Op-Code	2

Table 9: Truth Table – DM Operation

Note: 10

NAME (FUNCTION)	DM	DQS
WRITE Enable	L	Valid
WRITE Inhibit	H	X

NOTE:

1. CKE is HIGH for all commands shown except SELF REFRESH.
2. BA0–BA1 select either the mode register or the extended mode register (BA0 = 0, BA1 = 0 select the mode register; BA0 = 1, BA1 = 0 select extended mode register; other combinations of BA0–BA1 are reserved). A0–A11 (64MB module) or A0–A12 (128MB module) provide the op-code to be written to the selected mode register.
3. BA0–BA1 provide device bank address and A0–A11 (128MB module) or A0–A12 (256MB module) provide row address.
4. BA0–BA1 provide device bank address; A0–A9 provide column address; A10 HIGH enables the auto precharge feature (nonpersistent), and A10 LOW disables the auto precharge feature.
5. A10 LOW: BA0–BA1 determine which device bank is precharged. A10 HIGH: all device banks are precharged and BA0–BA1 are “Don’t Care.”
6. This command is AUTO REFRESH if CKE is HIGH, SELF REFRESH if CKE is LOW.
7. Internal refresh counter controls row addressing; all inputs and I/Os are “Don’t Care” except for CKE.
8. Applies only to read bursts with auto precharge disabled; this command is undefined (and should not be used) for READ bursts with auto precharge enabled and for WRITE bursts.
9. DESELECT and NOP are functionally interchangeable.
10. Used to mask write data; provided coincident with the corresponding data.



Absolute Maximum Ratings

Stresses greater than those listed may cause permanent damage to the device. This is a stress rating only, and functional operation of the device at these or any other conditions above those indicated in the opera-

Voltage on VDD Supply	
Relative to VSS	-1V to +3.6V
Voltage on VDDQ Supply	
Relative to VSS	-1V to +3.6V
Voltage on VREF and Inputs	
Relative to VSS	-1V to +3.6V
Voltage on I/O Pins	
Relative to VSS	-0.5V to VDDQ +0.5V

tional sections of this specification is not implied. Exposure to absolute maximum rating conditions for extended periods may affect reliability.

Operating Temperature,	
TA (ambient)	0°C to +70°C
Storage Temperature (plastic)	-55°C to +150°C
Power Dissipation	4W
Short Circuit Output Current	50mA

Table 10: DC Electrical Characteristics and Operating Conditions

Notes: 1–5, 14, 49; notes appear on pages 16–19; $0^{\circ}\text{C} \leq T_A \leq +70^{\circ}\text{C}$

PARAMETER/CONDITION	SYMBOL	MIN	MAX	UNITS	NOTES
Supply Voltage	VDD	2.3	2.7	V	32, 36
I/O Supply Voltage	VDDQ	2.3	2.7	V	32, 36, 39
I/O Reference Voltage	VREF	$0.49 \times V_{DDQ}$	$0.51 \times V_{DDQ}$	V	6, 39
I/O Termination Voltage (system)	VTT	$V_{REF} - 0.04$	$V_{REF} + 0.04$	V	7, 39
Input High (Logic 1) Voltage	V _{IH} (DC)	$V_{REF} + 0.15$	$V_{DD} + 0.3$	V	25
Input Low (Logic 0) Voltage	V _{IL} (DC)	-0.3	$V_{REF} - 0.15$	V	25
INPUT LEAKAGE CURRENT Any input $0V \leq V_{IN} \leq V_{DD}$, VREF pin $0V \leq V_{IN} \leq 1.35V$ (All other pins not under test = 0V)	Command/ Address, RAS#, CAS#, WE#, CKE, S#, CK, CK#	-8	8	μA	48
	DM	-2	2	μA	
OUTPUT LEAKAGE CURRENT (DQs are disabled; $0V \leq V_{OUT} \leq V_{DDQ}$)	DQ, DQS	-5	5	μA	48
OUTPUT LEVELS					
High Current ($V_{OUT} = V_{DDQ} - 0.373V$, minimum VREF, minimum VTT)	I _{OH}	-16.8	–	mA	33, 34
Low Current ($V_{OUT} = 0.373V$, maximum VREF, maximum VTT)	I _{OL}	16.8	–	mA	

Table 11: AC Input Operating Conditions

Notes: 1–5, 14, 49; notes appear on pages 16–19; $0^{\circ}\text{C} \leq T_A \leq +70^{\circ}\text{C}$; $V_{DD} = V_{DDQ} = +2.5V \pm 0.2V$

PARAMETER/CONDITION	SYMBOL	MIN	MAX	UNITS	NOTES
Input High (Logic 1) Voltage	V _{IH} (AC)	$V_{REF} + 0.310$	–	V	12, 25, 35
Input Low (Logic 0) Voltage	V _{IL} (AC)	–	$V_{REF} - 0.310$	V	12, 25, 35
I/O Reference Voltage	VREF (AC)	$0.49 \times V_{DDQ}$	$0.51 \times V_{DDQ}$	V	6

Table 12: IDD Specifications and Conditions – 64MB Module

DDR SDRAM components only

 Notes: 1–5, 14, 49; notes appear on pages 16–19; $0^{\circ}\text{C} \leq T_A \leq +70^{\circ}\text{C}$; $V_{DD} = V_{DDQ} = +2.5\text{V} \pm 0.2\text{V}$

PARAMETER/CONDITION	SYMBOL	MAX		UNITS	NOTES
		-6	-75		
OPERATING CURRENT: One device bank; Active-Precharge; $t_{RC} = t_{RC}(\text{MIN})$; $t_{CK} = t_{CK}(\text{MIN})$; DQ, DM and DQS inputs changing once per clock cycle; Address and control inputs changing once every two clock cycles	IDD0	TBD	420	mA	20, 43
OPERATING CURRENT: One device bank; Active -Read Precharge; Burst = 2; $t_{RC} = t_{RC}(\text{MIN})$; $t_{CK} = t_{CK}(\text{MIN})$; $I_{OUT} = 0\text{mA}$; Address and control inputs changing once per clock cycle	IDD1	TBD	480	mA	20, 43
PRECHARGE POWER-DOWN STANDBY CURRENT: All device banks idle; Power-down mode; $t_{CK} = t_{CK}(\text{MIN})$; CKE = (LOW)	IDD2P	TBD	12	mA	21, 28, 45
IDLE STANDBY CURRENT: CS# = HIGH; All device banks idle; $t_{CK} = t_{CK}(\text{MIN})$; CKE = HIGH; Address and other control inputs changing once per clock cycle. $V_{IN} = V_{REF}$ for DQ, DQS, and DM	IDD2F	TBD	180	mA	46
ACTIVE POWER-DOWN STANDBY CURRENT: One device bank active; Power-down mode; $t_{CK} = t_{CK}(\text{MIN})$; CKE = LOW	IDD3P	TBD	80	mA	21, 28, 45
ACTIVE STANDBY CURRENT: CS# = HIGH; CKE = HIGH; One device bank; Active-Precharge; $t_{RC} = t_{RAS}(\text{MAX})$; $t_{CK} = t_{CK}(\text{MIN})$; DQ, DM and DQS inputs changing twice per clock cycle; Address and other control inputs changing once per clock cycle	IDD3N	TBD	180	mA	42
OPERATING CURRENT: Burst = 2; Reads; Continuous burst; One device bank active; Address and control inputs changing once per clock cycle; $t_{CK} = t_{CK}(\text{MIN})$; $I_{OUT} = 0\text{mA}$	IDD4R	TBD	500	mA	20, 43
OPERATING CURRENT: Burst = 2; Writes; Continuous burst; One device bank active; Address and control inputs changing once per clock cycle; $t_{CK} = t_{CK}(\text{MIN})$; DQ, DM, and DQS inputs changing twice per clock cycle	IDD4W ^a	TBD	460	mA	20
AUTO REFRESH CURRENT	$t_{RC} = t_{RC}(\text{MIN})$	IDD5	840	mA	20, 45
	$t_{RC} = 15.625\mu\text{s}$	IDD5A	20	mA	24, 45
SELF REFRESH CURRENT: CKE $\leq 0.2\text{V}$	IDD6	TBD	8	mA	9
OPERATING CURRENT: Four device bank interleaving READs (BL = 4) with auto precharge, $t_{RC} = t_{RC}(\text{MIN})$; $t_{CK} = t_{CK}(\text{MIN})$; Address and control inputs change only during Active READ or WRITE commands	IDD7	TBD	1,300	mA	20, 44

Table 13: IDD Specifications and Conditions – 128MB Module

DDR SDRAM components only

 Notes: 1–5, 14, 49; notes appear on pages 16–19; $0^{\circ}\text{C} \leq T_A \leq +70^{\circ}\text{C}$; $V_{DD} = V_{DDQ} = +2.5\text{V} \pm 0.2\text{V}$

PARAMETER/CONDITION	SYMBOL	MAX		UNITS	NOTES	
		-6	-75			
OPERATING CURRENT: One device bank; Active-Precharge; $t_{RC} = t_{RC}(\text{MIN})$; $t_{CK} = t_{CK}(\text{MIN})$; DQ, DM and DQS inputs changing once per clock cycle; Address and control inputs changing once every two clock cycles	IDD0	TBD	480	mA	20, 43	
OPERATING CURRENT: One device bank; Active -Read Precharge; Burst = 2; $t_{RC} = t_{RC}(\text{MIN})$; $t_{CK} = t_{CK}(\text{MIN})$; $I_{OUT} = 0\text{mA}$; Address and control inputs changing once per clock cycle	IDD1	TBD	560	mA	20, 43	
PRECHARGE POWER-DOWN STANDBY CURRENT: All device banks idle; Power-down mode; $t_{CK} = t_{CK}(\text{MIN})$; CKE = (LOW)	IDD2P	TBD	16	mA	21, 28, 45	
IDLE STANDBY CURRENT: CS# = HIGH; All device banks idle; $t_{CK} = t_{CK}(\text{MIN})$; CKE = HIGH; Address and other control inputs changing once per clock cycle. $V_{IN} = V_{REF}$ for DQ, DQS, and DM	IDD2F	TBD	160	mA	46	
ACTIVE POWER-DOWN STANDBY CURRENT: One device bank active; Power-down mode; $t_{CK} = t_{CK}(\text{MIN})$; CKE = LOW	IDD3P	TBD	120	mA	21, 28, 45	
ACTIVE STANDBY CURRENT: CS# = HIGH; CKE = HIGH; One device bank; Active-Precharge; $t_{RC} = t_{RAS}(\text{MAX})$; $t_{CK} = t_{CK}(\text{MIN})$; DQ, DM and DQS inputs changing twice per clock cycle; Address and other control inputs changing once per clock cycle	IDD3N	TBD	180	mA	42	
OPERATING CURRENT: Burst = 2; Reads; Continuous burst; One device bank active; Address and control inputs changing once per clock cycle; $t_{CK} = t_{CK}(\text{MIN})$; $I_{OUT} = 0\text{mA}$	IDD4R	TBD	700	mA	20, 43	
OPERATING CURRENT: Burst = 2; Writes; Continuous burst; One device bank active; Address and control inputs changing once per clock cycle; $t_{CK} = t_{CK}(\text{MIN})$; DQ, DM, and DQS inputs changing twice per clock cycle	IDD4W	TBD	760	mA	20	
AUTO REFRESH CURRENT	$t_{RC} = t_{RC}(\text{MIN})$	IDD5	TBD	980	mA	20, 45
	$t_{RC} = 7.8125\mu\text{s}$	IDD5A	TBD	24	mA	24, 45
SELF REFRESH CURRENT: CKE $\leq 0.2\text{V}$	IDD6	TBD	16	mA	9	
OPERATING CURRENT: Four device bank interleaving READs (BL = 4) with auto precharge, $t_{RC} = t_{RC}(\text{MIN})$; $t_{CK} = t_{CK}(\text{MIN})$; Address and control inputs change only during Active READ or WRITE commands	IDD7	TBD	1,460	mA	20, 44	

Table 14: Capacitance (All Modules)

Note: 11; notes appear following parameter tables.

PARAMETER	SYMBOL	MIN	MAX	UNITS
Input/Output Capacitance: DQ, DQS, DM	C _{IO}	4	5	pF
Input Capacitance: Command and Address, S0#, CK0, CK0#, CKE0	C _{I1}	8	12	pF

Table 15: DDR SDRAM Component Electrical Characteristics and Recommended AC Operating Conditions

 Notes: 1–5, 12–15, 29, 49; notes appear on pages 16–19; 0°C ≤ T_A ≤ +70°C; V_{DD} = V_{DDQ} = +2.5V ±0.2V

AC CHARACTERISTICS		-6		-75			
PARAMETER	SYMBOL	MIN	MAX	MIN	MAX	UNITS	NOTES
Access window of DQ from CK/CK#	t _{AC}	-0.7	+0.7	-0.75	+0.75	ns	
CK high-level width	t _{CH}	0.45	0.55	0.45	0.55	t _{CK}	26
CK low-level width	t _{CL}	0.45	0.55	0.45	0.55	t _{CK}	26
Clock cycle time	CL=2.5 t _{CK} (2.5)	6	13	7.5	13	ns	40, 47
	CL=2 t _{CK} (2)	7.5	13	10	13	ns	40, 47
DQ and DM input hold time relative to DQS	t _{DH}	0.45		0.5		ns	23, 27
DQ and DM input setup time relative to DQS	t _{DS}	0.45		0.5		ns	23, 27
DQ and DM input pulse width (for each input)	t _{DIPW}	1.75		1.75		ns	27
Access window of DQS from CK/CK#	t _{DQSCK}	-0.6	+0.6	-0.75	+0.75	ns	
DQS input high pulse width	t _{DQSH}	0.35		0.35		t _{CK}	
DQS input low pulse width	t _{DQSL}	0.35		0.35		t _{CK}	
DQS-DQ skew, DQS to last DQ valid, per group, per access	t _{DQSQ}		0.45		0.5	ns	22, 23
Write command to first DQS latching transition	t _{DQSS}	0.75	1.25	0.75	1.25	t _{CK}	
DQS falling edge to CK rising - setup time	t _{DSS}	0.2		0.2		t _{CK}	
DQS falling edge from CK rising - hold time	t _{DSH}	0.2		0.2		t _{CK}	
Half clock period	t _{HP}	t _{CH} , t _{CL}		t _{CH} , t _{CL}		ns	30
Data-out high-impedance window from CK/CK#	t _{HZ}		+0.70		+0.75	ns	16, 37
Data-out low-impedance window from CK/CK#	t _{LZ}	-0.7		-0.75		ns	16, 38
Address and control input hold time (fast slew rate)	t _{IHF}	0.75		.90		ns	12
Address and control input setup time (fast slew rate)	t _{ISF}	0.75		.90		ns	12
Address and control input hold time (slow slew rate)	t _{IHS}	0.8		1		ns	12
Address and control input setup time (slow slew rate)	t _{ISs}	0.8		1		ns	12
LOAD MODE REGISTER command cycle time	t _{MRD}	12		15		ns	
DQ-DQS hold, DQS to first DQ to go non-valid, per access	t _{QH}	t _{HP} - t _{QHS}		t _{HP} - t _{QHS}		ns	22, 23
Data hold skew factor	t _{QHS}		0.6		0.75	ns	
ACTIVE to PRECHARGE command	t _{RAS}	42	70,000	40	120,000	ns	31

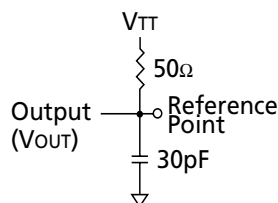

Table 15: DDR SDRAM Component Electrical Characteristics and Recommended AC Operating Conditions (Continued)

 Notes: 1–5, 12–15, 29, 49; notes appear on pages 16–19; $0^{\circ}\text{C} \leq T_A \leq +70^{\circ}\text{C}$; $V_{DD} = V_{DDQ} = +2.5\text{V} \pm 0.2\text{V}$

AC CHARACTERISTICS			-6		-75			
PARAMETER		SYMBOL	MIN	MAX	MIN	MAX	UNITS	NOTES
ACTIVE to READ with Auto precharge command	64MB	t_{RAP}	18		$t_{RAS}(\text{MIN}) - \text{burst length} * t_{CK}/2$		ns	41
ACTIVE to READ with Auto precharge command	128MB	t_{RAP}	18		20		ns	41
ACTIVE to ACTIVE/AUTO REFRESH command period		t_{RC}	60		65		ns	
AUTO REFRESH command period		t_{RFC}	72		75		ns	45
ACTIVE to READ or WRITE delay		t_{RCD}	18		20		ns	
PRECHARGE command period		t_{RP}	18		20		ns	
DQS read preamble		t_{RPRE}	0.9	1.1	0.9	1.1	t_{CK}	37
DQS read postamble		t_{RPST}	0.4	0.6	0.4	0.6	t_{CK}	
ACTIVE bank a to ACTIVE bank b command		t_{RRD}	12		15		ns	
DQS write preamble		t_{WPRE}	0.25		0.25		t_{CK}	
DQS write preamble setup time		t_{WPRES}	0		0		ns	18, 19
DQS write postamble		t_{WPST}	0.4	0.6	0.4	0.6	t_{CK}	17
Write recovery time		t_{WR}	15		15		ns	
Internal WRITE to READ command delay		t_{WTR}	1		1		t_{CK}	
Data valid output window		na	$t_{QH} - t_{DQSQ}$		$t_{QH} - t_{DQSQ}$		ns	22
REFRESH to REFRESH command interval	64MB	t_{REFC}		140		140.6	μs	21
REFRESH to REFRESH command interval	128MB	t_{REFC}		70.3		70.3	μs	21
Average periodic refresh interval	64MB	t_{REFI}		15.6		15.6	μs	21
Average periodic refresh interval	128MB	t_{REFI}		7.8		7.8	μs	21
Terminating voltage delay to V_{DD}		t_{VTD}	0		0		ns	
Exit SELF REFRESH to non-READ command		t_{XSNR}	75		75		ns	
Exit SELF REFRESH to READ command		t_{XSRD}	200		200		t_{CK}	

Notes

1. All voltages referenced to VSS.
2. Tests for AC timing, I_{DD}, and electrical AC and DC characteristics may be conducted at nominal reference/supply voltage levels, but the related specifications and device operation are guaranteed for the full voltage range specified.
3. Outputs measured with equivalent load:

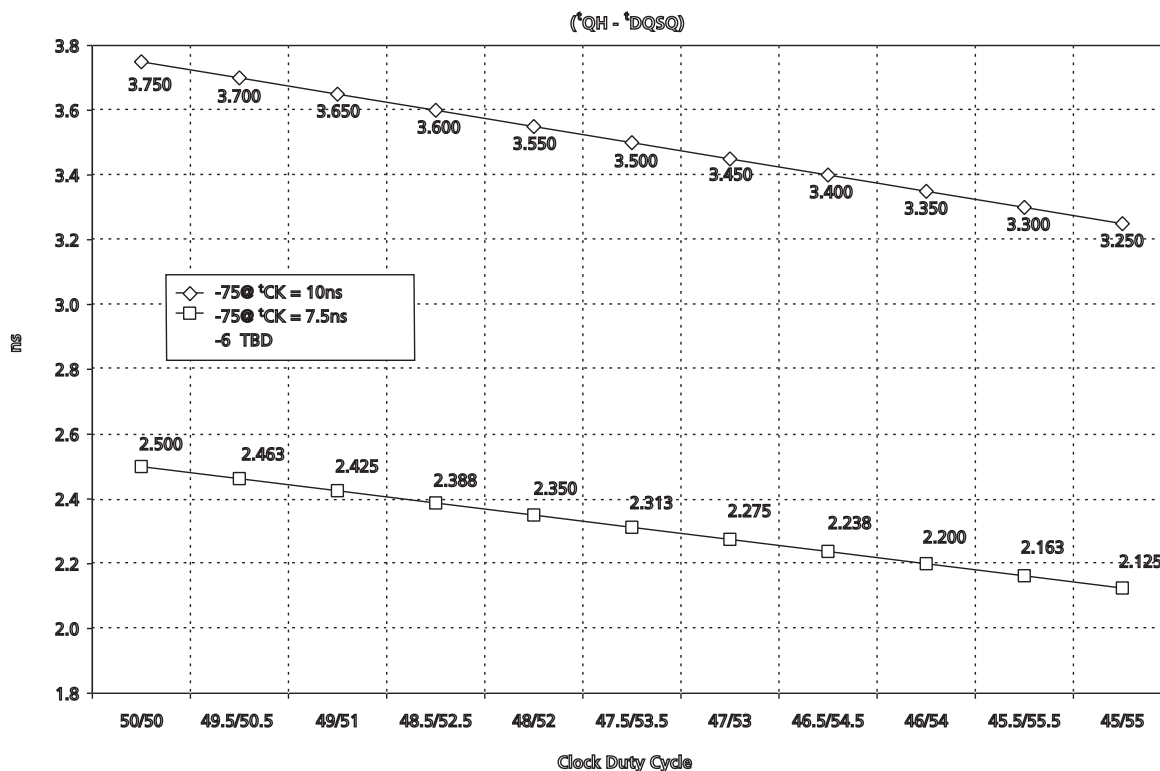

4. AC timing and I_{DD} tests may use a V_{IL}-to-V_{IH} swing of up to 1.5V in the test environment, but input timing is still referenced to V_{REF} (or to the crossing point for CK/CK#), and parameter specifications are guaranteed for the specified AC input levels under normal use conditions. The minimum slew rate for the input signals used to test the device is 1V/ns in the range between V_{IL} (AC) and V_{IH} (AC).
5. The AC and DC input level specifications are as defined in the SSTL_2 Standard (i.e., the receiver will effectively switch as a result of the signal crossing the AC input level, and will remain in that state as long as the signal does not ring back above [below] the DC input LOW [HIGH] level).
6. V_{REF} is expected to equal V_{DDQ}/2 of the transmitting device and to track variations in the DC level of the same. Peak-to-peak noise (non-common mode) on V_{REF} may not exceed ±2 percent of the DC value. Thus, from V_{DDQ}/2, V_{REF} is allowed ±25mV for DC error and an additional ±25mV for AC noise. This measurement is to be taken at the nearest V_{REF} bypass capacitor.
7. V_{TT} is not applied directly to the device. V_{TT} is a system supply for signal termination resistors, is expected to be set equal to V_{REF} and must track variations in the DC level of V_{REF}.
8. I_{DD} is dependent on output loading and cycle rates. Specified values are obtained with minimum cycle time at CL = 2.5 for -6 and -75 with the outputs open.
9. Enables on-chip refresh and address counters.
10. I_{DD} specifications are tested after the device is properly initialized, and is averaged at the defined cycle rate.
11. This parameter is sampled. V_{DD} = +2.5V ±0.2V, V_{DDQ} = +2.5V ±0.2V, V_{REF} = V_{SS}, f = 100 MHz, T_A = 25°C, V_{OUT} (DC) = V_{DDQ}/2, V_{OUT} (peak to peak) = 0.2V. DM input is grouped with I/O pins, reflecting the fact that they are matched in loading.
12. Command/Address input slew rate = 0.5V/ns. For -75 with slew rates 1V/ns and faster, t_{IS} and t_{IH} are reduced to 900ps. If the slew rate is less than 0.5V/ns, timing must be derated: t_{IS} has an additional 50ps per each 100mV/ns reduction in slew rate from the 500mV/ns. t_{IH} has 0ps added, that is, it remains constant. If the slew rate exceeds 4.5V/ns, functionality is uncertain.
13. The CK/CK# input reference level (for timing referenced to CK/CK#) is the point at which CK and CK# cross; the input reference level for signals other than CK/CK# is V_{REF}.
14. Inputs are not recognized as valid until V_{REF} stabilizes. Exception: during the period before V_{REF} stabilizes, CKE ≤ 0.3 x V_{DDQ} is recognized as LOW.
15. The output timing reference level, as measured at the timing reference point indicated in Note 3, is V_{TT}.
16. t_{HZ} and t_{LZ} transitions occur in the same access time windows as valid data transitions. These parameters are not referenced to a specific voltage level, but specify when the device output is no longer driving (HZ) or begins driving (LZ).
17. The maximum limit for this parameter is not a device limit. The device will operate with a greater value for this parameter, but system performance (bus turnaround) will degrade accordingly.
18. This is not a device limit. The device will operate with a negative value, but system performance could be degraded due to bus turnaround.
19. It is recommended that DQS be valid (HIGH or LOW) on or before the WRITE command. The case shown (DQS going from High-Z to logic LOW) applies when no WRITES were previously in progress on the bus. If a previous WRITE was in progress, DQS could be HIGH during this time, depending on t_{DQSS}.
20. MIN (t_{RC} or t_{RFC}) for I_{DD} measurements is the smallest multiple of t_{CK} that meets the minimum absolute value for the respective parameter. t_{RAS} (MAX) for I_{DD} measurements is the largest multiple of t_{CK} that meets the maximum absolute value for t_{RAS}.

Figure 7: Derating Data Valid Window

21. The refresh period 64ms. This equates to an average refresh rate of 15.625 μ s (64MB module) or 7.8125 μ s (128MB module). However, an AUTO REFRESH command must be asserted at least once every 140.6 μ s (64MB module) or 70.3 μ s (128MB module); burst refreshing or posting by the DRAM controller greater than eight refresh cycles is not allowed.
22. The valid data window is derived by achieving other specifications - t_{HP} ($t_{CK}/2$), t_{DQSQ} , and t_{QH} ($t_{QH} = t_{HP} - t_{QHS}$). The data valid window derates directly proportional with the clock duty cycle and a practical data valid window can be derived. The clock is allowed a maximum duty cycle variation of 45/55. Functionality is uncertain when operating beyond a 45/55 ratio. The data valid window derating curves are provided below for duty cycles ranging between 50/50 and 45/55.
23. Referenced to each output group: x8 = DQ0-DQ7.
24. This limit is actually a nominal value and does not result in a fail value. CKE is HIGH during REFRESH command period (t_{RFC} [MIN]) else CKE is LOW (i.e., during standby).
25. To maintain a valid level, the transitioning edge of the input must:
 - a. Sustain a constant slew rate from the current AC level through to the target AC level, V_{IL} (AC) or V_{IH} (AC).
 - b. Reach at least the target AC level.
 - c. After the AC target level is reached, continue to maintain at least the target DC level, V_{IL} (DC) or V_{IH} (DC).
26. JEDEC specifies CK and CK# input slew rate must be $\geq 1V/ns$ (2V/ns differentially).
27. DQ and DM input slew rates must not deviate from DQS by more than 10 percent. If the DQ/DM/DQS slew rate is less than 0.5V/ns, timing must be derated: 50ps must be added to t_{DS} and t_{DH} for each 100mv/ns reduction in slew rate. If slew rate exceeds 4V/ns, functionality is uncertain.
28. VDD must not vary more than 4 percent if CKE is not active while any bank is active.
29. The clock is allowed up to $\pm 150ps$ of jitter. Each timing parameter is allowed to vary by the same amount.
30. t_{HP} min is the lesser of t_{CL} minimum and t_{CH} minimum actually applied to the device CK and CK/ inputs, collectively during bank active.

31. READs and WRITEs with auto precharge are not allowed to be issued until t^{RAS} (MIN) can be satisfied prior to the internal precharge command being issued.
32. Any positive glitch to the nominal voltage must be less than 1/3 of the clock and not more than +400mV or 2.9 volts maximum, whichever is less. Any negative glitch must be less than 1/3 of the clock cycle and not exceed either -300mV or 2.2 volts minimum, whichever is more positive.
33. Normal Output Drive Curves:
 - a. The full variation in driver pull-down current from minimum to maximum process, temperature and voltage will lie within the outer bounding lines of the V-I curve of Figure 8, Pull-Down Characteristics.
 - b. The variation in driver pull-down current within nominal limits of voltage and temperature is expected, but not guaranteed, to lie within the inner bounding lines of the V-I curve of Figure 8, Pull-Down Characteristics.
 - c. The full variation in driver pull-up current from minimum to maximum process, temperature and voltage will lie within the outer bounding lines of the V-I curve of Figure 9, Pull-Up Characteristics.
 - d. The variation in driver pull-up current within nominal limits of voltage and temperature is expected, but not guaranteed, to lie within the inner bounding lines of the V-I curve of Figure 9, Pull-Up Characteristics.
 - e. The full variation in the ratio of the maximum to minimum pull-up and pull-down current should be between 0.71 and 1.4, for device drain-to-source voltages from 0.1V to 1.0V, and at the same voltage and temperature.
 - f. The full variation in the ratio of the nominal pull-up to pull-down current should be unity ± 10 percent, for device drain-to-source voltages from 0.1V to 1.0V.
34. The voltage levels used are derived from a minimum V_{DD} level and the referenced test load. In practice, the voltage levels obtained from a properly terminated bus will provide significantly different voltage values.
35. V_{IH} overshoot: V_{IH} (MAX) = $V_{\text{DDQ}} + 1.5\text{V}$ for a pulse width $\leq 3\text{ns}$ and the pulse width can not be greater than 1/3 of the cycle rate. V_{IL} undershoot: V_{IL} (MIN) = -1.5V for a pulse width $\leq 3\text{ns}$ and the pulse width can not be greater than 1/3 of the cycle rate.
36. V_{DD} and V_{DDQ} must track each other.
37. This maximum value is derived from the referenced test load. In practice, the values obtained in a typical terminated design may reflect up to 310ps less for t^{HZ} (MAX) and the last DVW. t^{HZ} (MAX) will prevail over t^{DQSCK} (MAX) + t^{RPST} (MAX) condition. t^{LZ} (MIN) will prevail over t^{DQSCK} (MIN) + t^{RPRE} (MAX) condition.
38. For slew rates greater than 1V/ns the (LZ) transition will start about 310ps earlier.
39. During initialization, V_{DDQ} , V_{TT} , and V_{REF} must be equal to or less than $V_{\text{DD}} + 0.3\text{V}$. Alternatively, V_{TT} may be 1.35V maximum during power up, even if $V_{\text{DD}}/V_{\text{DDQ}}$ are 0 volts, provided a minimum of 42 ohms of series resistance is used between the V_{TT} supply and the input pin.
40. The current Micron part operates below the slowest JEDEC operating frequency of 83 MHz. As such, future die may not reflect this option.
41. $t^{\text{RAP}} \geq t^{\text{RCD}}$.
42. For the -6 and -75 IDD3N is specified to be 35mA at 100 MHz.

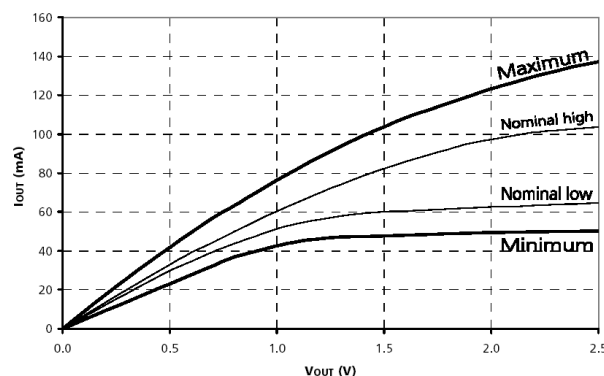
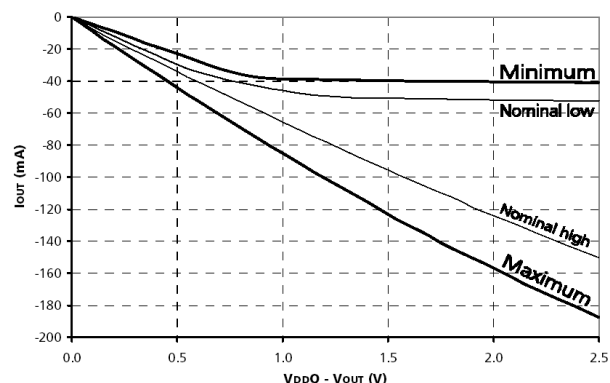
Figure 8: Pull-Down Characteristics

Figure 9: Pull-Up Characteristics



43. Random addressing changing and 50 percent of data changing at every transfer.
44. Random addressing changing and 100 percent of data at every transfer.
45. CKE must be active (high) during the entire time a refresh command is executed. That is, from the time the AUTO REFRESH command is registered, CKE must be active at each rising clock edge, until t_{REF} later.
46. IDD2N specifies the DQ, DQS, and DM to be driven to a valid high or low logic level. IDD2Q is similar to IDD2F except IDD2Q specifies the address and control inputs to remain stable. Although IDD2F, IDD2N, and IDD2Q are similar, IDD2F is “worst case.”
47. Whenever the operating frequency is altered, not including jitter, the DLL is required to be reset. This is followed by 200 clock cycles.
48. Leakage number reflects the worst case leakage possible through the module pin, not what each memory device contributes.
49. The -6 module speed grade, using the -6R speed device, has $V_{DD} (MIN) = 2.4V$.

SPD Clock and Data Conventions

Data states on the SDA line can change only during SCL LOW. SDA state changes during SCL HIGH are reserved for indicating start and stop conditions (as shown in Figure 10, Data Validity and Figure 11, Definition of Start and Stop).

SPD Start Condition

All commands are preceded by the start condition, which is a HIGH-to-LOW transition of SDA when SCL is HIGH. The SPD device continuously monitors the SDA and SCL lines for the start condition and will not respond to any command until this condition has been met.

SPD Stop Condition

All communications are terminated by a stop condition, which is a LOW-to-HIGH transition of SDA when SCL is HIGH. The stop condition is also used to place the SPD device into standby power mode.

SPD Acknowledge

Acknowledge is a software convention used to indicate successful data transfers. The transmitting device, either master or slave, will release the bus after transmitting eight bits. During the ninth clock cycle, the receiver will pull the SDA line LOW to acknowledge that it received the eight bits of data (as shown in Figure 12, Acknowledge Response From Receiver).

The SPD device will always respond with an acknowledge after recognition of a start condition and its slave address. If both the device and a WRITE operation have been selected, the SPD device will respond with an acknowledge after the receipt of each subsequent eight-bit word. In the read mode the SPD device will transmit eight bits of data, release the SDA line and monitor the line for an acknowledge. If an acknowledge is detected and no stop condition is generated by the master, the slave will continue to transmit data. If an acknowledge is not detected, the slave will terminate further data transmissions and await the stop condition to return to standby power mode.

Figure 10: Data Validity

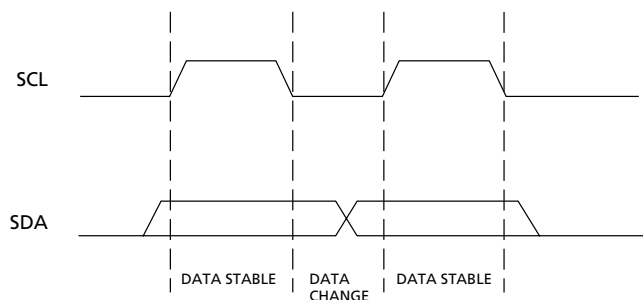

Figure 11: Definition of Start and Stop

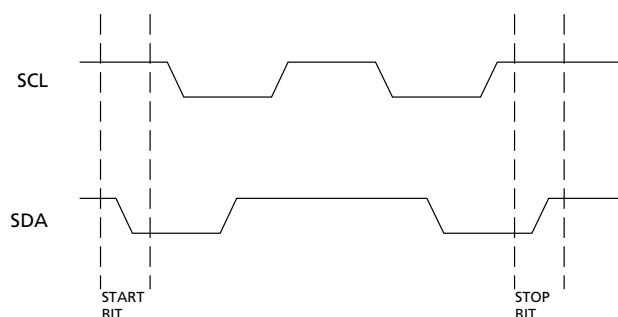

Figure 12: Acknowledge Response From Receiver

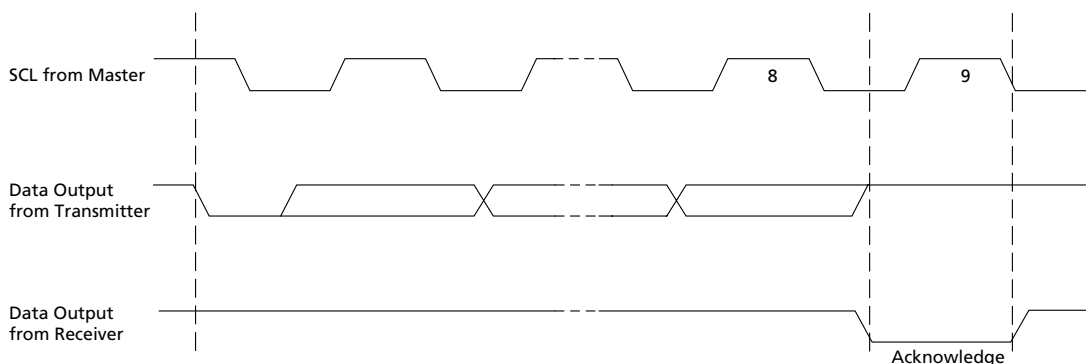



Table 16: EEPROM Device Select Code

The most significant bit (b7) is sent first

	DEVICE TYPE IDENTIFIER				CHIP ENABLE			$\overline{R\overline{W}}$
	b7	b6	b5	b4	b3	b2	b1	b0
Memory Area Select Code (two arrays)	1	0	1	0	SA2	SA1	SA0	$\overline{R\overline{W}}$
Protection Register Select Code	0	1	1	0	SA2	SA1	SA0	$\overline{R\overline{W}}$

Table 17: EEPROM Operating Modes

MODE	$\overline{R\overline{W}}$ BIT	$\overline{W\overline{C}}$	BYTES	INITIAL SEQUENCE
Current Address Read	1	V_{IH} or V_{IL}	1	START, Device Select, $\overline{R\overline{W}} = '1'$
Random Address Read	0	V_{IH} or V_{IL}	1	START, Device Select, $\overline{R\overline{W}} = '0'$, Address
	1	V_{IH} or V_I	1	reSTART, Device Select, $\overline{R\overline{W}} = '1'$
Sequential Read	1	V_{IH} or V_I	≥ 1	Similar to Current or Random Address Read
Byte Write	0	V_{IL}	1	START, Device Select, $\overline{R\overline{W}} = '0'$
Page Write	0	V_{IL}	≤ 16	START, Device Select, $\overline{R\overline{W}} = '0'$

Table 18: Serial Presence-Detect EEPROM DC Operating Conditions
 $V_{DD} = +2.5V \pm 0.2V$

PARAMETER/CONDITION	SYMBOL	MIN	MAX	UNITS
SUPPLY VOLTAGE	V_{DD}	2.3	2.7	V
INPUT HIGH VOLTAGE: Logic 1; All inputs	V_{IH}	$V_{DD} \times 0.7$	$V_{DD} + 1$	V
INPUT LOW VOLTAGE: Logic 0; All inputs	V_{IL}	-0.3	$V_{DD} \times 0.3$	V
OUTPUT LOW VOLTAGE: $I_{OUT} = 3mA$	V_{OL}	-	0.4	V
INPUT LEAKAGE CURRENT: $V_{IN} = GND$ to V_{DD}	I_{LI}	-	± 2	μA
OUTPUT LEAKAGE CURRENT: $V_{OUT} = GND$ to V_{DD}	I_{LO}	-	± 2	μA
SUPPLY CURRENT: $V_{DD} = 2.5 V$, $f_c = 400KHz$ (rise/fall time < 30ns)	I_{CC}	-	1	mA
STAND-BY SUPPLY CURRENT: $V_{IN} = V_{SS}$ or V_{DD} , $V_{DD} = 2.5 V$	I_{SB}	-	0.5	μA

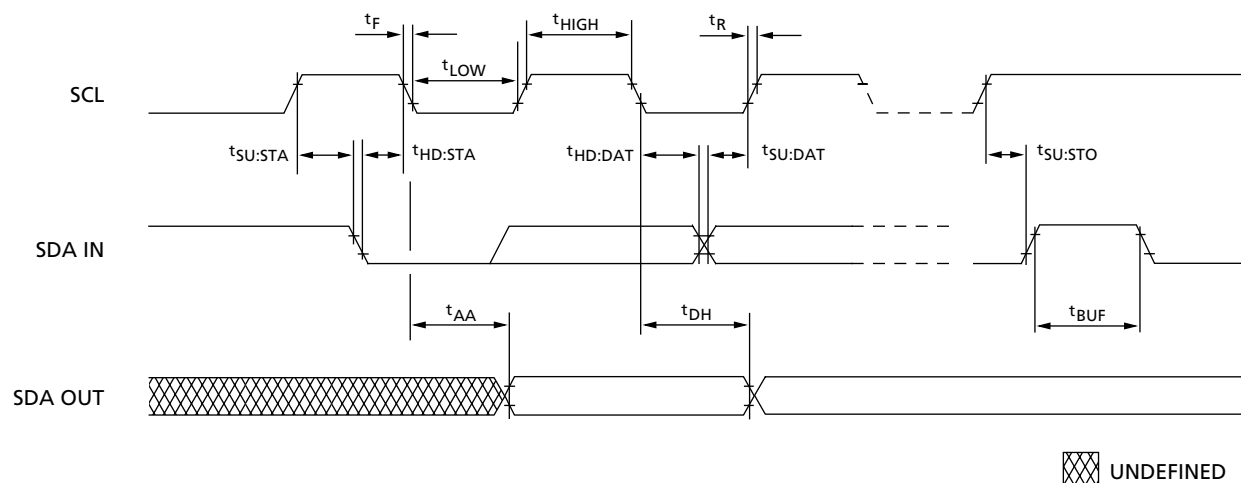
Figure 13: SPD EEPROM Timing Diagram

UNDEFINED

Table 19: Serial Presence-Detect EEPROM AC Operating Conditions

 All voltages referenced to V_{SS} ; $V_{DD} = +2.5V \pm 0.2V$

PARAMETER/CONDITION	SYMBOL	MIN	MAX	UNITS	NOTES
SCL LOW to SDA data-out valid	t_{AA}	200	900	ns	3
Time the bus must be free before a new transition can start	t_{BUF}	1.3		μs	
Data-out hold time	t_{DH}	200		ns	
SDA and SCL fall time	t_F		300	ns	2
Data-in hold time	$t_{HD:DAT}$	0		μs	
Start condition hold time	$t_{HD:STA}$	600		ns	
Clock HIGH period	t_{HIGH}	600		ns	
Clock LOW period	t_{LOW}	1.3		μs	
SDA and SCL rise time	t_R		300	ns	2
SCL clock frequency	t_{SCL}		400	KHz	
Data-in setup time	$t_{SU:DAT}$	100		ns	
Start condition setup time	$t_{SU:STA}$	600		ns	1
Stop condition setup time	$t_{SU:STO}$	600		ns	
WRITE cycle time	t_{WR}		10	ms	

NOTE:

1. For a reSTART condition, or following a WRITE cycle.
2. This parameter is sampled.
3. To avoid spurious START and STOP conditions, a minimum delay is placed between $SCL=1$ and the falling or rising edge of SDA.

Table 20: Serial Presence-Detect Matrix

"1"/"0": Serial Data, "driven to HIGH"/"driven to LOW"; notes appear following matrix

BYTE	DESCRIPTION	ENTRY (VERSION)	MT4VDDT1632U	MT4VDDT3232U
0	NUMBER OF SPD BYTES USED BY MICRON	128	80	80
1	TOTAL NUMBER OF BYTES IN SPD DEVICE	256	08	08
2	FUNDAMENTAL MEMORY TYPE	DDR SDRAM	07	07
3	NUMBER OF ROW ADDRESSES ON ASSEMBLY	12, 13	0C	0D
4	NUMBER OF COLUMN ADDRESSES ON ASSEMBLY	10	0A	0A
5	NUMBER OF PHYSICAL RANKS ON DIMM	1	01	01
6	MODULE DATA WIDTH	32	20	20
7	MODULE DATA WIDTH (continued)	0	00	00
8	MODULE VOLTAGE INTERFACE LEVELS (V _{DDQ})	SSTL 2.5V	04	04
9	SDRAM CYCLE TIME, (t _{CK}) (CAS LATENCY = 2.5)	6ns (-6) 7.5ns (-75)	60 75	60 75
10	SDRAM ACCESS FROM CLOCK (t _{AC}) (CAS LATENCY = 2.5)	0.7ns (-6) 0.75ns (-75)	70 75	70 75
11	MODULE CONFIGURATION TYPE	None	00	00
12	REFRESH RATE/TYPE	15.62μs, 7.8μs/SELF	80	82
13	SDRAM DEVICE WIDTH (PRIMARY DDR SDRAM)	8	08	08
14	ERROR-CHECKING DDR SDRAM DATA WIDTH	None	00	00
15	MINIMUM CLOCK DELAY, BACK-TO-BACK RANDOM COLUMN ACCESS	1 clock	01	01
16	BURST LENGTHS SUPPORTED	2, 4, 8	0E	0E
17	NUMBER OF BANKS ON DDR SDRAM DEVICE	4	04	04
18	CAS LATENCIES SUPPORTED	2, 2.5	0C	0C
19	CS LATENCY	0	01	01
20	WE LATENCY	1	02	02
21	SDRAM MODULE ATTRIBUTES	Unbuffered/Diff. Clock	20	20
22	SDRAM DEVICE ATTRIBUTES: GENERAL	Fast/Concurrent AP	C0	C0
23	SDRAM CYCLE TIME, (t _{CK}) (CAS latency = 2)	7.5ns (-6) 10ns (-75)	75 A0	75 A0
24	SDRAM ACCESS FROM CLOCK (t _{AC}) (CAS LATENCY = 2)	0.7ns (-6) 0.75ns (-75)	70 75	70 75
25	SDRAM CYCLE TIME, (t _{CK}) (CAS LATENCY = 1.5)	N/A	00	00
26	SDRAM ACCESS FROM CK, (t _{AC}) (CAS LATENCY = 1.5)	N/A	00	00
27	MINIMUM ROW PRECHARGE TIME, (t _{RP})	18ns (-6) 20ns (-75)	48 50	48 50
28	MINIMUM ROW ACTIVE TO ROW ACTIVE, (t _{RRD})	12ns (-6) 15ns (-75)	30 3C	30 3C
29	MINIMUM RAS# TO CAS# DELAY, (t _{RCD})	18ns (-6) 20ns (-75)	48 50	48 50
30	MINIMUM RAS# PULSE WIDTH, (t _{RAS}) (See note 1)	42ns (-6) 45ns (-75)	2A 2D	2A 2D
31	MODULE RANK DENSITY	64MB, 128MB	10	20

Table 20: Serial Presence-Detect Matrix (Continued)

"1"/"0": Serial Data, "driven to HIGH"/"driven to LOW"; notes appear following matrix

BYTE	DESCRIPTION	ENTRY (VERSION)	MT4VDDT1632U	MT4VDDT3232U
32	ADDRESS AND COMMAND SETUP TIME, (t_{IS}) [Value set to slow slew rate (t_{IS_s})] (See note 2)	0.8ns (-6) 1.0ns (-75)	80 A0	80 A0
33	ADDRESS AND COMMAND HOLD TIME, (t_{IH}); [Value set to slow slew rate (t_{IH_s})] (See note 2)	0.8ns (-6) 1.0ns (-75)	80 A0	80 A0
34	DATA/DATA MASK INPUT SETUP TIME, (t_{DS})	0.45ns (-6) 0.5ns 9-75)	45 50	45 50
35	DATA/DATA MASK INPUT HOLD TIME, (t_{DH})	0.45ns (-6) 0.5ns (-75)	45 50	45 50
36-40	RESERVED		00	00
41	MIN ACTIVE AUTO REFRESH TIME (t_{RC})	60ns (-6) 65ns (-75)	3C 41	3C 41
42	MINIMUM AUTO REFRESH TO ACTIVE/AUTO REFRESH COMMAND PERIOD, (t_{RFC})	72ns (-6) 75ns (-75)	48 4B	48 4B
43	SDRAM DEVICE MAX CYCLE TIME (t_{CKMAX})	12ns (-6) 13ns (-75)	30 34	30 34
44	SDRAM DEVICE MAX DQS-DQ SKEW TIME (t_{DQSQ})	0.45ns (-6) 0.5ns (-75)	2D 3C	2D 3C
45	SDRAM DEVICE MAX READ DATA HOLD SKEW FACTOR (t_{QHS})	0.6ns (-6) 0.75ns (-75)	60 75	60 75
46-61	RESERVED		00	00
62	SPD REVISION	Release 0.0	00	00
63	CHECKSUM FOR BYTES 0-62	-6 -75	CE B3	E1 C6
64	MANUFACTURER'S JEDEC ID CODE	MICRON	2C	2C
65-71	MANUFACTURER'S JEDEC ID CODE	(Continued)	FF	FF
72	MANUFACTURING LOCATION	01-11	01-B0	01-B0
73-90	MODULE PART NUMBER (ASCII)		Variable Data	Variable Data
91	PCB IDENTIFICATION CODE	1-9	01-09	01-09
92	IDENTIFICATION CODE (continued)	0	00	00
93	YEAR OF MANUFACTURE IN BCD		Variable Data	Variable Data
94	WEEK OF MANUFACTURE IN BCD		Variable Data	Variable Data
95-98	MODULE SERIAL NUMBER		Variable Data	Variable Data
99-127	MANUFACTURER-SPECIFIC DATA (RSVD)		-	-

NOTE:

1. The value of t_{RAS} used for -75 modules is calculated from $t_{RC} - t_{RP}$. Actual device spec. value is 40 ns.
2. The JEDEC SPD specification allows fast or slow slew rate values for these bytes. The worst-case (slow slew rate) value is represented here. Systems requiring the fast slew rate setup and hold values are supported, provided the faster minimum slew rate is met.



Figure 14: 100-Pin DIMM Dimensions

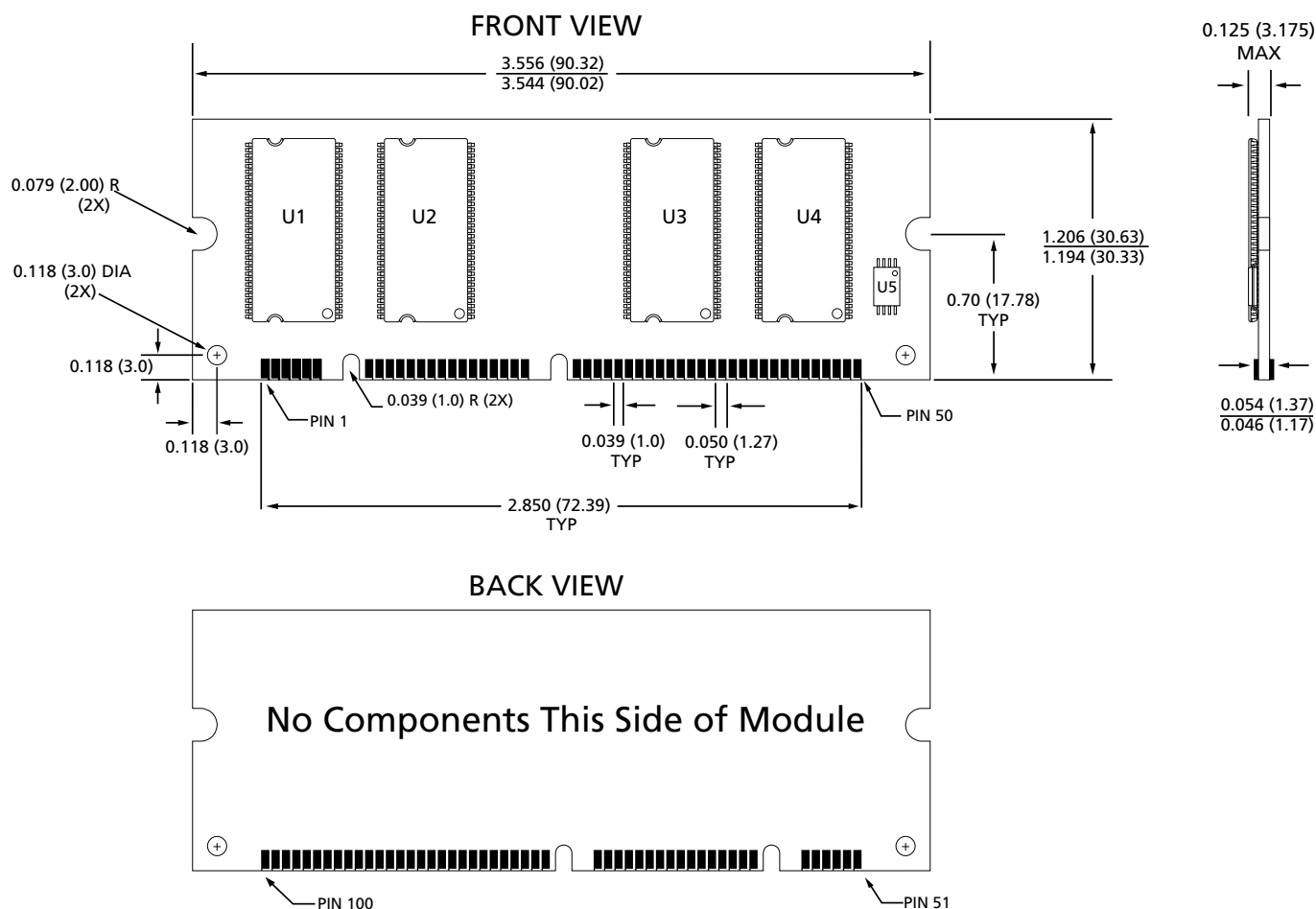

NOTE:

All dimensions in inches (millimeters) $\frac{MAX}{MIN}$ or typical where noted.

Data Sheet Designation

Advance: This data sheet contains initial descriptions of products still under development.



8000 S. Federal Way, P.O. Box 6, Boise, ID 83707-0006, Tel: 208-368-3900

E-mail: prodmtg@micron.com, Internet: <http://www.micron.com>, Customer Comment Line: 800-932-4992

Micron and the M logo are registered trademarks and the Micron logo is a trademark of Micron Technology, Inc.