

RoHS Compliant

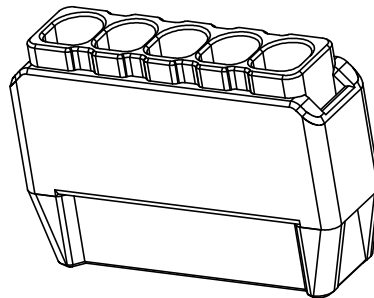
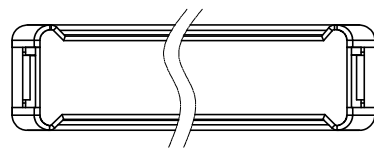
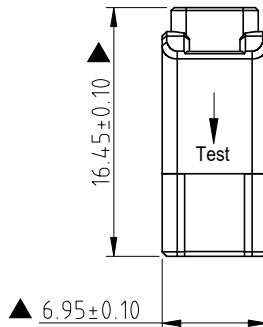
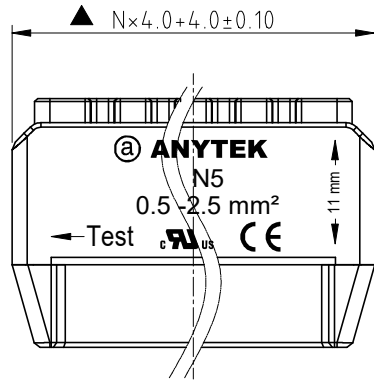
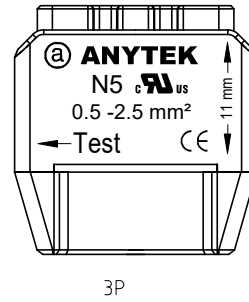
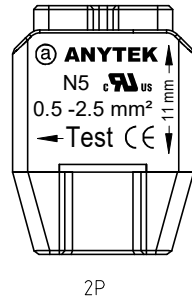
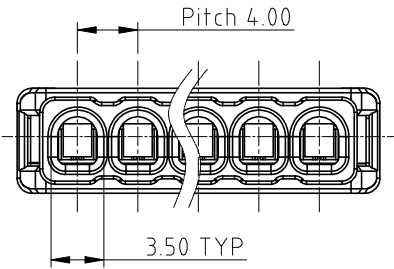

REV	SIGN	DATE	DESCRIPTION	APPROVER
A0		2020.07.13	Initial Release	LENA

THIS IS CAD DRAWING, DO NOT REVISE MANUALLY!!!

Electrical:

- Voltage rating: 300 V
- Current rating: 24 A
- Wire range(Solid wire AWG): 18-12 AWG
- Wire strip length: 11 mm
- Withstanding Voltage: 2.5KV
- Insulation Resistance: DV500V 500MΩ min
- Operating temperature: -40°C to +80°C
- Safety Approval: us

Part No. **N5xx00x00000G**

- NO. OF POLES
- 02: 2 POLES
  - 03: 3 POLES
  - 04: 4 POLES
  - 05: 5 POLES

- Body Color:
- 3 Orange(RAL2011/P)
  - 4 Yellow(RAL1018/A)
  - 5 Green(RAL6018/T)

RoHS compliant  
(lead<4%)  
In copper Alloy

**Amphenol**  
**ANYTEK**

**CUSTOMER COPY**

ALL RIGHTS RESERVED. REPRODUCTION OR ISSUE TO THIRD PARTIES IN ANY FORM WHATSOEVER IS NOT PERMITTED WITHOUT WRITTEN AUTHORITY FROM THE PROPRIETOR. PROPERTY OF ANYTEK TECHNOLOGY CO., LTD

TITLE		N5 Series ,pitch 4.00mm,T=6.95				
PART NO.		N5xx00x00000G		DWG NO.		8N50001
APPROVED	CHECKED	DESIGNED	DRAWN	CUST NO.		Tolerance
		LENA 2021.01.07	LENA 2021.01.07			X. ±0.50
						X.X ±0.30
						X.XX ±0.10
				SHEET: 01/01		X° ±1°
				UNIT: mm		
				SCALE: 2:1		
				REV.: A0		