

Data sheet | Item number: 750-8100
 Controller PFC100; 2 x ETHERNET; ECO

www.wago.com/750-8100

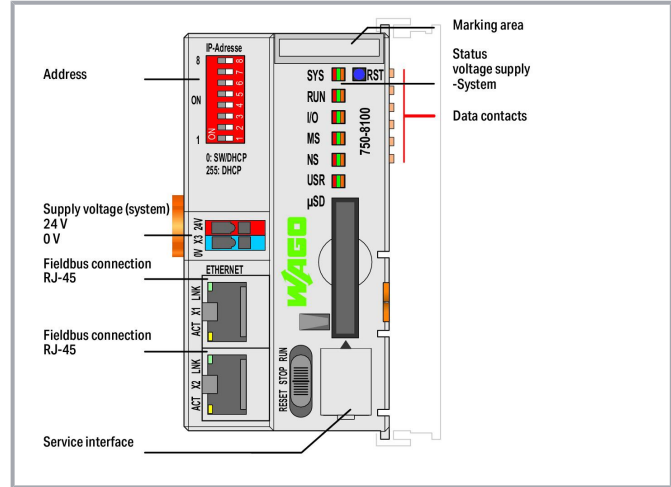

Color:

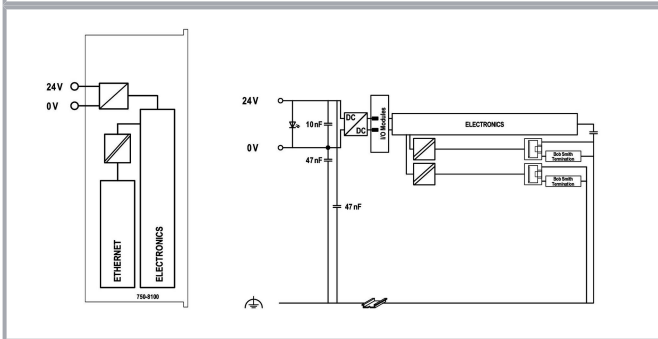

Subject to changes. Please also observe the further product documentation!

WAGO GmbH & Co. KG
 Hansastr. 27
 32423 Minden
 Phone: +49571 887-0 | Fax: +49571 887-169
 Email: info.de@wago.com | Web: www.wago.com

Do you have any questions about our products?
 We are always happy to take your call at +49 (571) 887-44222.



Item description

The PFC100 Controller is a compact PLC for the modular WAGO I/O System. Besides network and fieldbus interfaces, the controller supports all digital, analog and specialty I/O modules found within the 750/753 Series.

Two ETHERNET interfaces and an integrated switch enable line topology wiring.

An integrated Webserver provides user configuration options, while displaying PFC100 status information.

Besides the processing industry and building automation, typical applications for the PFC100 include standard machinery and equipment control (e.g., packaging, bottling and manufacturing systems, as well as textile, metal and wood processing machines).

The DIP switch configures the last byte of the IP address and may be used for IP address assignment.

Programming per IEC 61131-3

- Programmable via *e!COCKPIT*
- Direct connection of WAGO's I/O modules
- 2 x ETHERNET (configurable)
- Linux 3.18 operating system with RT-Preempt patch
- Configuration via *e!COCKPIT* or Web-Based Management interface
- Maintenance-free

Data

Technical data

Communication	Modbus (TCP, UDP) ETHERNET EtherNet/IP™ Adapter (slave), library for <i>e!RUNTIME</i> MQTT
ETHERNET protocols	DHCP DNS NTP FTP FTPS SNMP HTTP HTTPS SSH
Visualization	Web-Visu Web Visu
Operating system	Real-time Linux 3.18 (with RT-Preempt patch)
CPU	Cortex A8; 600 MHz
Programming languages per IEC 61131-3	Instruction List (IL) Ladder Diagram (LD)

Subject to changes. Please also observe the further product documentation!



Function Block Diagram (FBD)
 Continuous Function Chart (CFC)
 Structured Text (ST)
 Sequential Function Chart (SFC)

Programming environment	<i>e!COCKPIT</i> (based on CODESYS V3)
Configuration options	<i>e!COCKPIT</i> WAGO-I/O-CHECK Web-Based Management
Baud rate (communication/fieldbus 1)	10/100 Mbit/s
Baud rate	ETHERNET: 10/100 Mbit/s
Transmission medium (communication/fieldbus)	ETHERNET: Twisted Pair S-UTP; 100 Ω; Cat. 5; 100 m maximum cable length
Main memory (RAM)	256 MB
Internal memory (flash)	256 MB
Non-volatile hardware memory	64 Kbytes
Program memory	10 MB (Program and data memory (dynamically distributed))
Data memory	10 MB Program and data memory (dynamically distributed)
Non-volatile software memory	64. Kbytes
Type of memory card	microSD up to 32 GB (all guaranteed properties only valid with WAGO's memory card)
Memory card slot	Push-push mechanism; Cover lid (sealable)
Number of modules per node (max.)	250
Number of modules without a bus extension (max.)	64
Input and output process image (internal) max.	1000 words/1000 words
Input and output process image (Modbus®) max.	CODESYS V3: 32000 words/32000 words
Indicators	LED (SYS, RUN, I/O, USR) red/green/orange: Status system, program, local data bus, status programmable by user (can be used via CODESYS library)
Supply voltage (system)	24 VDC (-25 ... +30 %); via pluggable connector
Input current (typ.) at nominal load (24 V)	300 mA
Total current (system supply)	700 mA
Isolation	500 V system/field

Connection data

Connection technology: communication/fieldbus	Modbus (TCP, UDP): 2 x RJ-45
Connection technology: system supply	2 x CAGE CLAMP®
Connection type 1	System supply
Solid conductor	0.08 ... 1.5 mm ² / 28 ... 14 AWG
Fine-stranded conductor	0.08 ... 1.5 mm ² / 28 ... 14 AWG

Subject to changes. Please also observe the further product documentation!

WAGO GmbH & Co. KG
 Hansastr. 27
 32423 Minden
 Phone: +49571 887-0 | Fax: +49571 887-169
 Email: info.de@wago.com | Web: www.wago.com

Do you have any questions about our products?
 We are always happy to take your call at +49 (571) 887-44222.



Strip length	5 ... 6 mm / 0.2 ... 0.24 inches
Connection technology: device configuration	1 x Male connector; 4-pole

Physical data

Width	49.5 mm / 1.949 inches
Height	96.8 mm / 3.811 inches
Depth	71.9 mm / 2.831 inches
Depth from upper-edge of DIN-rail	64.7 mm / 2.547 inches

Mechanical Data

Weight	112 g
Color	light gray
Housing material	Polycarbonate; polyamide 6.6
Conformity marking	CE

Environmental requirements

Ambient temperature (operation)	0 ... +55 °C
Ambient temperature (storage)	-25 ... +85 °C
Protection type	IP20
Pollution degree	2 per IEC 61131-2
Operating altitude	without temperature derating: 0 ... 2000 m; with temperature derating: 2000 ... 5000 m (0.5 K/100 m); 5000 m (max.)
Relative humidity (without condensation)	95 %
Mounting position	any
Mounting type	DIN-35 rail
Vibration resistance	4g per IEC 60068-2-6
Shock resistance	15g per IEC 60068-2-27
EMC immunity to interference	per EN 61000-6-2, marine applications
EMC emission of interference	per EN 61000-6-3, marine applications
Exposure to pollutants	Per IEC 60068-2-42 and IEC 60068-2-43
Fire load	1.458 MJ
Permissible H ₂ S contaminant concentration at a relative humidity 75 %	10 ppm
Permissible SO ₂ contaminant concentration at a relative humidity 75 %	25 ppm

Subject to changes. Please also observe the further product documentation!

WAGO GmbH & Co. KG
 Hansastr. 27
 32423 Minden
 Phone: +49571 887-0 | Fax: +49571 887-169
 Email: info.de@wago.com | Web: www.wago.com

Do you have any questions about our products?
 We are always happy to take your call at +49 (571) 887-44222.



Commercial data

eCl@ss 10.0	27-24-26-07
eCl@ss 9.0	27-24-26-07
ETIM 8.0	EC000236
ETIM 7.0	EC000236
PU (SPU)	1 pcs
Packaging type	box
Country of origin	DE
GTIN	4055143351805
Customs tariff number	85371091990

Environmental Product Compliance

CAS-No.	1314-23-4 1317-36-8 693-98-1 7439-92-1
REACH Candidate List Substance	2-methylimidazole Lead Lead monoxide Zirconium Oxide
RoHS Compliance Status	Compliant,With Exemption
RoHS Exemption	6(c) 7(a) 7(c)-I 7(c)-II
SCIP notification number (Austria)	44ac1bd9-da91-4a6c-a048-18a9ee0f5855
SCIP notification number (Belgium)	2b57b90b-2c69-4883-a71b-c39b9a21fa31
SCIP notification number (Bulgaria)	2b76aaf7-e352-4386-bcbf-58eadb79890c
SCIP notification number (Czech Republic)	2b9d3f18-9ee7-4fc2-a295-4282fc95481a
SCIP notification number (Denmark)	19b4ade4-d41d-4c19-91a8-0f4d3df6e7b7
SCIP notification number (Finland)	b6cf7d5f-5c88-42bb-83e4-8ece2948b4d3
SCIP notification number (France)	3ac0823a-507b-4ed9-b15e-52d8fa4d587a
SCIP notification number (Germany)	55e7e947-8d4a-4517-af63-22a5745d4b61
SCIP notification number (Hungary)	93318ce0-44c0-41e5-b27e-b40441e1029b
SCIP notification number (Italy)	28303ec6-2fcd-4e5b-ada4-dff8e2b93de9
SCIP notification number (Netherlands)	7f680757-16fd-4b3e-b74a-fd43be8ded2e
SCIP notification number (Poland)	1fd0226c-78b2-4f39-811f-4ca08c4460fb
SCIP notification number (Romania)	f3923381-47a0-496f-be1c-7ed7c4f60787

Subject to changes. Please also observe the further product documentation!

WAGO GmbH & Co. KG
Hansastr. 27
32423 Minden
Phone: +49571 887-0 | Fax: +49571 887-169
Email: info.de@wago.com | Web: www.wago.com



Do you have any questions about our products?
We are always happy to take your call at +49 (571) 887-44222.

SCIP notification number (Sweden)

44058643-5ee6-4d79-a6b2-c839b0a54352

Approvals / Certificates





General approvals

Logo	Approval	Additional Approval Text	Certificate name
	EAC Brjansker Zertifizierungsstelle	TP TC 020/2011	EAC RU C-DE.AM02. B.00087 /19
	KC National Radio Research Agency	Article 58-2, Clause 3	MSIP-REM-W43-PFC750
	UL Underwriters Laboratories Inc. (ORDINARY LOCATIONS)	UL 508	E175199 Sec.1

Declarations of conformity and manufacturer's declarations

Logo	Approval	Additional Approval Text	Certificate name
	EU-Declaration of Conformity WAGO GmbH & Co. KG	-	-





Approvals for marine applications

Logo	Approval	Additional Approval Text	Certificate name
	ABS American Bureau of Shipping	-	22-2219060
	BSH Bundesamt fuer Seeschifffahrt und Hydrographie	-	1104
	BV Bureau Veritas S.A.	Rules for class. of Steel Ships	66711/A0
	DNV DNV GL SE	DNV-CG-0339, Aug. 2021	TAA0000194

Subject to changes. Please also observe the further product documentation!

WAGO GmbH & Co. KG
 Hansastr. 27
 32423 Minden
 Phone: +49571 887-0 | Fax: +49571 887-169
 Email: info.de@wago.com | Web: www.wago.com

Do you have any questions about our products?
 We are always happy to take your call at +49 (571) 887-44222.

	KR Korean Register of Shipping	-	KR HMB05880-AC001
	LR Lloyds Register EMEA	-	LR22180952TA
	PRS Polski Rejestr Statków	-	TE/2236/880590/19
	RINA RINA Germany GmbH	-	ELE343521XG001

Approvals for hazardous areas

Logo	Approval	Additional Approval Text	Certificate name
	ATEX TUEV Nord Cert GmbH	EN 60079-0	TUEV_14_ATEX_148929_X (II 3 G Ex ec IIC T4 Gc)
	CCC CNEX	CNCA-C23-01	2020312310000213 (Ex ec IIC T4 Gc)
	EAC Brjansker Zertifizierungsstelle	TP TC 012/2011	EAC RU C-DE.AM02.B.00163 /19 (2Ex e IIC T4 Gc X)
	IECEX TUEV Nord Cert GmbH	IEC 60079-0	IECEX TUN 14.0035 X (Ex ec IIC T4 Gc)
	INMETRO TÜV Rheinland do Brasil Ltda.	IEC 60079-0	BR-Ex_TÜV 12.1297 X
	UKEx WAGO GmbH & Co. KG	EN 60079-0	UKCA_WAGO22UKEX003X_ec

Subject to changes. Please also observe the further product documentation!

WAGO GmbH & Co. KG
Hansastr. 27
32423 Minden
Phone: +49571 887-0 | Fax: +49571 887-169
Email: info.de@wago.com | Web: www.wago.com

Do you have any questions about our products?
We are always happy to take your call at +49 (571) 887-44222.



UL
Underwriters Laboratories Inc. (HAZARDOUS
LOCATIONS)

UL 121201

E198726 Sec.1

Optional accessories

Carrier rail

Mounting accessories

	Item no.: 210-197 Steel carrier rail; 35 x 15 mm; 1.5 mm thick; 2 m long; slotted; similar to EN 60715; silver-colored	www.wago.com/210-197
	Item no.: 210-198 Copper carrier rail; 35 x 15 mm; 2.3 mm thick; 2 m long; unslotted; according to EN 60715; copper-colored	www.wago.com/210-198
	Item no.: 210-504 Steel carrier rail; 35 x 7.5 mm; 1 mm thick; 2 m long; slotted; galvanized; according to EN 60715; silver-colored	www.wago.com/210-504
	Item no.: 210-505 Steel carrier rail; 35 x 7.5 mm; 1 mm thick; 2 m long; unslotted; galvanized; according to EN 60715; silver-colored	www.wago.com/210-505
	Item no.: 210-506 Steel carrier rail; 35 x 15 mm; 1.5 mm thick; 2 m long; unslotted; galvanized; similar to EN 60715; silver-colored	www.wago.com/210-506
	Item no.: 210-508 Steel carrier rail; 35 x 15 mm; 1.5 mm thick; 2 m long; slotted; galvanized; similar to EN 60715; silver-colored	www.wago.com/210-508
	Item no.: 210-113 Steel carrier rail; 35 x 7.5 mm; 1 mm thick; 2 m long; unslotted; according to EN 60715; silver-colored	www.wago.com/210-113
	Item no.: 210-118 Steel carrier rail; 35 x 15 mm; 2.3 mm thick; 2 m long; unslotted; according to EN 60715; silver-colored	www.wago.com/210-118
	Item no.: 210-112 Steel carrier rail; 35 x 7.5 mm; 1 mm thick; 2 m long; slotted; according to EN 60715; "Hole width 25 mm; silver-colored	www.wago.com/210-112
	Item no.: 210-114 Steel carrier rail; 35 x 15 mm; 1.5 mm thick; 2 m long; unslotted; similar to EN 60715; silver-colored	www.wago.com/210-114
	Item no.: 210-115 Steel carrier rail; 35 x 7.5 mm; 1 mm thick; 2 m long; slotted; according to EN 60715; "Hole width 18 mm; silver-colored	www.wago.com/210-115
	Item no.: 210-196 Aluminum carrier rail; 35 x 8.2 mm; 1.6 mm thick; 2 m long; unslotted; similar to EN 60715; silver-colored	www.wago.com/210-196

Subject to changes. Please also observe the further product documentation!

WAGO GmbH & Co. KG
Hansastr. 27
32423 Minden
Phone: +49571 887-0 | Fax: +49571 887-169
Email: info.de@wago.com | Web: www.wago.com

Do you have any questions about our products?
We are always happy to take your call at +49 (571) 887-44222.

Memory card

Memory card



Item no.: 758-879/000-3102
Memory Card SD Micro; 2 GByte

www.wago.com/758-879/000-3102



Item no.: 758-879/000-3108
Memory Card SD Micro; pSLC-NAND; 8 GB; Temperature range: -40 to 90°C

www.wago.com/758-879/000-3108

Communication

Communication cable



Item no.: 750-923
Configuration cable; USB connector; Length: 2.5 m

www.wago.com/750-923



Item no.: 750-923/000-001
Configuration cable; USB connector; Length: 5 m

www.wago.com/750-923/000-001

Marking accessories

Marker

Item no.: 2009-145/000-006
Mini-WSB Inline; for Smart Printer; 1700 pieces on roll; stretchable 5 - 5.2 mm; plain; snap-on type; blue

www.wago.com/2009-145/000-006

Item no.: 2009-145
Mini-WSB Inline; for Smart Printer; 1700 pieces on roll; stretchable 5 - 5.2 mm; plain; snap-on type; white

www.wago.com/2009-145

Item no.: 2009-145/000-002
Mini-WSB Inline; for Smart Printer; 1700 pieces on roll; stretchable 5 - 5.2 mm; plain; snap-on type; yellow

www.wago.com/2009-145/000-002

Item no.: 2009-145/000-007
Mini-WSB Inline; for Smart Printer; 1700 pieces on roll; stretchable 5 - 5.2 mm; plain; snap-on type; gray

www.wago.com/2009-145/000-007

Item no.: 2009-145/000-005
Mini-WSB Inline; for Smart Printer; 1700 pieces on roll; stretchable 5 - 5.2 mm; plain; snap-on type; red

www.wago.com/2009-145/000-005

Item no.: 2009-145/000-012
Mini-WSB Inline; for Smart Printer; 1700 pieces on roll; stretchable 5 - 5.2 mm; plain; snap-on type; orange













www.wago.com/2009-145/000-012

Item no.: 2009-145/000-023
Mini-WSB Inline; for Smart Printer; 1700 pieces on roll; stretchable 5 - 5.2 mm; plain; snap-on type; green

www.wago.com/2009-145/000-023





Item no.: 2009-145/000-024

Subject to changes. Please also observe the further product documentation!

	Mini-WSB Inline; for Smart Printer; 1700 pieces on roll; stretchable 5 - 5.2 mm; plain; snap-on type; violet	www.wago.com/2009-145/000-024
	Item no.: 248-501/000-006 Mini-WSB marking card; as card; not stretchable; plain; snap-on type; blue	www.wago.com/248-501/000-006
	Item no.: 248-501/000-007 Mini-WSB marking card; as card; not stretchable; plain; snap-on type; gray	www.wago.com/248-501/000-007
	Item no.: 248-501/000-002 Mini-WSB marking card; as card; not stretchable; plain; snap-on type; yellow	www.wago.com/248-501/000-002
	Item no.: 248-501/000-012 Mini-WSB marking card; as card; not stretchable; plain; snap-on type; orange	www.wago.com/248-501/000-012
	Item no.: 248-501 Mini-WSB marking card; as card; not stretchable; plain; snap-on type; white	www.wago.com/248-501
	Item no.: 248-501/000-017 Mini-WSB marking card; as card; not stretchable; plain; snap-on type; light green	www.wago.com/248-501/000-017
	Item no.: 248-501/000-005 Mini-WSB marking card; as card; not stretchable; plain; snap-on type; red	www.wago.com/248-501/000-005
	Item no.: 248-501/000-024 Mini-WSB marking card; as card; not stretchable; plain; snap-on type; violet	www.wago.com/248-501/000-024
	Item no.: 248-501/000-023 Mini-WSB marking card; as card; not stretchable; plain; snap-on type; green	www.wago.com/248-501/000-023
Shield termination		
Shield clamping saddles		
	Item no.: 790-116 Shield clamping saddle; 19 mm wide; diameter of compatible conductor; 7 ... 16 mm	www.wago.com/790-116
	Item no.: 790-124 Shield clamping saddle; 27 mm wide; diameter of compatible conductor; 6 ... 24 mm	www.wago.com/790-124
	Item no.: 790-108	www.wago.com/790-108











Subject to changes. Please also observe the further product documentation!

Shield clamping saddle; 11 mm wide; diameter of compatible conductor; 3 ... 8 mm

	Item no.: 790-140 Shield clamping saddle; diameter of compatible conductor	www.wago.com/790-140
	Item no.: 790-216 Shield clamping saddle; 21.8 mm wide; 6 ... 16 mm	www.wago.com/790-216
	Item no.: 790-220 Shield clamping saddle; 30 mm wide; 6 ... 20 mm	www.wago.com/790-220
	Item no.: 790-208 Shield clamping saddle; 12.4 mm wide; 3 ... 8 mm	www.wago.com/790-208

System housing

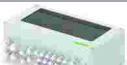
System enclosure

	Item no.: 850-814/002-000 IP65 enclosure; Sheet steel (RAL 7035); WxHxD (200x120x200 mm); without flange plate	www.wago.com/850-814/002-000
	Item no.: 850-815/002-000 IP65 enclosure; Sheet steel (RAL 7035); WxHxD (300x120x200 mm); without flange plate	www.wago.com/850-815/002-000
	Item no.: 850-816/002-000 IP65 enclosure; Sheet steel (RAL 7035); WxHxD (400x120x200 mm); without flange plate	www.wago.com/850-816/002-000
	Item no.: 850-817/002-000 IP65 enclosure; Sheet steel (RAL 7035); WxHxD (600x120x200 mm); without flange plate	www.wago.com/850-817/002-000
	Item no.: 850-825 IP65 enclosure; Aluminium (RAL 7032); WxHxD (160x100x160 mm); 9 x M12, 4 x M20	www.wago.com/850-825
	Item no.: 850-826 IP65 enclosure; Aluminium (RAL 7032); WxHxD (240x100x160 mm); 4 x M20, 4 x M16, 14 x M12 cable grip	www.wago.com/850-826
	Item no.: 850-827 IP65 enclosure; Aluminium (RAL 7032); WxHxD (320x100x160 mm); 4 x M20, 8 x M16, 17 x M12 cable grip	www.wago.com/850-827
	Item no.: 850-827/002-000 IP65 enclosure; Aluminium (RAL 7035); WxHxD (320x100x160 mm); 4 x M20, 8 x M16, 17 x M12 cable grip	www.wago.com/850-827/002-000
	Item no.: 850-826/002-000 IP65 enclosure; Aluminium (RAL 7035); WxHxD (240x100x160 mm); 4 x M20, 4 x M16, 14 x M12 cable grip	www.wago.com/850-826/002-000
	Item no.: 850-828/002-000 IP65 enclosure; Aluminium (RAL 7035); WxHxD (480x100x160 mm); 4 x M20, 10 x M16, 35 x M12 cable grip	www.wago.com/850-828/002-000

Subject to changes. Please also observe the further product documentation!



Item no.: 850-828

IP65 enclosure; Aluminium (RAL 7032); WxHxD (480x100x160 mm); 4 x M20, 10 x M16, 35 x M12 cable grip www.wago.com/850-828



Item no.: 850-834

IP65 enclosure; Polyester (RAL 7032); WxHxD (164x100x164 mm); 9 x M12, 4 x M20 www.wago.com/850-834



Item no.: 850-835

IP65 enclosure; Polyester (RAL 7032); WxHxD (244x100x164 mm); 4 x M20, 4 x M16, 14 x M12 cable grip www.wago.com/850-835



Item no.: 850-836

IP65 enclosure; Polyester (RAL 7032); WxHxD (324x100x164 mm); 4 x M20, 8 x M16, 17 x M12 cable grip www.wago.com/850-836

Cables and pluggable connectors

Connector plug



Item no.: 750-975

ETHERNET RJ-45 connector, IP20; ETHERNET 10/100 Mbit/s; for field assembly www.wago.com/750-975



Item no.: 750-978/000-012

Connector ETHERNET; RJ-45; Cat. 6A; straight; Code T568B; AWG 22; Strain relief www.wago.com/750-978/000-012



Item no.: 750-979/000-012

Connector ETHERNET; RJ-45; Cat. 6A; angled; Code T568B; AWG 22; Strain relief www.wago.com/750-979/000-012



Item no.: 750-978/000-021

Connector ETHERNET; RJ-45; Cat. 6A; straight; Code T568A; AWG 24; Strain relief www.wago.com/750-978/000-021



Item no.: 750-979/000-022

Connector ETHERNET; RJ-45; Cat. 6A; angled; Code T568B; AWG 24; Strain relief www.wago.com/750-979/000-022



Item no.: 750-978/000-022

Connector ETHERNET; RJ-45; Cat. 6A; straight; Code T568B; AWG 24; Strain relief www.wago.com/750-978/000-022



Item no.: 750-979/000-011

Connector ETHERNET; RJ-45; Cat. 6A; angled; Code T568A; AWG 22; Strain relief www.wago.com/750-979/000-011



Item no.: 750-979/000-021

Connector ETHERNET; RJ-45; Cat. 6A; angled; Code T568A; AWG 24; Strain relief www.wago.com/750-979/000-021



Item no.: 750-977/000-011

Connector ETHERNET; RJ-45; Cat. 6A; straight; Code T568A; AWG 22 www.wago.com/750-977/000-011

Subject to changes. Please also observe the further product documentation!

WAGO GmbH & Co. KG

Hansastr. 27

32423 Minden

Phone: +49571 887-0 | Fax: +49571 887-169

Email: info.de@wago.com | Web: www.wago.com

Do you have any questions about our products?

We are always happy to take your call at +49 (571) 887-44222.



Item no.: 750-978/000-011
Connector ETHERNET; RJ-45; Cat. 6A; straight; Code T568A; AWG 22; Strain relief

www.wago.com/750-978/000-011



Item no.: 750-977/000-022
Connector ETHERNET; RJ-45; Cat. 6A; straight; Code T568B; AWG 24

www.wago.com/750-977/000-022



Item no.: 750-977/000-012
Connector ETHERNET; RJ-45; Cat. 6A; straight; Code T568B; AWG 22

www.wago.com/750-977/000-012



Item no.: 750-977/000-021
Connector ETHERNET; RJ-45; Cat. 6A; straight; Code T568A; AWG 24

www.wago.com/750-977/000-021

Software

Basic version



Item no.: 2759-101/1110-2005
e!COCKPIT; Multi-User License; 05 pcs

www.wago.com/2759-101/1110-2005



Item no.: 2759-101/1110-2002
e!COCKPIT; Workstation License

www.wago.com/2759-101/1110-2002



Item no.: 2759-101/1110-2015
e!COCKPIT; Multi-User License; 15 pcs

www.wago.com/2759-101/1110-2015



Item no.: 2759-101/1110-2020
e!COCKPIT; Multi-User License; 20 pcs

www.wago.com/2759-101/1110-2020



Item no.: 2759-101/1110-2010
e!COCKPIT; Multi-User License; 10 pcs

www.wago.com/2759-101/1110-2010



Item no.: 2759-101/1110-3000
e!COCKPIT; Site License

www.wago.com/2759-101/1110-3000



Item no.: 2759-101/1110-4000
e!COCKPIT; Buy-out License

www.wago.com/2759-101/1110-4000

Downloads

Documentation

Manual

System Manual WAGO I/O System 750/753

Subject to changes. Please also observe the further product documentation!

WAGO GmbH & Co. KG
Hansastr. 27
32423 Minden
Phone: +49571 887-0 | Fax: +49571 887-169
Email: info.de@wago.com | Web: www.wago.com

Do you have any questions about our products?
We are always happy to take your call at +49 (571) 887-44222.



Decentralized Automation Technology	V 3.3.0 2023 May 4	pdf 8.8 MB	Download
PFC100 CS 2ETH ECO Controller PFC100; 2 x ETHERNET; ECO	1.12.0 2022 Aug 29	pdf 5.0 MB	Download
System Manual Series 750/753 Online HTML		URL	Download
Bid Text			
750-8100 X81 - Datei	2019 Feb 19	xml 7.2 kB	Download
750-8100 doc - Datei	2016 Jan 6	doc 34.8 kB	Download
ausschreiben.de 750-8100		URL	Download
Instruction Leaflet			
CCC Ex (Additional information) WAGO-I/O-SYSTEM *750-****/*	2023 Apr 26	pdf 163.6 kB	Download
Tutorial			
Set IP address with Ethernet Settings In this video we are demonstrating how you can set a IP address with Ethernet Settings. Content: 00:27 – Chapter #1 Download and install software; 00:56 – Chapter #2 Open Ethernet Settings; 01:10 – Chapter #3 Establish serial Connection; 01:34 – Chapter #4 Set IP address; 02:10 – Chapter #5 Check IP address	3.0 2017 Dec 18	mp4 88.3 MB	Download
Establish connection to a controller using SSH In this video we are demonstrating how to establish a SSH connection with a controller using for example PuTTY to be able to work with the LINUX console. Contents: 0:21 Download and install the SSH client; 0:40 Establish the SSH connection; 0:50 Log on to the Controller	1.0 2017 Aug 5	mp4 29.0 MB	Download
Additional Information			
Disposal and Recycling Electrical and electronic equipment, Batteries, Packaging	V 1.1.0 2022 Aug 18	pdf 2.2 MB	Download
WAGO OPC UA Server	V 1.1.0 2021 Jan 28	pdf 1.2 MB	Download

Subject to changes. Please also observe the further product documentation!



External license agreement for open source software In Wago products	V 1.0.0	pdf 1.5 MB	Download
---	---------	---------------	----------

System Description

Overview on WAGO-I/O-SYSTEM 750 approvals		pdf 789.0 kB	Download
---	--	-----------------	----------

Application Notes

Application Note CoDeSys 2.3

Application note Cloud Connectivity	2019-09-17	zip	Download
This application note explains how the WAGO controllers PFC100 and PFC200 can communicate with cloud services like Microsoft Azure (WAGO Cloud), Amazon AWS and IBM Bluemix. Data could be send to the cloud and commands could receive from the cloud. The libraries WagoLibCloud for WAGO-I/O-PRO V2.3 and WagoAppCloud for e!COCKPIT are used.	2019 Sep 17	4.1 MB	

Application Note e!COCKPIT

e!COCKPIT application note WagoAppCloud	2022-11-04	zip	Download
This application note explains how the WAGO controllers PFC100 and PFC200 can communicate with cloud services like Microsoft Azure (WAGO Cloud), Amazon AWS and IBM Bluemix. Data could be send to the cloud and commands could receive from the cloud. The library WagoAppCloud for e!COCKPIT is used.	2022 Nov 4	2.7 MB	

Libraries

Library

Library WagoLibCloud_02.lib	2.2.4	zip	Download
Die Bibliothek dient zur Kommunikation des WAGO Controller PFC100 und PFC200 mit Cloud Diensten wie Microsoft Azure (WAGO Cloud), Amazon AWS and IBM Bluemix. Daten können zur Cloud gesendet und Kommandos von der Cloud empfangen werden.	2020 Jan 21	57.6 kB	

Engineering-Software

e!COCKPIT

e!COCKPIT	1.11.2.0	zip	Download
Register at no cost and test our engineering software for 30 days.	2023 Apr 24	4.1 GB	

Subject to changes. Please also observe the further product documentation!



Desktop Application

WAGOupload

URL

Download

WAGOupload is a stand-alone PC software for transferring, backing up and restoring PLC applications on WAGO 750 Series controllers.

Configuration and Commissioning Software

(759-316) WAGO Ethernet Settings / Serie 750

06.18.01.01
2023 Feb 28

zip
27.3 MB

Download

Runtime Software

GitHub: Linux® Toolchain

GitHub: Linux® Software Development Kit (SDK)

URL

Download

With the PFC SDK, WAGO offers Linux® enthusiasts the opportunity to compile the PFC firmware themselves, and to expand it according to their own wishes.

The WAGO PFC SDK includes a Pengutronix build environment, optimized for the PFC, and the OSELAS Toolchain, which open up the following possibilities, among others:

- Expanding the firmware functions using open source packages like: Python, SQLite3, PHP, etc.
- Compiling their own C/C++ applications with direct or indirect bus access to the local bus, CANopen, or PROFIBUS.
- Compiling external libraries using CODESYS V2 to expand the PLC applications.
- There are detailed instructions for many of these tasks and ideas (see WAGO GitHub HowTo's).

Firmware

Image Update (SD Karte) PFC100/200

V 22 SP1
2022 Dec 12

zip
210.8 MB

Download

WAGO_FW0750-8xxx_V031010_IX22_SP1_I

WUP Update (WAGOuploadTool) PFC100/200

V 22 SP1
2022 Dec 12

zip
208.5 MB

Download

WAGO_FW0750-8xxx_V031010_IX22_SP1_W

IoT/ Cloud

"Remote Access" Beta Software

"Remote Access" Beta Software

Subject to changes. Please also observe the further product documentation!

WAGO GmbH & Co. KG

Hansastr. 27

32423 Minden

Phone: +49571 887-0 | Fax: +49571 887-169

Email: info.de@wago.com | Web: www.wago.com

Do you have any questions about our products?

We are always happy to take your call at +49 (571) 887-44222.



Register for the beta version of "Remote Access" for the WAGO Cloud.

V 0.12.0.0
2020 Dec 6

ZIP
2.1 MB

[Download](#)

CAD/CAE-Data

CAE data

EPLAN Data Portal 750-8100	URL	Download
--	---------------------	--------------------------

WSCAD Universe 750-8100	URL	Download
---	---------------------	--------------------------

ZUKEN Portal 750-8100	URL	Download
---------------------------------------	---------------------	--------------------------

CAD data

2D/3D Models 750-8100	URL	Download
---------------------------------------	---------------------	--------------------------

Environmental Product Compliance

Compliance Search

Environmental Product Compliance 750-8100 Controller PFC100; 2 x ETHERNET; ECO	URL	Download
--	---------------------	--------------------------

Installation Notes

Product family

Controller 750
[Show all products from the family](#)

Subject to changes. Please also observe the further product documentation!