

Recommended Panel Cut-out

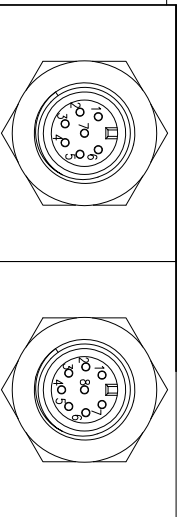

7 Pin

P/N: 21007515-03

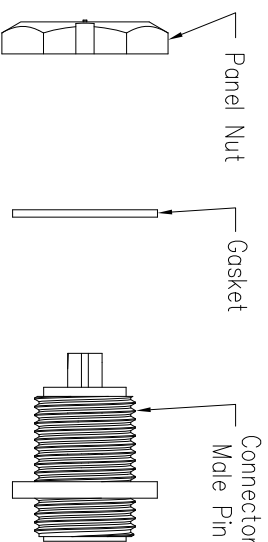
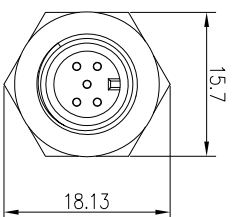
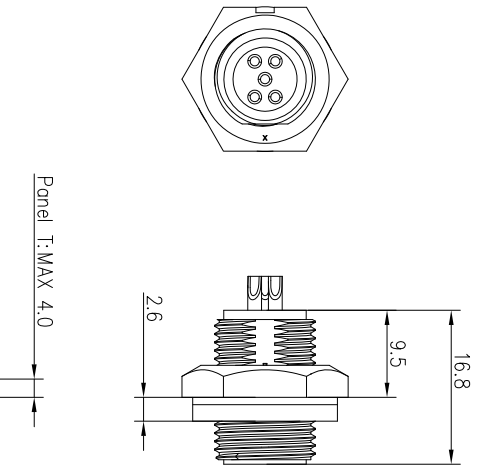
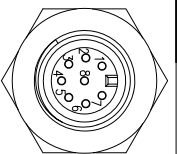

8 Pin

P/N: 21008515-03

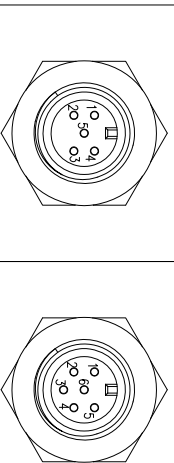

5 Pin

P/N: 21005515-03

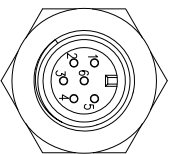

6 Pin

P/N: 21006515-03

Pin Assignments Front View

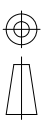

DESCRIPTION
Mini Series Screw Type
Rear Mount With Male Pin

TOLERANCE
.X
.XX
.XXX
ANGLES

SCALE: 4:5
SHEET 1 OF 1
REV: C1
SIZE A4
*: Inspection Item

CHOGORI

- Specification:
1. Operation Temperature: -45°C~105°C.
 2. Insulation Resistance: 100MΩ at DC 500V.
 3. Contact Resistance: <10mΩ.
 4. Withstand Voltage: 1300V AC.
 5. Operating Current: 2A.
 6. Operating Voltage: AC 110V.
 7. Waterproof Rate: IP67(Mated).
 8. Connector: Nylon+GF, Black.
 9. Panel Nut: Nylon, Black.
 10. Gasket: Silicon, Gray.
 11. Male Pin: Copper Alloy Gold Plated.
 12. Torque Rate: 0.5~0.7N • m.
 13. RoHS Compliant.
 14. UL Compliant.
 15. Mating Cap P/N: 806-00028-00

REV.	ECN NO.	DESCRIPTION	SIGN	DATE
C1	N/A	INITIAL DRAWING	Victory	2019/08/23

PART NO	DRAWN BY	DATE
21XXX515-03	Victory	2019/08/23
DWG NO	CHECKED BY	DATE
	Ivan	2019/08/23
CUSTOMER	APPROVED BY	DATE
	Ponson	2019/08/23