

LEP100F

LEP 100 F -24 -□

① ② ③ ④ ⑤

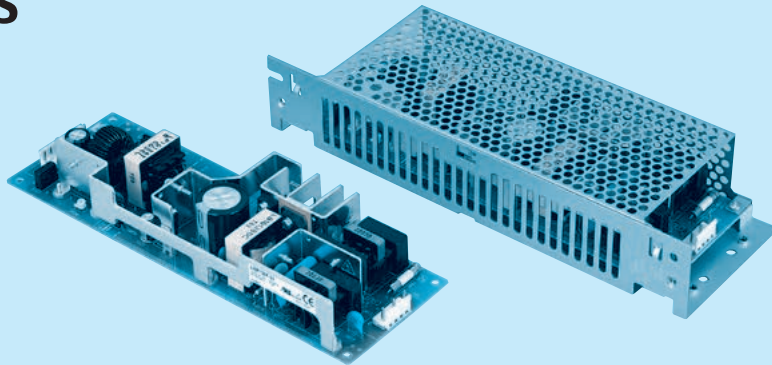

Example recommended EMI/EMC filter
NAC-06-472



High voltage pulse noise type : NAP series
Low leakage current type : NAM series
* A higher current rating EMI/EMC filter may be recommended in view of the other devices that could be connected in parallel with the power supply.

- ① Series name
- ② Output wattage
- ③ Universal input
- ④ Output voltage
- ⑤ Optional *1 *6
- G : Low leakage current
- R : with Remote ON/OFF
- S : with Chassis
- SN : with Chassis & cover
- T : Vertical terminal block
- U : Operating stop voltage is set at a lower value
- Z : with ZT

* Make sure necessary tests will be carried out on your end equipment with the power supply installed in accordance with any required EMC/EMI regulations.

MODEL	LEP100F-24	LEP100F-36	LEP100F-48
DC OUTPUT	+24V 4.2(Peak 7)A	+36V 2.8(Peak 4.7)A	+48V 2.1(Peak 3.5)A

SPECIFICATIONS

	MODEL	LEP100F-24	LEP100F-36	LEP100F-48	
INPUT	VOLTAGE[V]	AC85 - 264 1 φ or DC 120 - 370			
	CURRENT[A]	ACIN 100V	1.4typ (Io=100%)		
		ACIN 200V	0.7typ (Io=100%)		
	FREQUENCY[Hz]	50/60 (47 - 63) or DC			
	EFFICIENCY[%]	ACIN 100V	81typ (Io=100%)	82typ (Io=100%)	83typ (Io=100%)
		ACIN 200V	84typ (Io=100%)	85typ (Io=100%)	85typ (Io=100%)
	POWER FACTOR	ACIN 100V	0.98typ (Io=100%)		
ACIN 200V		0.93typ (Io=100%)			
INRUSH CURRENT[A]	ACIN 100V	15typ (Io=100%) (At cold start) (Ta=25°C)			
	ACIN 200V	30typ (Io=100%) (At cold start) (Ta=25°C)			
LEAKAGE CURRENT[ma]	0.75max (60Hz, According to IEC60950 and DEN-AN)				
OUTPUT	VOLTAGE[V]	+24	+36	+48	
	CURRENT[A]	*2 0 - 4.2 (Peak 7)	0 - 2.8 (Peak 4.7)	0 - 2.1 (Peak 3.5)	
	WATTAGE[W]	100.8 (Peak 168)	100.8 (Peak 169.2)	100.8 (Peak 168)	
	LINE REGULATION[mV]	48max	48max	48max	
	LOAD REGULATION[mV]	76max	90max	150max	
	RIPPLE[mVp-p]	0 to +50°C *3	120max	120max	150max
		-10 - 0°C *3	160max	160max	300max
	RIPPLE NOISE[mVp-p]	0 to +50°C *3	150max	150max	250max
		-10 - 0°C *3	180max	180max	350max
	TEMPERATURE REGULATION[mV]	0 to +50°C	120max	150max	240max
		-10 to +50°C	145max	180max	300max
	DRIFT[mV]	*4 48max	48max	48max	
	START-UP TIME[ms]	500max (ACIN 100V, Io=100%)			
HOLD-UP TIME[ms]	20typ (ACIN 100V, Io=100%)				
OUTPUT VOLTAGE ADJUSTMENT RANGE[V]	21.4 - 26.4	26.4 - 39.6	39.6 - 52.8		
OUTPUT VOLTAGE SETTING[V]	23.0 - 25.0	35.0 - 37.0	46.0 - 50.0		
PROTECTION CIRCUIT AND OTHERS	OVERCURRENT PROTECTION	Works over 101% of peak current and recovers automatically			
	OVERVOLTAGE PROTECTION	Works at 115 - 140% of rating			
	REMOTE ON/OFF	Option (Refer to Instruction Manual)			
ISOLATION	INPUT-OUTPUT · RC	*5 AC3.000V 1minute, Cutoff current = 10mA, DC500V 50MΩ min (At Room Temperature)			
	INPUT-FG	AC2.000V 1minute, Cutoff current = 10mA, DC500V 50MΩ min (At Room Temperature)			
	OUTPUT · RC-FG	*5 AC500V 1minute, Cutoff current = 100mA, DC500V 50MΩ min (At Room Temperature)			
	OUTPUT-RC	*5 AC100V 1minute, Cutoff current = 100mA, DC100V 10MΩ min (At Room Temperature)			
ENVIRONMENT	OPERATING TEMP., HUMID. AND ALTITUDE	-10 to +70°C, 20 - 90%RH (Non condensing) (Refer to DERATING CURVE), 3,000m (10,000feet) max			
	STORAGE TEMP., HUMID. AND ALTITUDE	-20 to +75°C, 20 - 90%RH (Non condensing), 9,000m (30,000feet) max			
	VIBRATION	10 - 55Hz, 19.6m/s ² (2G), 3minutes period, 60minutes each along X, Y and Z axis			
SAFETY AND NOISE REGULATIONS	IMPACT	196.1m/s ² (20G), 11ms, once each X, Y and Z axis			
	AGENCY APPROVALS	UL60950-1, C-UL(CSA60950-1), EN60950-1, EN60065, EN50178 Complies with DEN-AN and IEC60950-1 (At only AC input)			
	CONDUCTED NOISE	Complies with FCC-B, CISPR22-B, EN55022-B, VCCI-B			
	HARMONIC ATTENUATOR	Complies with IEC61000-3-2 *7			
OTHERS	CASE SIZE/WEIGHT	75 x 35 x 222mm [2.95 x 1.38 x 8.74 inches] (W x H x D) /380g max (with chassis & cover : 650g max)			
	COOLING METHOD	Convection			

*1 Specification is changed at option, refer to Instruction Manual 6.
 *2 Peak loading for 10sec. And Duty 35% max, refer to Instruction Manual 5. In detail.
 *3 This is the value that measured on measuring board with capacitor of 22 μF within 150mm from output terminal. Measured by 20MHz oscilloscope or Ripple-Noise meter (Equivalent to KEISOKU-GIKEN: RM101).
 *4 Drift is the change in DC output for an eight hour period after a half-hour warm-up at 25°C, with the input voltage held constant at the rated input/output.

*5 Applicable when remote control (optional) is added.
 *6 Please contact us about safety approvals for the model with option.
 *7 Please contact us about class C.
 * Parallel operation with other model is not possible.
 * Derating is required when operated with chassis and cover.
 * A sound may occur from power supply at peak loading.

External view

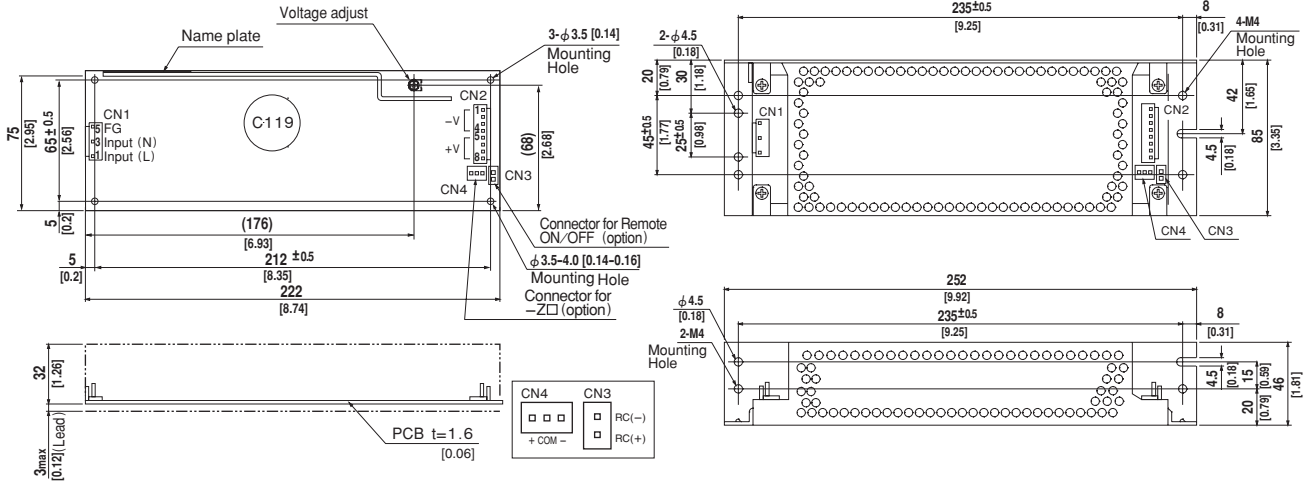

I / O Connector	Mating Connector	Terminal
CN1	B3P5-VH	VHR-5N
CN2	B8P-VH	VHR-8N
CN3 (Option)	B2B-XH-A	XHP-2
CN4 (Option)	B3B-XH-A	XHP-3

CN1	
Pin No.	Input
1	AC(L)
2	AC(N)
3	AC(N)
4	AC(N)
5	FG

(PIN CONNECTION)

CN2	
Pin No.	Output
1, 2, 3, 4	-V
5, 6, 7, 8	+V

CN3 (Option)	
Pin No.	Remote ON/OFF
1	RC(+)
2	RC(-)

CN4 (Option)	
Pin No.	-Z□
1	+
2	COM
3	-

- ※Weight: 380g max (with chassis & cover : 650g max)
- ※Tolerance: ±1 [±0.04]
- ※Dimensions in mm, []=inches
- ※PCB Material : CEM3
- ※Chassis and cover is optional.
- ※Mounting torque: 1.5N · m(16kgf · cm)max

(Mfr: J.S.T.)

※Keep drawing current per pin below 5A(7A at peak load)for CN2

Performance data

RISE TIME & FALL TIME (LEP100F-24)

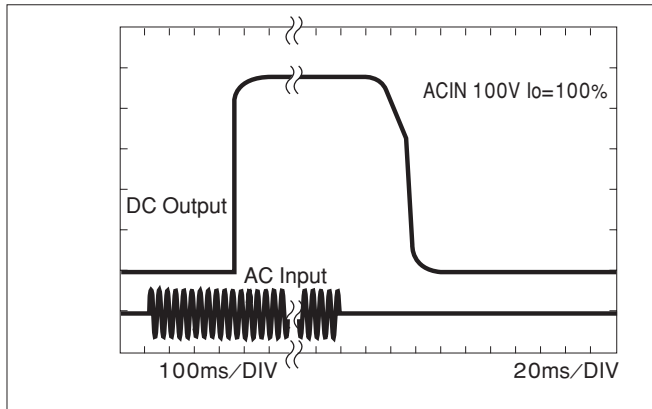

EFFICIENCY (LEP100F-24)

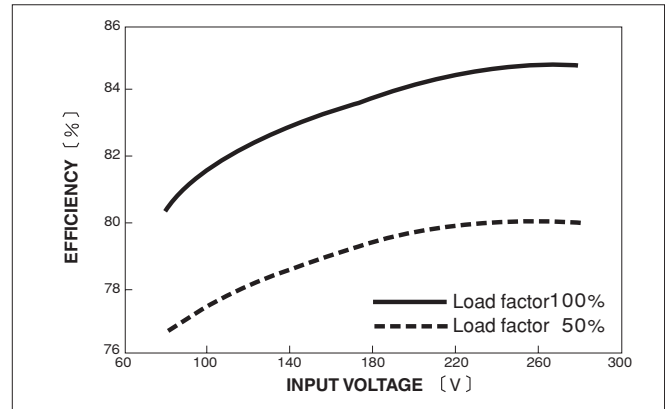

INPUT HARMONIC CURRENT (LEP100F-24)

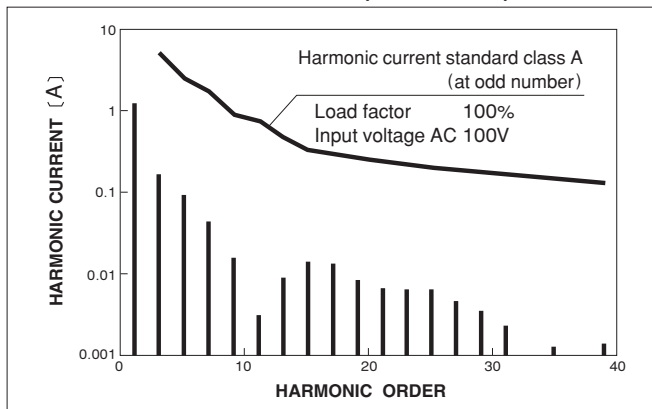

INPUT HARMONIC CURRENT (LEP100F-24)

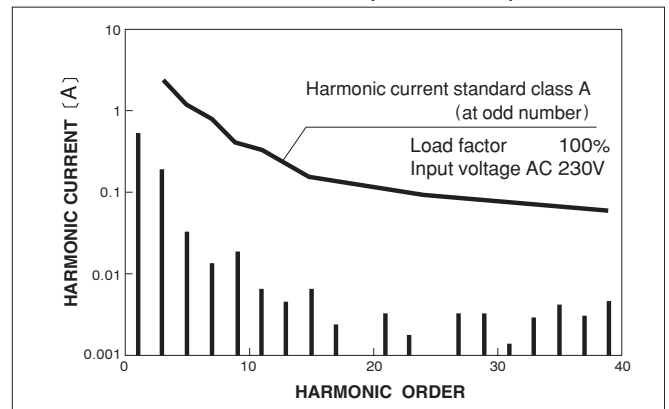

LEP150F

LEP 150 F -24 -□

① ② ③ ④ ⑤

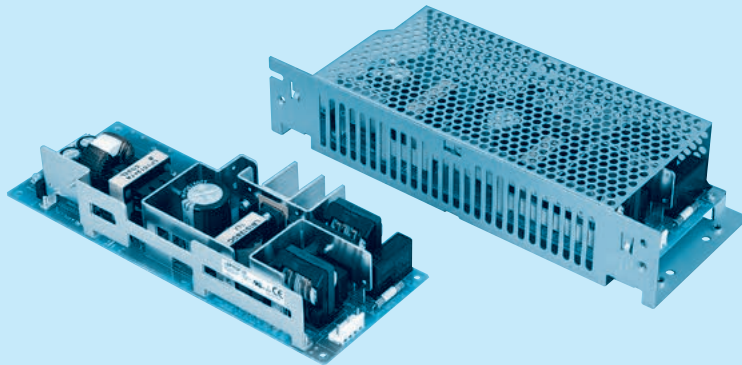

Example recommended EMI/EMC filter
NAC-06-472



High voltage pulse noise type : NAP series
Low leakage current type : NAM series
* A higher current rating EMI/EMC filter may be recommended in view of the other devices that could be connected in parallel with the power supply.

- ① Series name
- ② Output wattage
- ③ Universal input
- ④ Output voltage
- ⑤ Optional *1 *6
- G :Low leakage current
- R :with Remote ON/OFF
- S :with Chassis
- SN:with Chassis & cover
- T :Vertical terminal block
- U :Operating stop voltage is set at a lower value
- Z :with ZT

*Make sure necessary tests will be carried out on your end equipment with the power supply installed in accordance with any required EMC/EMI regulations.

MODEL	LEP150F-24	LEP150F-36	LEP150F-48
DC OUTPUT	+24V 6.3(Peak 12)A	+36V 4.2(Peak 8)A	+48V 3.2(Peak 6)A

SPECIFICATIONS

	MODEL	LEP150F-24	LEP150F-36	LEP150F-48	
INPUT	VOLTAGE[V]	AC85 - 264 1 φ or DC 120 - 370			
	CURRENT[A]	ACIN 100V	2.0typ (Io=100%)		
		ACIN 200V	1.0typ (Io=100%)		
	FREQUENCY[Hz]	50/60 (47 - 63) or DC			
	EFFICIENCY[%]	ACIN 100V	82typ (Io=100%)	83typ (Io=100%)	84typ (Io=100%)
		ACIN 200V	85typ (Io=100%)	86typ (Io=100%)	87typ (Io=100%)
	POWER FACTOR	ACIN 100V	0.98typ (Io=100%)		
		ACIN 200V	0.93typ (Io=100%)		
INRUSH CURRENT[A]	ACIN 100V	15typ (Io=100%) (At cold start) (Ta=25°C)			
	ACIN 200V	30typ (Io=100%) (At cold start) (Ta=25°C)			
LEAKAGE CURRENT[ma]	0.75max (60Hz, According to IEC60950 and DEN-AN)				
OUTPUT	VOLTAGE[V]	+24	+36	+48	
	CURRENT[A]	*2 0 - 6.3 (Peak 12)	0 - 4.2 (Peak 8)	0 - 3.2 (Peak 6)	
	WATTAGE[W]	151.2 (Peak 288)	151.2 (Peak 288)	153.6 (Peak 288)	
	LINE REGULATION[mV]	48max	48max	48max	
	LOAD REGULATION[mV]	76max	90max	150max	
	RIPPLE[mVp-p]	0 to +45°C *3	120max	120max	150max
		-10 - 0°C *3	160max	160max	300max
	RIPPLE NOISE[mVp-p]	0 to +45°C *3	150max	150max	250max
		-10 - 0°C *3	180max	180max	350max
	TEMPERATURE REGULATION[mV]	0 to +45°C	120max	150max	240max
		-10 to +45°C	145max	180max	300max
	DRIFT[mV]	*4 48max	48max	48max	
	START-UP TIME[ms]	500max (ACIN 100V, Io=100%)			
	HOLD-UP TIME[ms]	20typ (ACIN 100V, Io=100%)			
OUTPUT VOLTAGE ADJUSTMENT RANGE[V]	21.4 - 26.4	26.4 - 39.6	39.6 - 52.8		
OUTPUT VOLTAGE SETTING[V]	23.0 - 25.0	35.0 - 37.0	46.0 - 50.0		
PROTECTION CIRCUIT AND OTHERS	OVERCURRENT PROTECTION	Works over 101% of peak current and recovers automatically			
	OVERVOLTAGE PROTECTION	Works at 115 - 140% of rating			
	REMOTE ON/OFF	Option (Refer to Instruction Manual)			
ISOLATION	INPUT-OUTPUT · RC	*5 AC3.000V 1minute, Cutoff current = 10mA, DC500V 50MΩ min (At Room Temperature)			
	INPUT-FG	AC2.000V 1minute, Cutoff current = 10mA, DC500V 50MΩ min (At Room Temperature)			
	OUTPUT · RC-FG	*5 AC500V 1minute, Cutoff current = 100mA, DC500V 50MΩ min (At Room Temperature)			
	OUTPUT-RC	*5 AC100V 1minute, Cutoff current = 100mA, DC100V 10MΩ min (At Room Temperature)			
ENVIRONMENT	OPERATING TEMP.,HUMID.AND ALTITUDE	-10 to +70°C, 20 - 90%RH (Non condensing) (Refer to DERATING CURVE), 3,000m (10,000feet) max			
	STORAGE TEMP.,HUMID.AND ALTITUDE	-20 to +75°C, 20 - 90%RH (Non condensing), 9,000m (30,000feet) max			
	VIBRATION	10 - 55Hz, 19.6m/s ² (2G), 3minutes period, 60minutes each along X, Y and Z axis			
SAFETY AND NOISE REGULATIONS	IMPACT	196.1m/s ² (20G), 11ms, once each X, Y and Z axis			
	AGENCY APPROVALS	UL60950-1, C-UL(CSA60950-1), EN60950-1, EN60065, EN50178 Complies with DEN-AN and IEC60950-1 (At only AC input)			
	CONDUCTED NOISE	Complies with FCC-B, CISPR22-B, EN55022-B, VCCI-B			
	HARMONIC ATTENUATOR	Complies with IEC61000-3-2 *7			
OTHERS	CASE SIZE/WEIGHT	85 x 40 x 222mm [3.35 x 1.57 x 8.74 inches] (W x H x D) /490g max (with chassis & cover : 830g max)			
	COOLING METHOD	Convection			

*1 Specification is changed at option, refer to Instruction Manual 6.
 *2 Peak loading for 10sec. And Duty 35% max, refer to Instruction Manual 5. In detail.
 *3 This is the value that measured on measuring board with capacitor of 22 μF within 150mm from output terminal.Measured by 20MHz oscilloscope or Ripple-Noise meter (Equivalent to KEISOKU-GIKEN: RM101).
 *4 Drift is the change in DC output for an eight hour period after a half-hour warm-up at 25°C, with the input voltage held constant at the rated input/output.

*5 Applicable when remote control (optional) is added.
 *6 Please contact us about safety approvals for the model with option.
 *7 Please contact us about class C.
 * Parallel operation with other model is not possible.
 * Derating is required when operated with chassis and cover.
 * A sound may occur from power supply at peak loading.

External view

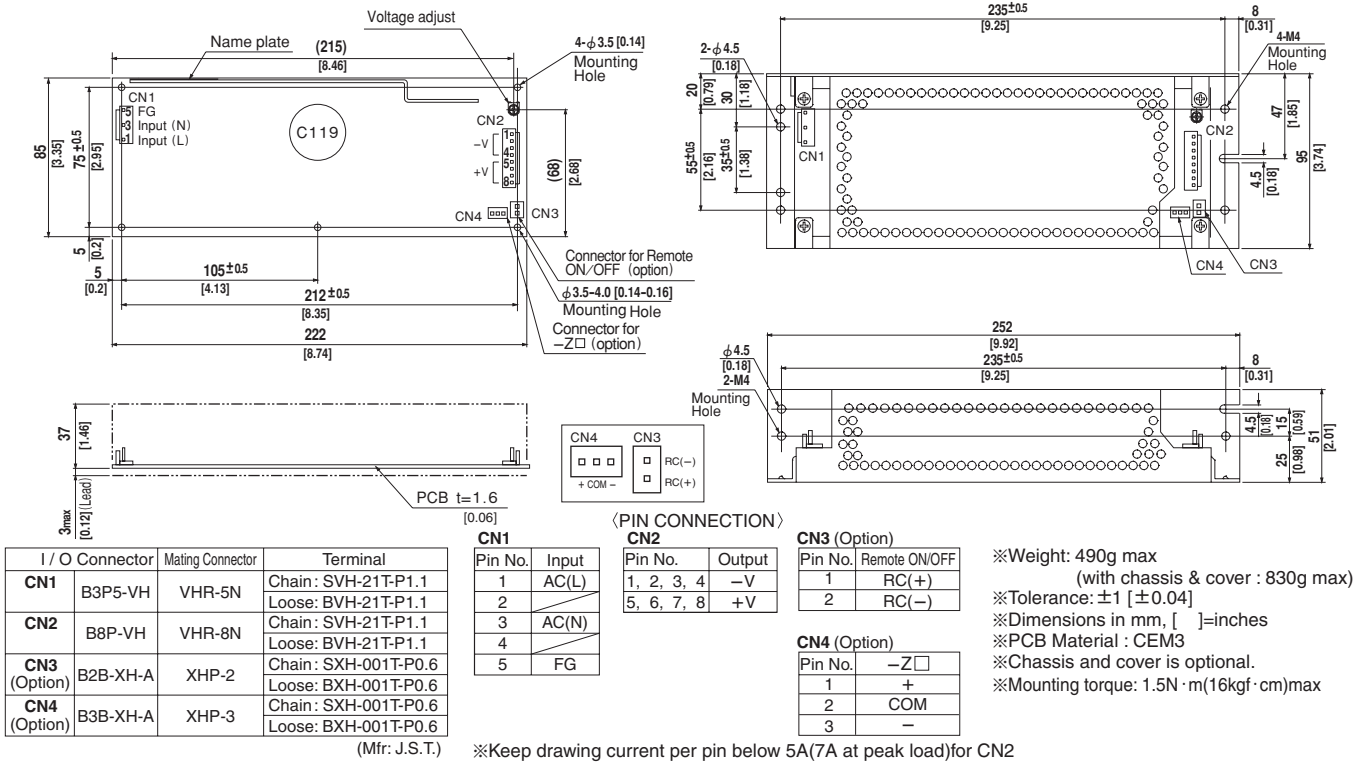

Performance data

RISE TIME & FALL TIME (LEP150F-24)

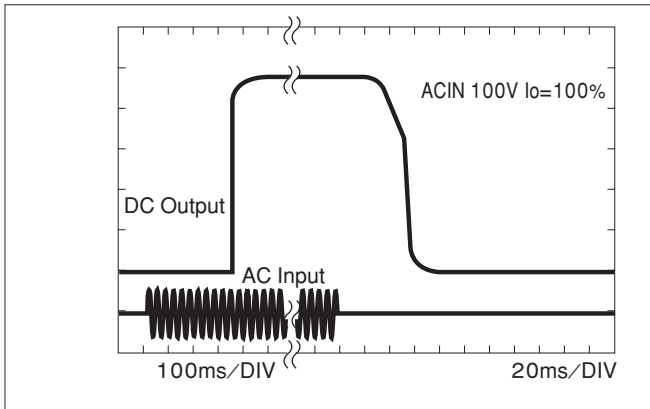

EFFICIENCY (LEP150F-24)

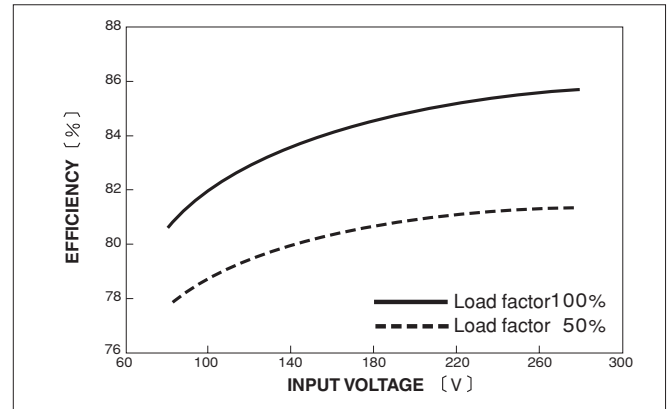

INPUT HARMONIC CURRENT (LEP150F-24)

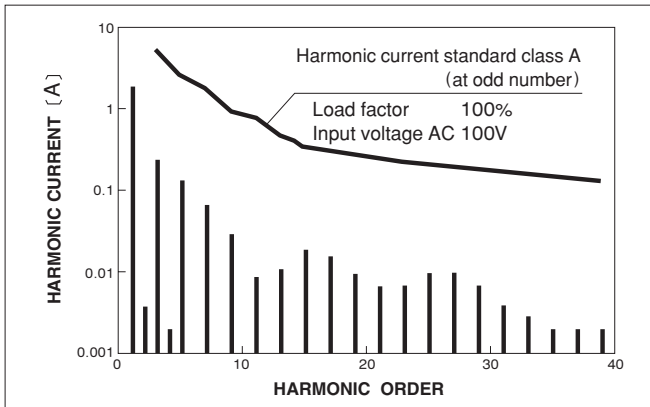

INPUT HARMONIC CURRENT (LEP150F-24)

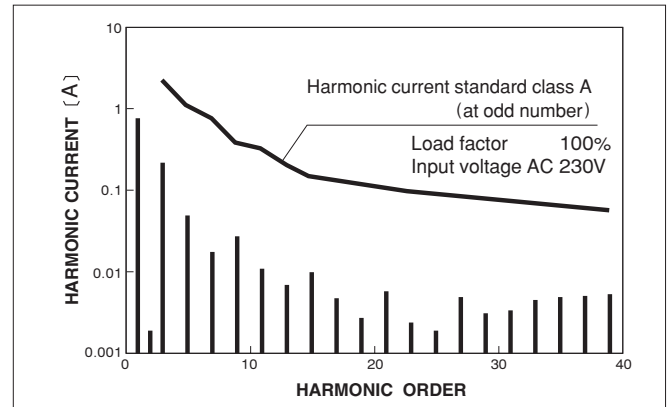

LEP240F

LEP 240 F -24 -□

① ② ③ ④ ⑤

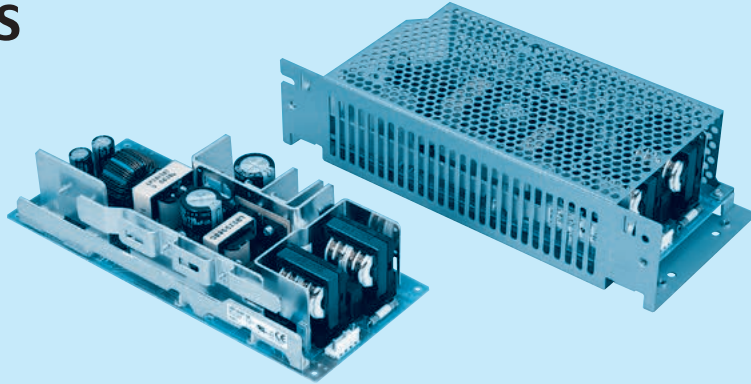

Example recommended EMI/EMC filter
NAC-06-472



High voltage pulse noise type : NAP series
Low leakage current type : NAM series
* A higher current rating EMI/EMC filter may be recommended in view of the other devices that could be connected in parallel with the power supply.

- ① Series name
- ② Output wattage
- ③ Universal input
- ④ Output voltage
- ⑤ Optional *1 *6
- G :Low leakage current
- R :with Remote ON/OFF
- S :with Chassis
- SN:with Chassis & cover
- T :Vertical terminal block
- U :Operating stop voltage is set at a lower value
- Z :with ZT

*Make sure necessary tests will be carried out on your end equipment with the power supply installed in accordance with any required EMC/EMI regulations.

MODEL	LEP240F-24	LEP240F-36	LEP240F-48
DC OUTPUT	+24V 10(Peak 20)A	+36V 6.7(Peak 13.4)A	+48V 5(Peak 10)A

SPECIFICATIONS

	MODEL	LEP240F-24	LEP240F-36	LEP240F-48	
INPUT	VOLTAGE[V]	AC85 - 264 1 φ or DC 120 - 370			
	CURRENT[A]	ACIN 100V	3.3typ (Io=100%)		
		ACIN 200V	1.7typ (Io=100%)		
	FREQUENCY[Hz]	50/60 (47 - 63) or DC			
	EFFICIENCY[%]	ACIN 100V	83typ (Io=100%)	84typ (Io=100%)	84typ (Io=100%)
		ACIN 200V	86typ (Io=100%)	87typ (Io=100%)	87typ (Io=100%)
	POWER FACTOR	ACIN 100V	0.98typ (Io=100%)		
		ACIN 200V	0.93typ (Io=100%)		
INRUSH CURRENT[A]	ACIN 100V	15typ (Io=100%) (More than 3sec.to re-start)			
	ACIN 200V	30typ (Io=100%) (More than 3sec.to re-start)			
LEAKAGE CURRENT[mA]	0.75max (60Hz, According to IEC60950 and DEN-AN)				
OUTPUT	VOLTAGE[V]	+24	+36	+48	
	CURRENT[A]	*2 0 - 10 (Peak 20)	0 - 6.7 (Peak 13.4)	0 - 5 (Peak 10)	
	WATTAGE[W]	240.0 (Peak 480)	241.2 (Peak 482.4)	240.0 (Peak 480)	
	LINE REGULATION[mV]	48max	48max	48max	
	LOAD REGULATION[mV]	76max	90max	150max	
	RIPPLE[mVp-p]	0 to +40°C *3	120max	120max	150max
		-10 - 0°C *3	160max	160max	300max
	RIPPLE NOISE[mVp-p]	0 to +40°C *3	150max	150max	250max
		-10 - 0°C *3	180max	180max	350max
	TEMPERATURE REGULATION[mV]	0 to +40°C	120max	150max	240max
		-10 to +40°C	145max	180max	300max
	DRIFT[mV]	*4 48max	48max	48max	
	START-UP TIME[ms]	500max (ACIN 100V, Io=100%)			
HOLD-UP TIME[ms]	20typ (ACIN 100V, Io=100%)				
OUTPUT VOLTAGE ADJUSTMENT RANGE[V]	21.4 - 26.4	26.4 - 39.6	39.6 - 52.8		
OUTPUT VOLTAGE SETTING[V]	23.0 - 25.0	35.0 - 37.0	46.0 - 50.0		
PROTECTION CIRCUIT AND OTHERS	OVERCURRENT PROTECTION	Works over 101% of peak current and recovers automatically			
	OVERVOLTAGE PROTECTION	Works at 115 - 140% of rating			
	REMOTE ON/OFF	Option (Refer to Instruction Manual)			
ISOLATION	INPUT-OUTPUT · RC	*5 AC3,000V 1minute, Cutoff current = 10mA, DC500V 50MΩ min (At Room Temperature)			
	INPUT-FG	AC2,000V 1minute, Cutoff current = 10mA, DC500V 50MΩ min (At Room Temperature)			
	OUTPUT · RC-FG	*5 AC500V 1minute, Cutoff current = 100mA, DC500V 50MΩ min (At Room Temperature)			
	OUTPUT-RC	*5 AC100V 1minute, Cutoff current = 100mA, DC100V 10MΩ min (At Room Temperature)			
ENVIRONMENT	OPERATING TEMP.,HUMID.AND ALTITUDE	-10 to +70°C, 20 - 90%RH (Non condensing) (Refer to DERATING CURVE), 3,000m (10,000feet) max			
	STORAGE TEMP.,HUMID.AND ALTITUDE	-20 to +75°C, 20 - 90%RH (Non condensing), 9,000m (30,000feet) max			
	VIBRATION	10 - 55Hz, 19.6m/s ² (2G), 3minutes period, 60minutes each along X, Y and Z axis			
SAFETY AND NOISE REGULATIONS	IMPACT	196.1m/s ² (20G), 11ms, once each X, Y and Z axis			
	AGENCY APPROVALS	UL60950-1, C-UL(CSA60950-1), EN60950-1, EN60065, EN50178 Complies with DEN-AN and IEC60950-1 (At only AC input)			
	CONDUCTED NOISE	Complies with FCC-B, CISPR22-B, EN55022-B, VCCI-B			
OTHERS	HARMONIC ATTENUATOR	Complies with IEC61000-3-2 *7			
	CASE SIZE/WEIGHT	95 × 45 × 222mm [3.74 × 1.77 × 8.74 inches] (W×H×D) /690g max (with chassis & cover : 1,070g max)			
	COOLING METHOD	Convection			

*1 Specification is changed at option, refer to Instruction Manual 6.
 *2 Peak loading for 10sec. And Duty 35% max, refer to Instruction Manual 5. In detail.
 *3 This is the value that measured on measuring board with capacitor of 22 μF within 150mm from output terminal.Measured by 20MHz oscilloscope or Ripple-Noise meter (Equivalent to KEISOKU-GIKEN: RM101).
 *4 Drift is the change in DC output for an eight hour period after a half-hour warm-up at 25°C, with the input voltage held constant at the rated input/output.

*5 Applicable when remote control (optional) is added.
 *6 Please contact us about safety approvals for the model with option.
 *7 Please contact us about class C.
 * Parallel operation with other model is not possible.
 * Derating is required when operated with chassis and cover.
 * A sound may occur from power supply at peak loading.

