

Product Change Notice

Date:	May 7, 2020
Overview:	Production of seven fans has been stopped due to the discontinuation of a component needed to manufacture them
Reason for Change:	UTC has discontinued transistor PN BU941ZL-TA3-T
Affected Part No(s):	G2G085-AB04-10 W2G110-AK43-83 G2G097-AA26-09 W2G110-AK67-24 W2G110-AG43-01 W2G115-AG71-12 W2G110-AK43-31
Design Change Detail:	Production of these fans is stopped indefinitely. We have possible alternatives for three of the fans and are working to see if any of the original fans can be brought back into production with a new PCB & transistor design. We will provide information as it becomes available; however, we strongly recommend moving to the alternatives as we may not be able to produce the original fans again.
Effective Date:	Immediately
Last Time Buy Deadline:	N/A
Pricing:	N/A
ebm-papst employee:	Jeannine Zenobi
Attachments:	Listing of possible alternatives for three of the PNs with corresponding datasheets for reference
Comments:	Always review the application specifications to ensure the best product solution

Possible Alternatives

	W2G110-AK43-31	4184NXH	4184NXHR
Voltage Range (V)	16-28	12-28	12-28
Nominal Speed (RPM)	4400	4400	4400
Wattage (W)	15	11	11
Blade Material	Aluminum	Plastic	Plastic
Housing Material	Aluminum	Aluminum	Aluminum
Ambient Temperature (C)	-25...70	-30...70	-30...70
Humidity	H0+	H0	H1
Size (mm)	119 x119 x 38	119 x 119 x 38	119 x 119 x 38

	W2G110-AK43-83	4114NXHR
Voltage Range (V)	16-28	12-28
Nominal Speed (RPM)	4400	4400
Wattage (W)	15	11
Blade Material	Aluminum	Plastic
Housing Material	Aluminum	Aluminum
Ambient Temperature (C)	-25...70	-30...70
Humidity	H1	H1
Size (mm)	119 x 119 x 38	119 x119 x 38

	W2G115-AG71-12	5214NHH	DV5214NU
Voltage Range (V)	16-28	16-30	18-26.4
Nominal Speed (RPM)	4050	4900	4930
Wattage (W)	12	17.5	19.8
Blade Material	Aluminum	Plastic	Plastic
Housing Material	Aluminum	Plastic	Plastic
Ambient Temperature (C)	-25...72	-20...65	-20...65
Humidity	H1	H0	H2
Size (mm)	127 x 127 x 38	127 x 127 x 38	127 x 127 x 38

Form No: 1274	Quality Record - No	Page 1 of 1
Rev. – Orig, Released 08/28/14	Retention Period – 1 year	Dept. Owner – Sales/Marketing

ebm-papst Mulfingen GmbH & Co. KG

Bachmühle 2 · D-74673 Mulfingen

Phone +49 7938 81-0

Fax +49 7938 81-110

info1@de.ebmpapst.com

www.ebmpapst.com

Limited partnership · Headquarters Mulfingen

Amtsgericht (court of registration) Stuttgart · HRA 590344

General partner Elektrobau Mulfingen GmbH · Headquarters Mulfingen

Amtsgericht (court of registration) Stuttgart · HRB 590142

Nominal data

Type	W2G110-AK43-31	
Motor	M2G045-BA	
Nominal voltage	VDC	24
Nominal voltage range	VDC	16 .. 28
Method of obtaining data		fa
Speed (rpm)	min ⁻¹	4400
Power consumption	W	15
Max. back pressure	Pa	100
Max. back pressure	in. wg	0.4
Min. ambient temperature	°C	-25
Max. ambient temperature	°C	72

ml = Max. load · me = Max. efficiency · fa = Free air · cs = Customer specification · ce = Customer equipment
 Subject to change



Technical description

Weight	0.49 kg
Size	110 mm
Motor size	45
Rotor surface	Painted black
Blade material	Sheet steel, painted black
Fan housing material	Die-cast aluminum, painted black
Number of blades	5
Airflow direction	A
Direction of rotation	Counterclockwise, viewed toward rotor
Degree of protection	IP22
Insulation class	"B"
Moisture (F) / Environmental (H) protection class	H0+
Max. permitted ambient temp. for motor (transport/storage)	+ 80 °C
Min. permitted ambient temp. for motor (transport/storage)	- 25 °C
Installation position	Any
Condensation drainage holes	None
Mode	S1
Motor bearing	Ball bearing
Technical features	- Reverse polarity protection
Electrical hookup	Plug
Motor protection	Reverse polarity and locked-rotor protection
Conformity with standards	EN 60950-1
Approval	UL 507; EAC

Product drawing

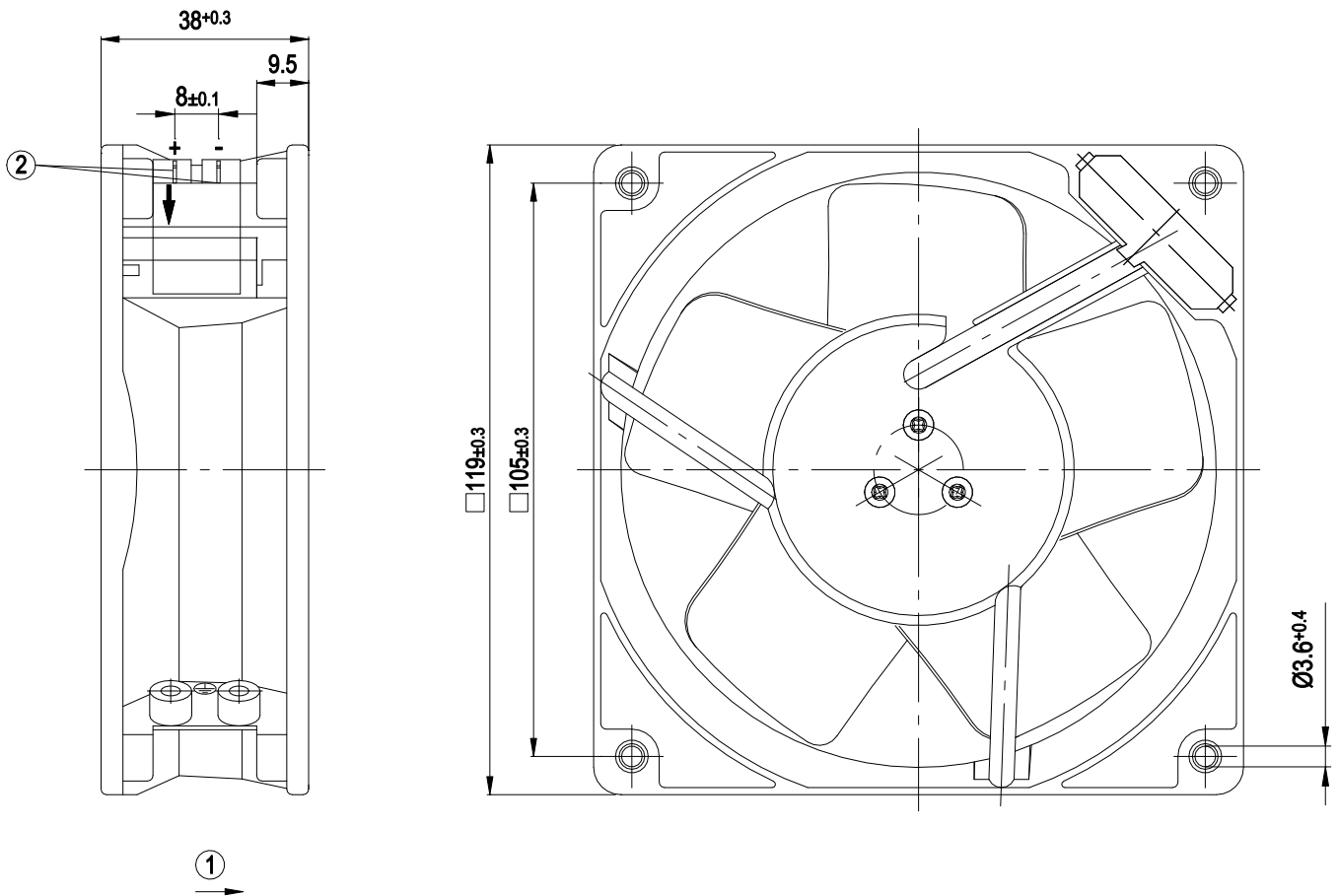

1	Direction of air flow "A"
2	2x flat plug 2.8 x 0.5 (AMP no. 170058-2)

Connection diagram

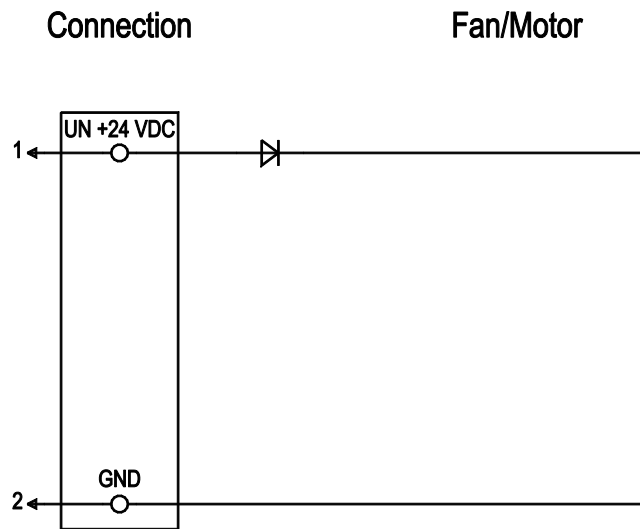

No.	Conn.	Designation	Color	Function/assignment
1		UN +24 VDC	red	Power supply 24 VDC, see nameplate for voltage range, maximum ripple $\pm 3.5\%$
2		GND	blue	Reference ground

Curves: Air performance

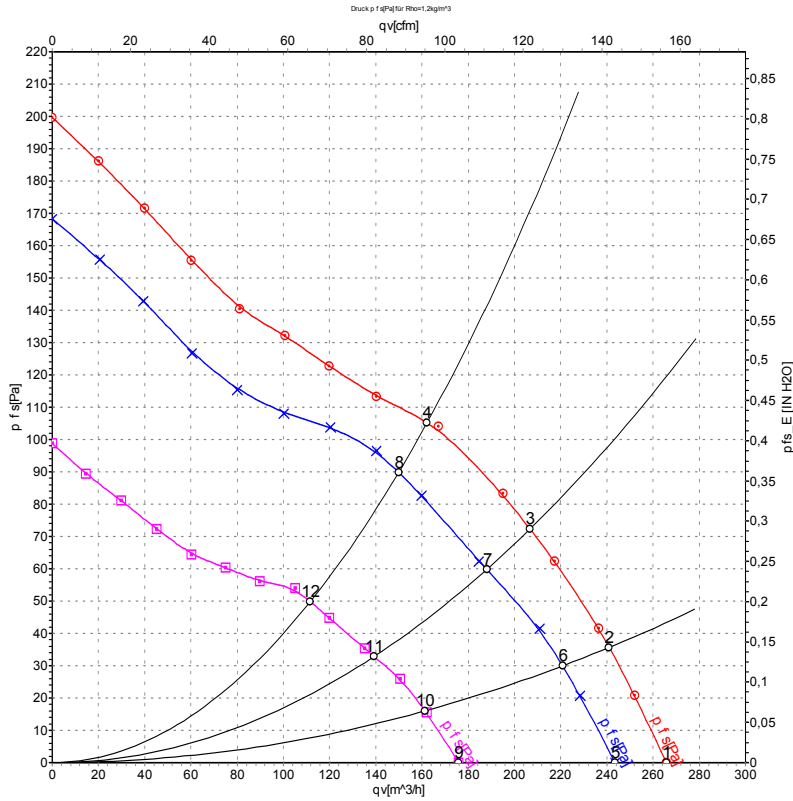

Measurement: LU-77463-1
 Measurement: LU-77462-1
 Measurement: LU-77464-1

Air performance measured according to ISO 5801 installation category A. For detailed information on the measurement setup, contact ebm-papst. Intake sound level: Sound power level according to ISO 13347 / sound pressure level measured at 1 m distance from fan axis. The values given are valid under the specified measuring conditions and may vary due to conditions of installation. For deviations from the standard configuration, the parameters have to be checked on the installed unit.

Measured values

	U	n	P _{ed}	I	q _v	p _{fs}	q _v	p _{fs}
	V	min ⁻¹	W	A	m ³ /h	Pa	cfm	in. wg
1	28	4755	21	0.83	265	0	155	0.00
2	28	4635	22	0.87	240	36	140	0.14
3	28	4485	23	0.90	205	72	120	0.29
4	28	4345	24	0.94	160	106	95	0.43
5	24	4400	15	0.62	245	0	145	0.00
6	24	4245	16	0.70	220	30	130	0.12
7	24	4110	17	0.75	190	60	110	0.24
8	24	3990	18	0.80	150	90	90	0.36
9	16	3230	6.3	0.41	175	0	105	0.00
10	16	3160	6.6	0.43	160	16	95	0.06
11	16	3075	6.9	0.45	140	33	80	0.13
12	16	2995	7.2	0.47	110	50	65	0.20

U = Voltage · n = Speed (rpm) · P_{ed} = Power consumption · I = Current draw · q_v = Air flow · p_{fs} = Pressure increase



Product Data Sheet

9294310138

VUC0119YUJBS

4184 NXH

ebmpapst

The engineer's choice



4184 NXH

INDEX

1 General 3

2 Mechanics 3

2.1 General..... 3

2.2 Connections..... 3

3 Operating Data 4

3.1 Electrical Operating Data 4

3.2 Electrical Features 5

3.3 Aerodynamics 6

3.4 Sound Data..... 7

4 Environment..... 7

4.1 General..... 7

4.2 Climatic Requirements 7

5 Safety..... 8

5.1 Electrical Safety 8

5.2 Approval Tests 8

6 Reliability..... 8

6.1 General..... 8

1 General

Fan type	Fan	
Rotating direction looking at rotor	Clockwise	
Airflow direction	Air intake over struts	
Bearing system	Ball bearing	
Mounting position - shaft	Any	

2 Mechanics**2.1 General**

Width	119,0 mm	
Height	119,0 mm	
Depth	38,0 mm	
Mass	0,380 kg	
Housing material	Metal	
Impeller material	Plastic	
Max. torque when mounted across both mounting flanges	Wire outlet corner: 170 Ncm Remaining corners: 300 Ncm	
Screw size	ISO 4762 - M3 degreased, without an additional brace and without washer	

2.2 Connections

Electrical connection	Plug	
Lead wire length	See drawing	
Tolerance		
Plug	See drawing	
Contact	See drawing	



3 Operating Data

3.1 Electrical Operating Data

Measurement conditions: Normal air density = 1,2 kg/m³; Temperature 23°C +/- 3°C; Motor axis horizontal; warm-up time before measuring 5 minutes (unless otherwise specified). In the intake and outlet area should not be any solid obstruction within 0,5 m.

$\Delta p = 0$: corresp. to free air flow (see chapter aerodynamics)
I: corresp. to arithm. mean current value

Features	Condition	Symbol	Values		
Voltage range		U	12 V		28 V
Nominal voltage		U _N		24 V	
Power consumption	$\Delta p = 0$	P	2,5 W	11 W	15,3 W
Tolerance	0010		+/- 17,5 %	+/- 12,5 %	+/- 15 %
Current consumption	$\Delta p = 0$	I	210 mA	460 mA	545 mA
Tolerance	0010		+/- 17,5 %	+/- 12,5 %	+/- 15 %
Speed	$\Delta p = 0$	n	2.500 1/min	4.400 1/min	4.750 1/min
Tolerance	0010		+/- 12,5 %	+/- 7,5 %	+/- 10 %
Starting current consumption				1.900 mA	

3.2 Electrical Features

Electronic function	None	
Reversed polarity protection	Rectifying diode	
Max. residual current at U_N	$I_F \leq 10 \text{ mA}$	
Locked rotor protection	Auto restart	
Locked rotor current at U_N	I_{block} approx. 1.900 mA	
Clock signal at locked rotor	t_3 / t_4 typical: 0,6 s / 10 s	

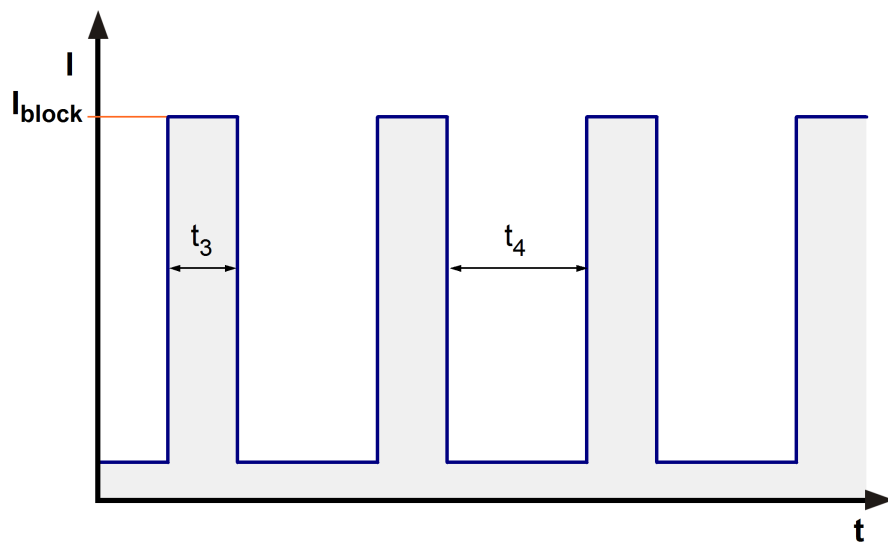

3.3 Aerodynamics

Measurement conditions: Measured with a double chamber intake rig acc. to DIN EN ISO 5801.
Normal air density = 1,2 kg/m³; Temperature 23°C +/- 3°C;
In the intake and outlet area should not be any solid obstruction within 0,5 m. Motor shaft horizontal.
The information is only valid under the specified test conditions and may be changed by the installation conditions. If there are deviations from the standard test conditions, the characteristic values must be checked under the installed conditions.

a.) Operation condition:

4.400 1/min at free air flow

Max. free-air flow ($\Delta p = 0 / \dot{V} = \text{max.}$)	227,0 m ³ /h	
Max. static pressure ($\Delta p = \text{max.} / \dot{V} = 0$)	180 Pa	

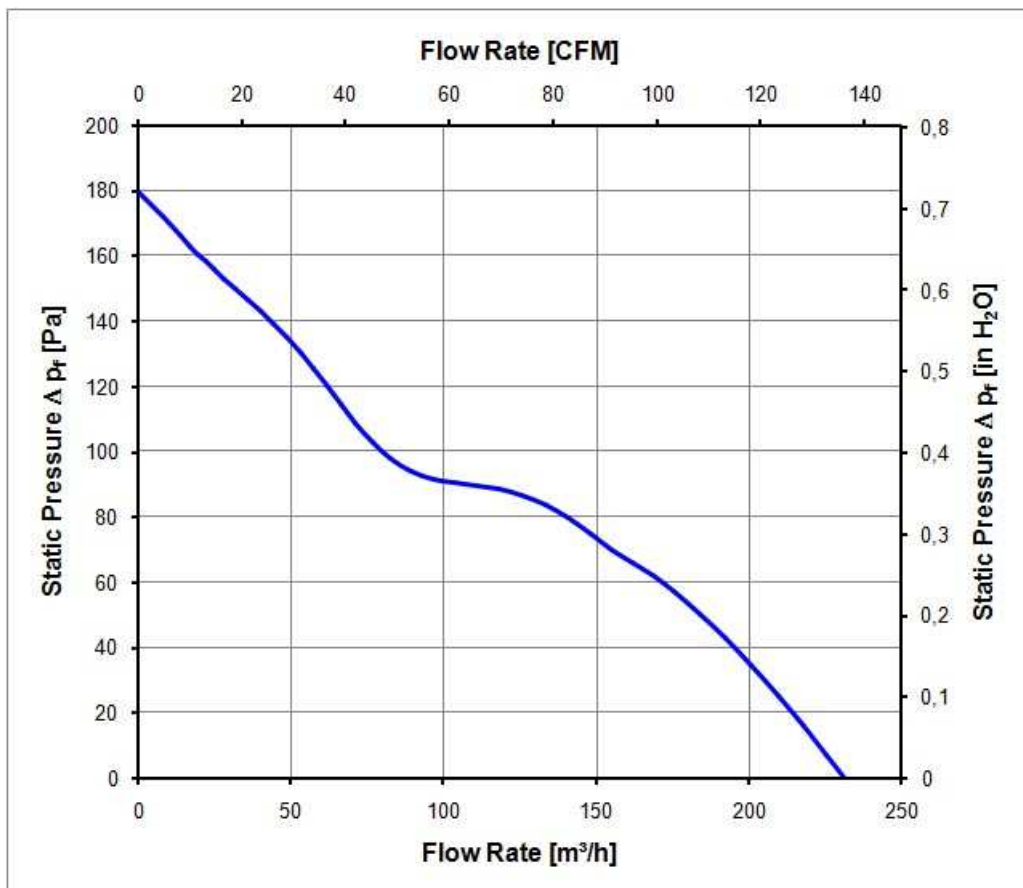

3.4 Sound Data

Measurement conditions: Sound pressure level: 1 meter distance between microphone and the air intake.
Sound power level: Acc. to DIN 45635 part 38 (ISO 10302)
Measured in a semianchoic chamber with a background noise level of $L_p(A) < 5 \text{ dB(A)}$
For further measurement conditions see chapter aerodynamics.

a.) Operation condition:

4.400 1/min at free air flow

Optimal operating point	130,0 m ³ /h @ 79 Pa	
Sound power level at the optimal operating point	6,2 bel(A)	
Sound pressure level at free air flow, measured in rubber bands	56,0 dB(A)	

4 Environment

4.1 General

Min. permitted ambient temperature TU min.	-30 °C	
Max. permitted ambient temperature TU max.	70 °C	
Min. permitted storage temperature TL min.	-40 °C	
Max. permitted storage temperature TL max.	80 °C	

4.2 Climatic Requirements

Humidity requirements	humid heat, constant; according to DIN EN 60068-2-78, 14 days	
Water exposure	None	
Dust requirements	None	
Salt fog requirements	None	

Permitted application area:

The product is intended for use in sheltered rooms with controlled temperature and controlled humidity. Directly exposure to water must be avoided.

Pollution degree 1 (according DIN EN 60664-1)

There is either no pollution or it occurs only dry, non-conductive pollution. The pollution has no negative impact.

Please require severity levels and specification parameters from the responsible development departments.

5 Safety

5.1 Electrical Safety

Dielectric strength DIN EN 60950 (VDE 0805) and DIN EN 60335 (VDE 0700) A.) Type test Measuring conditions: After 48h of storage at 95% R.H. and 25°C. No arcing or breakdown is allowed! All connections together to ground.	500 VAC / 1 Min.	
B.) Routine test Measuring conditions: At indoor climate. No arcing or breakdown is allowed! All connections together to ground.	850 VDC / 1 Sec.	
Isolation resistance Measuring conditions: After 48h of storage at 95% R.H. and 25°C measured with U=500 VDC for 1 min.	RI > 10 MOhm	
Clearance / creepage distance	1,0 mm / 1,2 mm	
Protection class	III	

5.2 Approval Tests

CE	EC Declaration of Conformity	Yes
EAC	Eurasian Conformity	Yes
UL	Underwriters Laboratories	Yes / UL507, Electric Fans E38324
VDE	Association for Electrical, Electronic and Information Technologies	Yes / Approval acc. to EN 60950 (VDE 0805) - Information technology equipment
CSA	Canadian Standards Association	Yes / C22.2 No. 113 Fans and Ventilators
CCC	China Compulsory Certification	Not applicable

6 Reliability

6.1 General

Life expectancy L10 at TU = 40 °C	70.000 h	
Life expectancy L10 at TU max.	35.000 h	
Life expectancy L10 acc. to IPC 9591 at TU = 40 °C	117.500 h	

Copying of this document, and giving it to others and the use or communication of the contents hereof, are forbidden without express authority. Offenders are liable to the payment of damages. All rights are reserved in the event of the grant of a patent or the registration of a utility model or design.

Schutzvermerk nach DIN ISO 16016 beachten/
Refer to protection notice DIN ISO 16016!

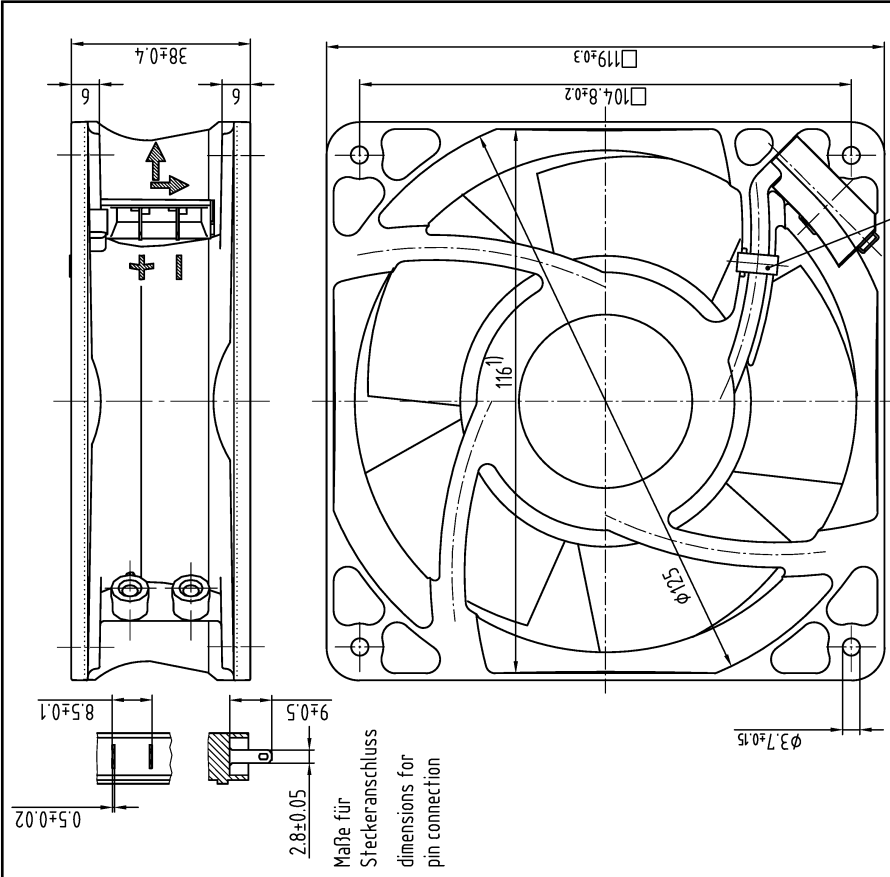

- 1) Maße für Montagewand
 2) wenn in Stückliste enthalten
- 1) dimensions for assembly wall
 2) only if included in bill of material
- Axialspiel bei
 - Kugellagerung (K): 0 (mit Federausgleich)
 - Gleitlagerung (G): 0.1 - 0.6
- axial clearance by
 - ball bearing (K): 0 (with spring compensation)
 - sleeve bearing (G): 0.1 - 0.6

SWP-Stab/Stüte	Änd.-Nr./Change-No.	 Tolerierung/Tolerances: Allgemeintoleranzen/Gen. tolerances	ebnpapst CAD-Unterstützung/ CAE-Entwurfsmittel Name/Name	Werkstoff/Material: Volumen/Volume (mm³): Gewicht/Mass (g):
Beinh./Drawn Gepr./Checked Freig./Released		Artikel/Title		Zeich.-Nr./Drawing-No.:
ebn-papst St. Georgen GmbH & Co. KG		Feldnummer/Type of Document		Ers. Zeich./Replaces:
ebmpapst		Feldname/Field/Pagel		Format/Size
ebn-papst St. Georgen GmbH & Co. KG		Material		Massstab/Scale

Product Data Sheet

9294310219

VUC0119YUJBS

4184 NXHR

ebmpapst

The engineer's choice



4184 NXHR

INDEX

1 General 3

2 Mechanics 3

2.1 General..... 3

2.2 Connections..... 3

3 Operating Data 4

3.1 Electrical Operating Data 4

3.2 Electrical Features 5

3.3 Aerodynamics 6

3.4 Sound Data..... 7

4 Environment..... 7

4.1 General..... 7

4.2 Climatic Requirements 7

5 Safety..... 8

5.1 Electrical Safety 8

5.2 Approval Tests 8

6 Reliability..... 8

6.1 General..... 8

1 General

Fan type	Fan	
Rotating direction looking at rotor	Clockwise	
Airflow direction	Air intake over struts	
Bearing system	Ball bearing	
Mounting position - shaft	Any	

2 Mechanics

2.1 General

Width	119,0 mm	
Height	119,0 mm	
Depth	38,0 mm	
Mass	0,380 kg	
Housing material	Metal	
Impeller material	Plastic	
Max. torque when mounted across both mounting flanges	Wire outlet corner: 170 Ncm Remaining corners: 300 Ncm	
Screw size	ISO 4762 - M3 degreased, without an additional brace and without washer	

2.2 Connections

Electrical connection	Plug	
Lead wire length	See drawing	
Tolerance		
Plug	See drawing	
Contact	See drawing	



3 Operating Data

3.1 Electrical Operating Data

Measurement conditions: Normal air density = 1,2 kg/m³; Temperature 23°C +/- 3°C; Motor axis horizontal; warm-up time before measuring 5 minutes (unless otherwise specified). In the intake and outlet area should not be any solid obstruction within 0,5 m.

$\Delta p = 0$: corresp. to free air flow (see chapter aerodynamics)
I: corresp. to arithm. mean current value

Features	Condition	Symbol	Values		
Voltage range		U	12 V		28 V
Nominal voltage		U _N		24 V	
Power consumption	$\Delta p = 0$	P	2,5 W	11 W	15,3 W
Tolerance	0010		+/- 17,5 %	+/- 12,5 %	+/- 15 %
Current consumption	$\Delta p = 0$	I	210 mA	460 mA	545 mA
Tolerance	0010		+/- 17,5 %	+/- 12,5 %	+/- 15 %
Speed	$\Delta p = 0$	n	2.500 1/min	4.400 1/min	4.750 1/min
Tolerance	0010		+/- 12,5 %	+/- 7,5 %	+/- 10 %
Starting current consumption				1.900 mA	

3.2 Electrical Features

Electronic function	None	
Reversed polarity protection	Rectifying diode	
Max. residual current at U_N	$I_F \leq 10 \text{ mA}$	
Locked rotor protection	Auto restart	
Locked rotor current at U_N	I_{block} approx. 1.900 mA	
Clock signal at locked rotor	t_3 / t_4 typical: 0,6 s / 10 s	

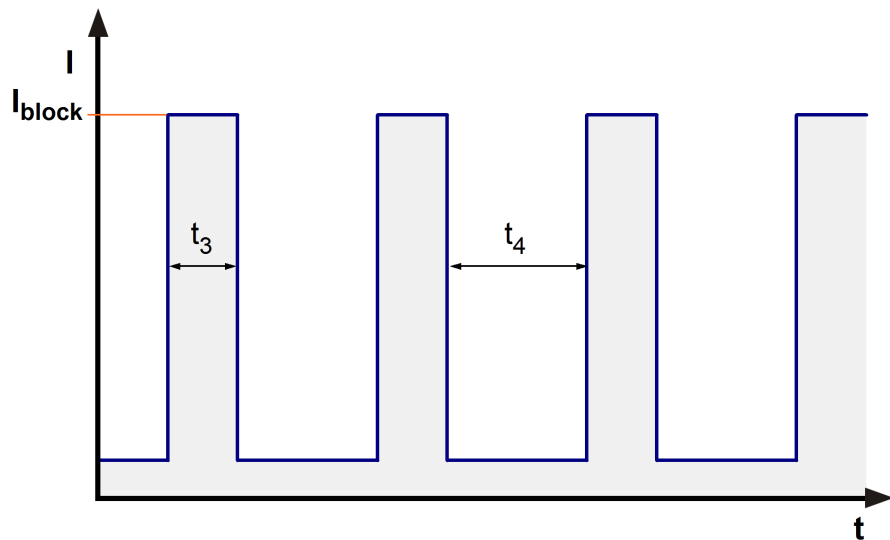

3.3 Aerodynamics

Measurement conditions: Measured with a double chamber intake rig acc. to DIN EN ISO 5801.
 Normal air density = 1,2 kg/m³; Temperature 23°C +/- 3°C;
 In the intake and outlet area should not be any solid obstruction within 0,5 m. Motor shaft horizontal.
 The information is only valid under the specified test conditions and may be changed by the installation conditions. If there are deviations from the standard test conditions, the characteristic values must be checked under the installed conditions.

a.) Operation condition:

4.400 1/min at free air flow

Max. free-air flow ($\Delta p = 0 / \dot{V} = \text{max.}$)	227,0 m ³ /h	
Max. static pressure ($\Delta p = \text{max.} / \dot{V} = 0$)	180 Pa	

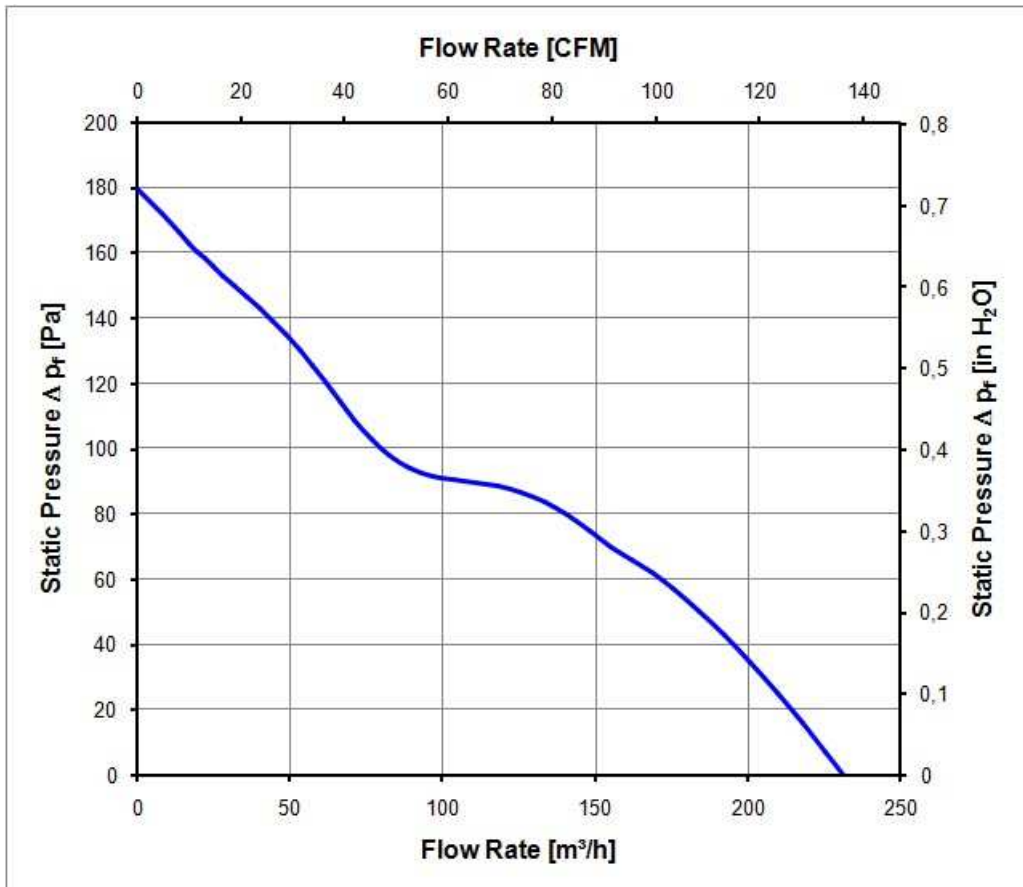

3.4 Sound Data

Measurement conditions: Sound pressure level: 1 meter distance between microphone and the air intake.
Sound power level: Acc. to DIN 45635 part 38 (ISO 10302)
Measured in a semianchoic chamber with a background noise level of $L_p(A) < 5 \text{ dB(A)}$
For further measurement conditions see chapter aerodynamics.

a.) Operation condition:

4.400 1/min at free air flow

Optimal operating point	130,0 m ³ /h @ 79 Pa	
Sound power level at the optimal operating point	6,2 bel(A)	
Sound pressure level at free air flow, measured in rubber bands	56,0 dB(A)	

4 Environment

4.1 General

Min. permitted ambient temperature TU min.	-30 °C	
Max. permitted ambient temperature TU max.	70 °C	
Min. permitted storage temperature TL min.	-40 °C	
Max. permitted storage temperature TL max.	80 °C	

4.2 Climatic Requirements

Humidity requirements	humid heat, cyclic; according to DIN EN 60068-2-30, 6 cycle	
Water exposure	None	
Dust requirements	Dust check; according to DIN EN 60068-2-68, 6g/m ² d, 1 day	
Salt fog requirements	None	

Permitted application area:

The product is for the use in sheltered rooms with limited controlled temperature. Occasionally condensed water is allowed. Direct exposure to water must be avoided. Saline ambient conditions must be avoided.

Pollution degree 2 (according DIN EN 60664-1)

It occurs only non-conductive pollution. Occasionally, temporary conductivity caused by condensation occurs.

Please require severity levels and specification parameters from the responsible development departments.

5 Safety

5.1 Electrical Safety

Dielectric strength DIN EN 60950 (VDE 0805) and DIN EN 60335 (VDE 0700) A.) Type test Measuring conditions: After 48h of storage at 95% R.H. and 25°C. No arcing or breakdown is allowed! All connections together to ground.	500 VAC / 1 Min.	
B.) Routine test Measuring conditions: At indoor climate. No arcing or breakdown is allowed! All connections together to ground.	850 VDC / 1 Sec.	
Isolation resistance Measuring conditions: After 48h of storage at 95% R.H. and 25°C measured with U=500 VDC for 1 min.	RI > 10 MOhm	
Clearance / creepage distance	1,0 mm / 1,2 mm	
Protection class	III	

5.2 Approval Tests

CE	EC Declaration of Conformity	Yes
EAC	Eurasian Conformity	Yes
UL	Underwriters Laboratories	Yes / UL507, Electric Fans E38324
VDE	Association for Electrical, Electronic and Information Technologies	Yes / Approval acc. to EN 60950 (VDE 0805) - Information technology equipment
CSA	Canadian Standards Association	Yes / C22.2 No. 113 Fans and Ventilators
CCC	China Compulsory Certification	Not applicable

6 Reliability

6.1 General

Life expectancy L10 at TU = 40 °C	70.000 h	
Life expectancy L10 at TU max.	35.000 h	
Life expectancy L10 acc. to IPC 9591 at TU = 40 °C	117.500 h	

Copying of this document, and giving it to others and the use or communication of the contents hereof, are forbidden without express authority. Offenders are liable to the payment of damages. All rights are reserved in the event of the grant of a patent or the registration of a utility model or design.

Schutzvermerk nach DIN ISO 16016 beachten!
Refer to protection notice DIN ISO 16016!

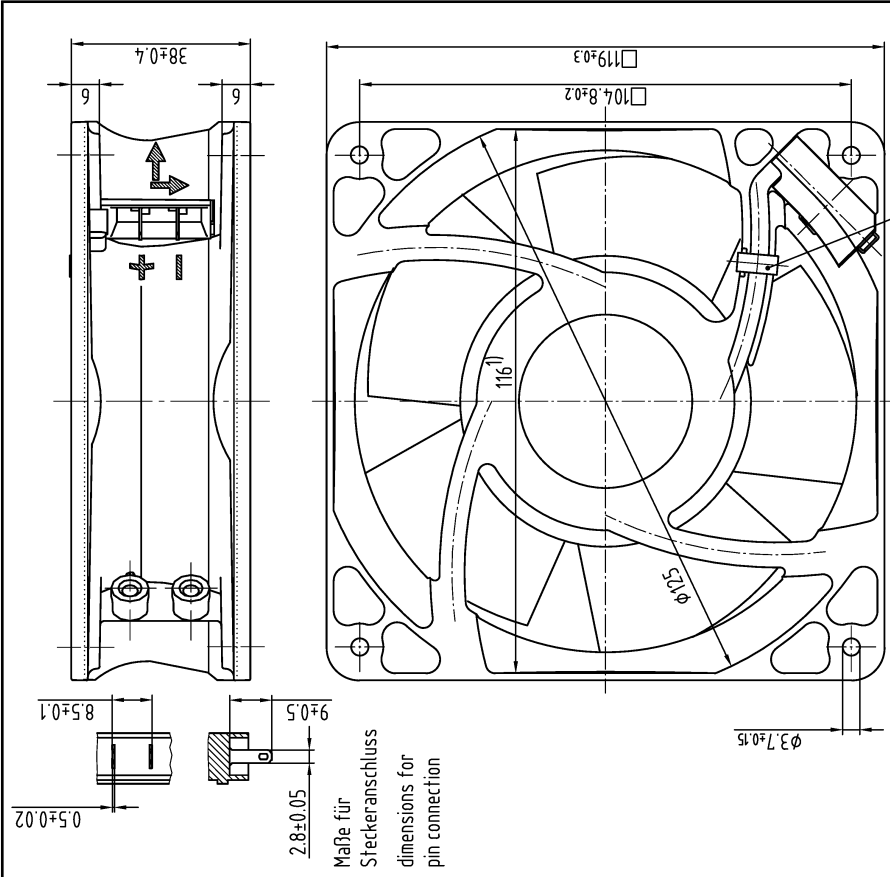

- 1) Maße für Montagewand
 2) wenn in Stückliste enthalten
- Axialspiel bei
 - Kugellagerung (K): 0 (mit Federausgleich)
 - Gleitlagerung (G): 0.1 - 0.6
- axial clearance by
 - ball bearing (K): 0 (with spring compensation)
 - sleeve bearing (G): 0.1 - 0.6

SWP-Stab/Stüte	Änd.-Nr./Change-No.	 Tolerierung/Tolerances: Allgemeintoleranzen/Gen. tolerances	ebmpapst <small>ebm-papst St. Georgen GmbH & Co. KG</small>		ebmpapst <small>ebm-papst St. Georgen GmbH & Co. KG</small>		Werkstoff/Material: Volumen/Volume (mm ³): Gewicht/Mass (g):
			AutoCAD-System-Version Datum/Date	CAD-Umgebung/ C.A.D. Environment Name/Name	Artikel/Title		

Product Data Sheet

9294310212

VUC0119YUJBZ

4114 NXHR

ebmpapst

The engineer's choice



4114 NXHR

INDEX

1 General 3

2 Mechanics 3

2.1 General..... 3

2.2 Connections..... 3

3 Operating Data 4

3.1 Electrical Operating Data 4

3.2 Electrical Features 5

3.3 Aerodynamics 6

3.4 Sound Data..... 7

4 Environment..... 7

4.1 General..... 7

4.2 Climatic Requirements 7

5 Safety..... 8

5.1 Electrical Safety 8

5.2 Approval Tests 8

6 Reliability..... 8

6.1 General..... 8

1 General

Fan type	Fan	
Rotating direction looking at rotor	Clockwise	
Airflow direction	Air intake over struts	
Bearing system	Ball bearing	
Mounting position - shaft	Any	

2 Mechanics

2.1 General

Width	119,0 mm	
Height	119,0 mm	
Depth	38,0 mm	
Mass	0,380 kg	
Housing material	Metal	
Impeller material	Plastic	
Max. torque when mounted across both mounting flanges	Wire outlet corner: 170 Ncm Remaining corners: 300 Ncm	
Screw size	ISO 4762 - M3 degreased, without an additional brace and without washer	

2.2 Connections

Electrical connection	Wires	
Lead wire length	L = 310 mm	
Tolerance	+/- 10,0 mm	

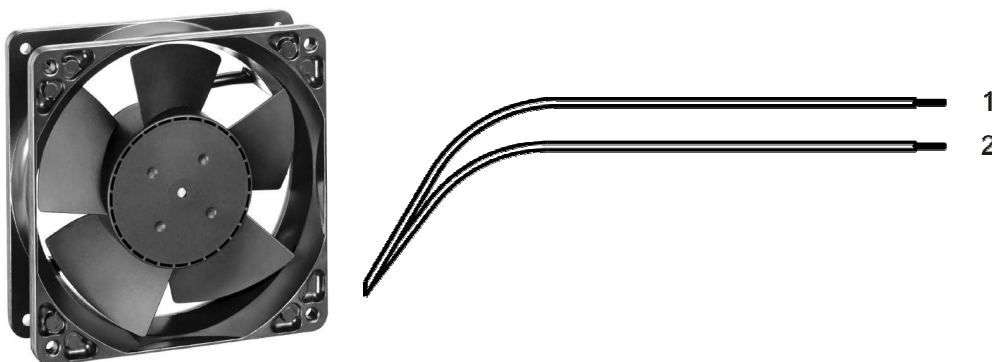

Wire	Color	Operation	Wire size	Insulation diameter
1	red	+ UB	AWG 22	1,7 mm
2	blue	- GND	AWG 22	1,7 mm

3 Operating Data

3.1 Electrical Operating Data

Measurement conditions: Normal air density = 1,2 kg/m³; Temperature 23°C +/- 3°C; Motor axis horizontal; warm-up time before measuring 5 minutes (unless otherwise specified). In the intake and outlet area should not be any solid obstruction within 0,5 m.

$\Delta p = 0$: corresp. to free air flow (see chapter aerodynamics)
I: corresp. to arithm. mean current value

Features	Condition	Symbol	Values		
Voltage range		U	12 V		28 V
Nominal voltage		U _N		24 V	
Power consumption	$\Delta p = 0$	P	2,5 W	11 W	15,3 W
Tolerance	0010		+/- 17,5 %	+/- 12,5 %	+/- 15 %
Current consumption	$\Delta p = 0$	I	210 mA	460 mA	545 mA
Tolerance	0010		+/- 17,5 %	+/- 12,5 %	+/- 15 %
Speed	$\Delta p = 0$	n	2.500 1/min	4.400 1/min	4.750 1/min
Tolerance	0010		+/- 12,5 %	+/- 7,5 %	+/- 10 %
Starting current consumption				1.900 mA	

3.2 Electrical Features

Electronic function	None	
Reversed polarity protection	Rectifying diode	
Max. residual current at U_N	$I_F \leq 10 \text{ mA}$	
Locked rotor protection	Auto restart	
Locked rotor current at U_N	I_{block} approx. 1.900 mA	
Clock signal at locked rotor	t_3 / t_4 typical: 0,6 s / 10 s	

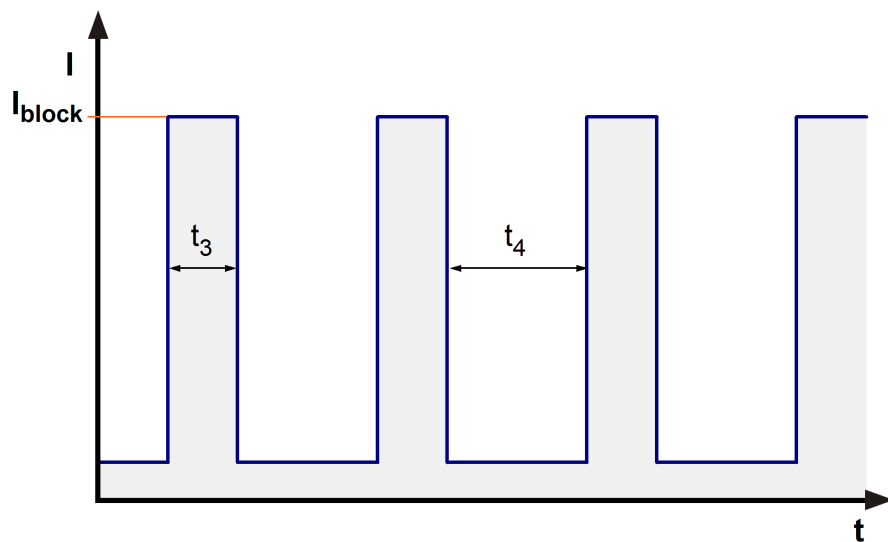

3.3 Aerodynamics

Measurement conditions: Measured with a double chamber intake rig acc. to DIN EN ISO 5801.
Normal air density = 1,2 kg/m³; Temperature 23°C +/- 3°C;
In the intake and outlet area should not be any solid obstruction within 0,5 m. Motor shaft horizontal.
The information is only valid under the specified test conditions and may be changed by the installation conditions. If there are deviations from the standard test conditions, the characteristic values must be checked under the installed conditions.

a.) Operation condition:

4.400 1/min at free air flow

Max. free-air flow ($\Delta p = 0 / \dot{V} = \text{max.}$)	227,0 m ³ /h	
Max. static pressure ($\Delta p = \text{max.} / \dot{V} = 0$)	180 Pa	

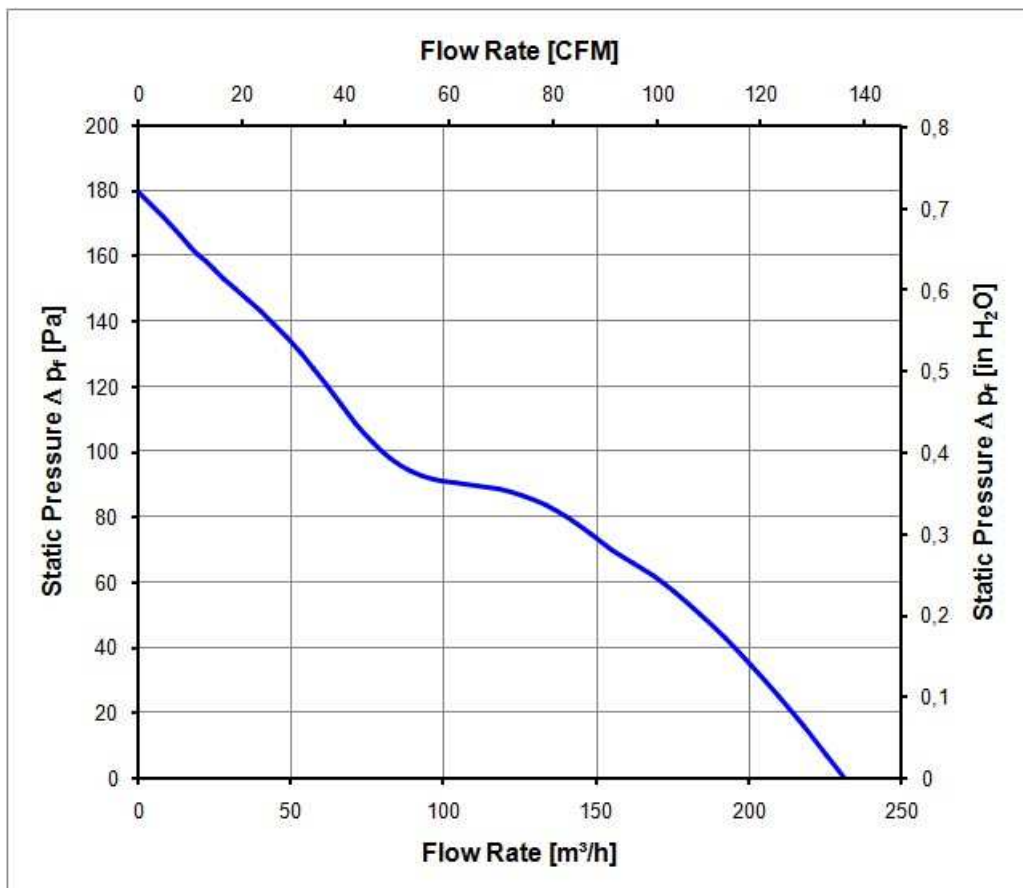

3.4 Sound Data

Measurement conditions: Sound pressure level: 1 meter distance between microphone and the air intake.
Sound power level: Acc. to DIN 45635 part 38 (ISO 10302)
Measured in a semianchoic chamber with a background noise level of $L_p(A) < 5 \text{ dB(A)}$
For further measurement conditions see chapter aerodynamics.

a.) Operation condition:

4.400 1/min at free air flow		
Optimal operating point	130,0 m ³ /h @ 79 Pa	
Sound power level at the optimal operating point	6,2 bel(A)	
Sound pressure level at free air flow, measured in rubber bands	56,0 dB(A)	

4 Environment

4.1 General

Min. permitted ambient temperature TU min.	-30 °C	
Max. permitted ambient temperature TU max.	70 °C	
Min. permitted storage temperature TL min.	-40 °C	
Max. permitted storage temperature TL max.	80 °C	

4.2 Climatic Requirements

Humidity requirements	humid heat, cyclic; according to DIN EN 60068-2-30, 6 cycle	
Water exposure	None	
Dust requirements	Dust check; according to DIN EN 60068-2-68, 6g/m ² d, 1 day	
Salt fog requirements	None	

Permitted application area:

The product is for the use in sheltered rooms with limited controlled temperature. Occasionally condensed water is allowed. Direct exposure to water must be avoided. Saline ambient conditions must be avoided.

Pollution degree 2 (according DIN EN 60664-1)

It occurs only non-conductive pollution. Occasionally, temporary conductivity caused by condensation occurs.

Please require severity levels and specification parameters from the responsible development departments.

5 Safety

5.1 Electrical Safety

Dielectric strength DIN EN 60950 (VDE 0805) and DIN EN 60335 (VDE 0700) A.) Type test Measuring conditions: After 48h of storage at 95% R.H. and 25°C. No arcing or breakdown is allowed! All connections together to ground.	500 VAC / 1 Min.	
B.) Routine test Measuring conditions: At indoor climate. No arcing or breakdown is allowed! All connections together to ground.	850 VDC / 1 Sec.	
Isolation resistance Measuring conditions: After 48h of storage at 95% R.H. and 25°C measured with U=500 VDC for 1 min.	RI > 10 MOhm	
Clearance / creepage distance	1,0 mm / 1,2 mm	
Protection class	III	

5.2 Approval Tests

CE	EC Declaration of Conformity	Yes
EAC	Eurasian Conformity	Yes
UL	Underwriters Laboratories	Yes / UL507, Electric Fans E38324
VDE	Association for Electrical, Electronic and Information Technologies	Yes / Approval acc. to EN 60950 (VDE 0805) - Information technology equipment
CSA	Canadian Standards Association	Yes / C22.2 No. 113 Fans and Ventilators
CCC	China Compulsory Certification	Not applicable

6 Reliability

6.1 General

Life expectancy L10 at TU = 40 °C	70.000 h	
Life expectancy L10 at TU max.	35.000 h	
Life expectancy L10 acc. to IPC 9591 at TU = 40 °C	117.500 h	

Copying of this document, and giving it to others and the use or communication of the contents thereof, are forbidden without express authority. Offenders are liable to the payment of damages. All rights are reserved in the event of the grant of a patent or the registration of a utility model or design.

Schutzvermerk nach DIN ISO 16016 beachten/
Refer to protection notice DIN ISO 16016!

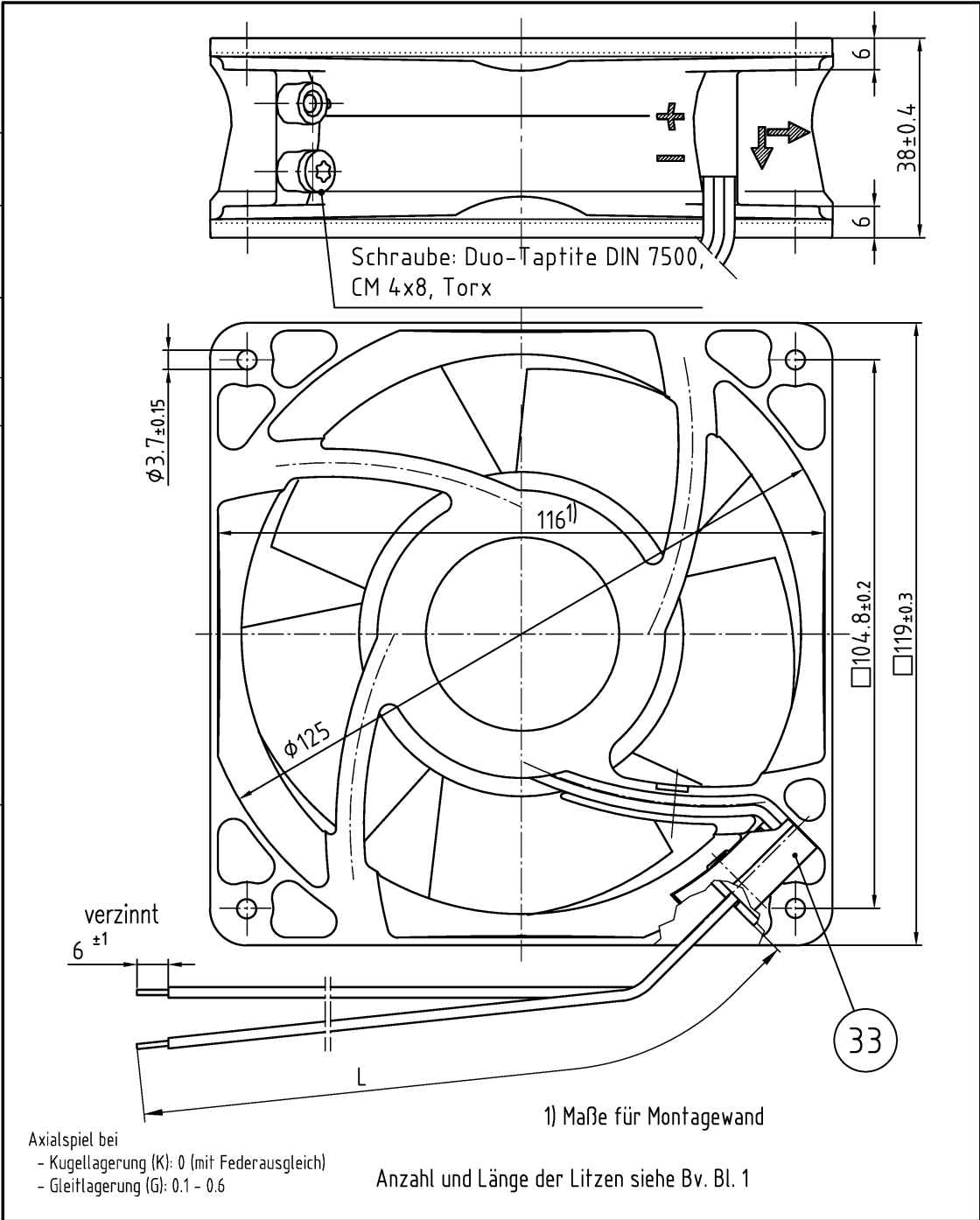

Tolerierung/Tolerances: DIN 7167		Längenmaße: DIN ISO 2768-cL		Artikel/Title		Massstab/scale	
Allgemeintoleranzen/ Gen. tolerances: DIN 7167		Winkel, Form u. Lage: DIN ISO 2768-cL					
Datum/Date		Name/Name				Zchg.-Nr./ Dwg.-No.:	
Bearb./Drawn:							
Index/Index		Aend.-Nr./Change-No.		ebmpapst		Blatt/Page	
gepr. u. zur Verwendung freigegeben/Checked for release von am by		ebm-papst St. Georgen GmbH & Co. KG					
				Ers.f.Zchg./ Replaces:		A4	

ebm-papst Mulfingen GmbH & Co. KG

Bachmühle 2 · D-74673 Mulfingen

Phone +49 7938 81-0

Fax +49 7938 81-110

info1@de.ebmpapst.com

www.ebmpapst.com

Limited partnership · Headquarters Mulfingen

Amtsgericht (court of registration) Stuttgart · HRA 590344

General partner Elektrobau Mulfingen GmbH · Headquarters Mulfingen

Amtsgericht (court of registration) Stuttgart · HRB 590142

Nominal data

Type	W2G115-AG71-12	
Motor	M2G045-BA	
Nominal voltage	VDC	24
Nominal voltage range	VDC	16 .. 28
Method of obtaining data		fa
Status		prelim.
Speed (rpm)	min ⁻¹	4050
Power consumption	W	12
Min. ambient temperature	°C	-25
Max. ambient temperature	°C	72

ml = Max. load · me = Max. efficiency · fa = Free air · cs = Customer specification · ce = Customer equipment
Subject to change

Technical description

Weight	0.55 kg
Size	115 mm
Motor size	45
Rotor surface	Painted black
Blade material	Sheet steel, painted black
Fan housing material	Die-cast aluminum, painted black
Number of blades	7
Airflow direction	V
Direction of rotation	Counterclockwise, viewed toward rotor
Degree of protection	IP22
Insulation class	"B"
Moisture (F) / Environmental (H) protection class	H1
Max. permitted ambient temp. for motor (transport/storage)	+ 80 °C
Min. permitted ambient temp. for motor (transport/storage)	- 40 °C
Installation position	Any
Condensation drainage holes	On rotor side
Mode	S1
Motor bearing	Ball bearing
Technical features	- Reverse polarity protection
Electrical hookup	Plug
Motor protection	Reverse polarity and locked-rotor protection

EC axial compact fan

straight blades (A series)

Product drawing

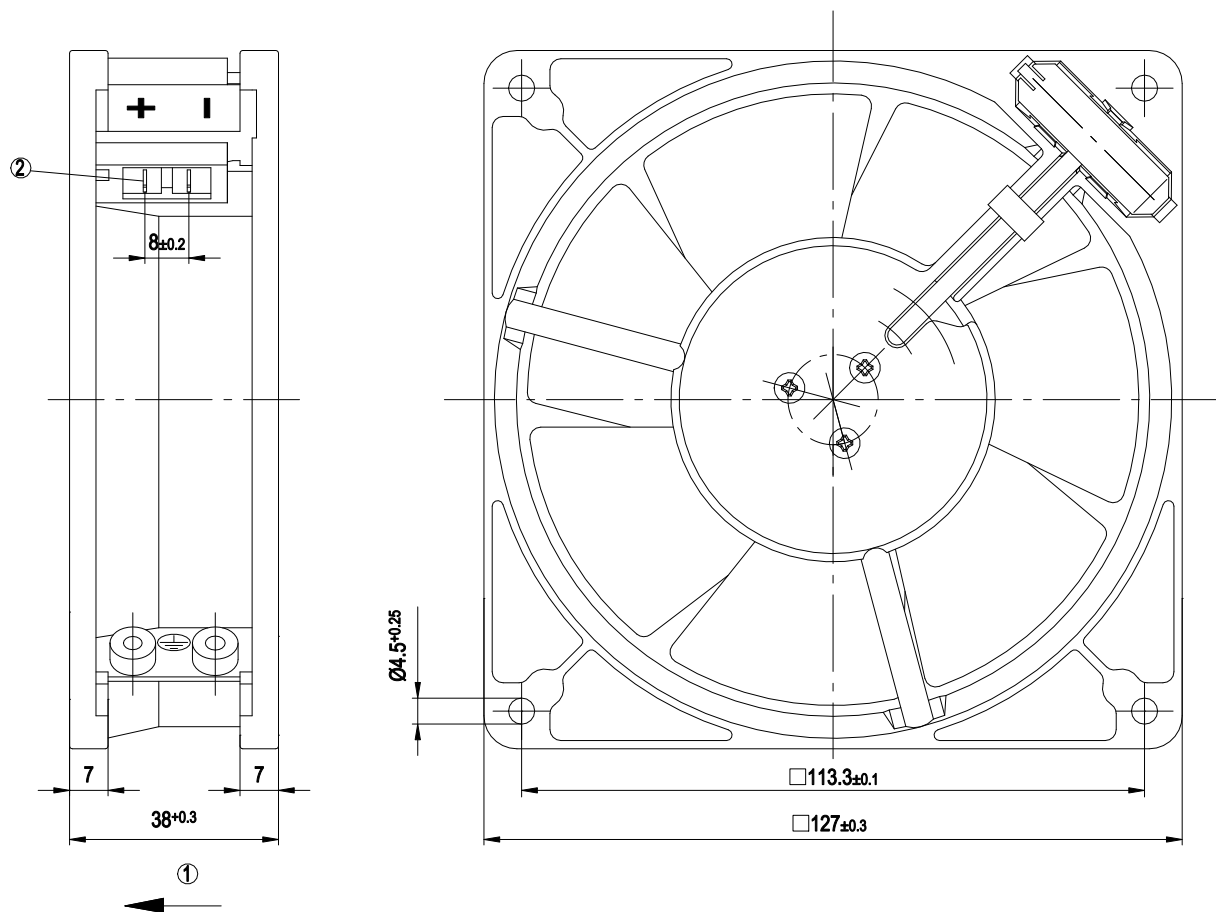

- | | |
|---|---|
| 1 | Direction of air flow "V" |
| 2 | 2x flat plug 2.8 x 0.5 (AMP no. 170058-2) |

Connection diagram

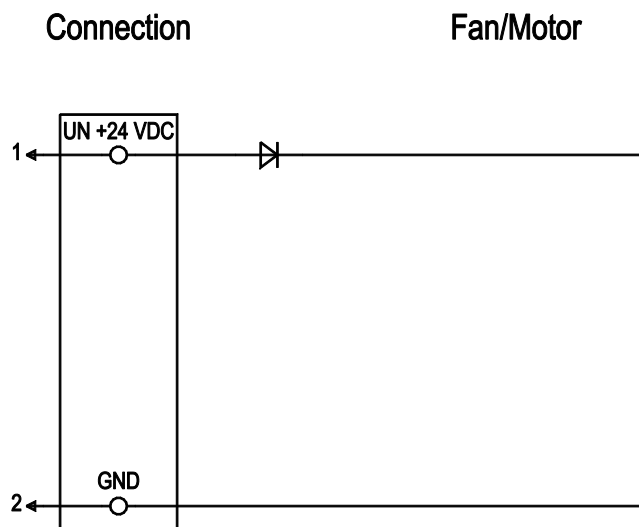

No.	Conn.	Designation	Color	Function/assignment
1		UN +24 VDC	red	Power supply 24 VDC, see nameplate for voltage range, maximum ripple $\pm 3.5\%$
2		GND	blue	Reference ground

Curves: Air performance

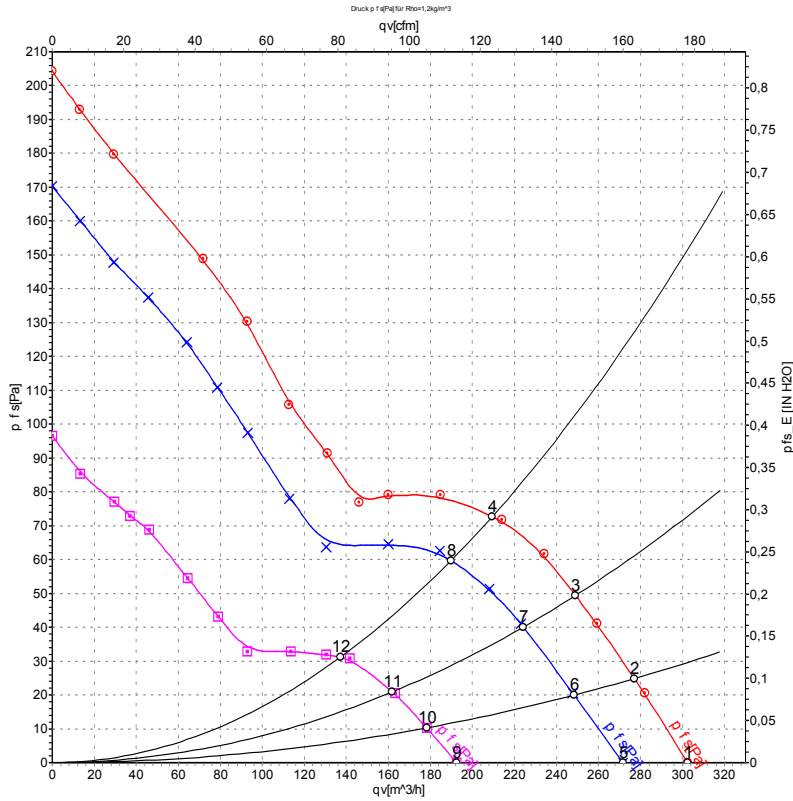

Measurement: LU-17909-1
 Measurement: LU-17908-1
 Measurement: LU-17910-1

Air performance measured according to ISO 5801 installation category A. For detailed information on the measurement setup, contact ebm-papst. Intake sound level: Sound power level according to ISO 13347 / sound pressure level measured at 1 m distance from fan axis. The values given are valid under the specified measuring conditions and may vary due to conditions of installation. For deviations from the standard configuration, the parameters have to be checked on the installed unit.

Measured values

	U	n	P _{ed}	I	q _v	p _{fs}	q _v	p _{fs}
	V	min ⁻¹	W	A	m ³ /h	Pa	cfm	in. wg
1	28	4490	17	0.60	300	0	180	0.00
2	28	4370	17	0.60	275	25	165	0.10
3	28	4245	19	0.66	250	49	145	0.20
4	28	4150	17	0.59	210	73	125	0.29
5	24	4050	12	0.51	270	0	160	0.00
6	24	3955	12	0.52	250	20	145	0.08
7	24	3855	14	0.56	225	40	130	0.16
8	24	3750	14	0.58	190	60	110	0.24
9	16	2930	4.3	0.27	195	0	115	0.00
10	16	2860	5.0	0.31	180	10	105	0.04
11	16	2800	4.6	0.29	160	21	95	0.08
12	16	2750	5.4	0.34	135	31	80	0.12

U = Voltage · n = Speed (rpm) · P_{ed} = Power consumption · I = Current draw · q_v = Air flow · p_{fs} = Pressure increase



Product Data Sheet

9694320201

VWC0127YUJBS

5214 NHH

ebmpapst

The engineer's choice



5214 NHH

INDEX

1 General 3

2 Mechanics 3

2.1 General..... 3

2.2 Connections..... 3

3 Operating Data 4

3.1 Electrical Operating Data 4

3.2 Electrical Features 5

3.3 Aerodynamics 6

3.4 Sound Data..... 7

4 Environment..... 7

4.1 General..... 7

4.2 Climatic Requirements 7

5 Safety..... 8

5.1 Electrical Safety 8

5.2 Approval Tests 8

6 Reliability..... 8

6.1 General..... 8

1 General

Fan type	Fan	
Rotating direction looking at rotor	Counterclockwise	
Airflow direction	Air outlet over struts	
Bearing system	Ball bearing	
Mounting position - shaft	Any	

2 Mechanics

2.1 General

Width	127,0 mm	
Height	127,0 mm	
Depth	38,0 mm	
Mass	0,315 kg	
Housing material	Plastic	
Impeller material	Plastic	
Max. torque when mounted across both mounting flanges	Wire outlet corner: 10 Ncm Remaining corners: 60 Ncm	
Screw size	ISO 4762 - M4 degreased, without an additional brace and without washer	

2.2 Connections

Electrical connection	Wires	
Lead wire length	L = 310 mm	
Tolerance	+/- 10,0 mm	
Wire size (AWG)	22	
Insulation diameter	1,70 mm	

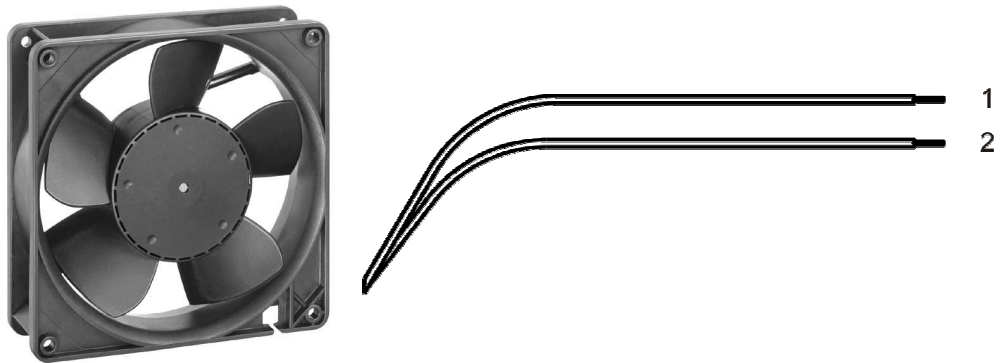

Wire	Color	Operation
1	red	+ UB
2	blue	- GND

3 Operating Data

3.1 Electrical Operating Data

Measurement conditions: Normal air density = 1,2 kg/m³; Temperature 23°C +/- 3°C; Motor axis horizontal; warm-up time before measuring 5 minutes (unless otherwise specified). In the intake and outlet area should not be any solid obstruction within 0,5 m.

$\Delta p = 0$: corresp. to free air flow (see chapter aerodynamics)
I: corresp. to arithm. mean current value

Note:**No inrush current at Unom means:**

The internal electrolytic capacitor 120uF/50V has no resistor or inrush current limitation, essentially the power supply and the type and length of the connecting cable is limiting the Inrush current.

Features	Condition	Symbol	Values		
Voltage range		U	16 V		30,0 V
Nominal voltage		U _N		24,0 V	
Power consumption	$\Delta p = 0$	P	9,6 W	17,5 W	19,5 W
Tolerance	0010		+/- 15 %	+/- 15,0 %	+/- 15,0 %
Current consumption	$\Delta p = 0$	I	600 mA	730 mA	650 mA
Tolerance	0010		+/- 15,0 %	+/- 15,0 %	+/- 15,0 %
Speed	$\Delta p = 0$	n	3.800 1/min	4.900 1/min	4.900 1/min
Tolerance	0010		+/- 10,0 %	+/- 10,0 %	+/- 10,0 %
Starting current consumption				3.300 mA	

3.2 Electrical Features

Electronic function	Speed-Controlled	
Reversed polarity protection	Rectifying diode	
Max. residual current at U_N	$I_F \leq 10 \text{ mA}$	
Locked rotor protection	Auto restart	
Locked rotor current at U_N	I_{block} approx. 3.300 mA	
Clock signal at locked rotor	t_3 / t_4 typical: 1,2 s / 5,0 s	

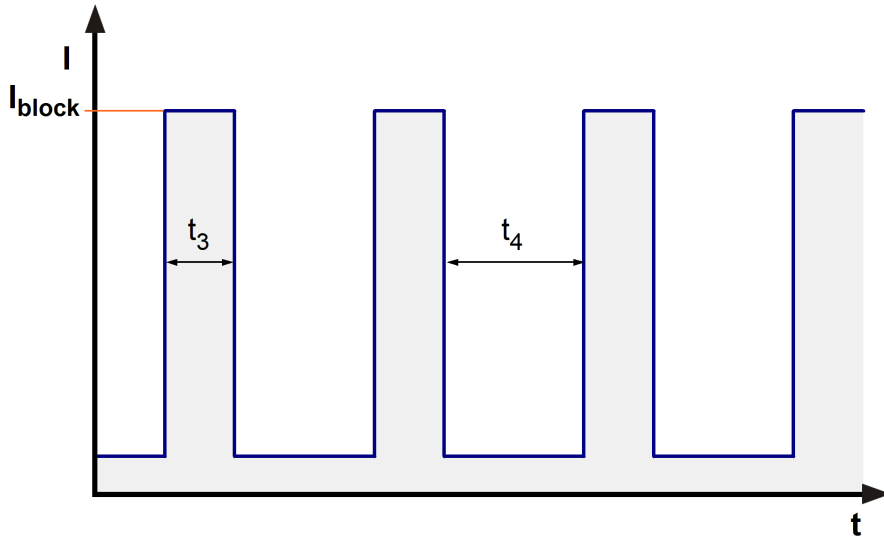

Internal Fuse:

Littlefuse NANO2(R) FUSE; Very fast acting 451 Series; 3 A (Art.-Nr.: 451003)

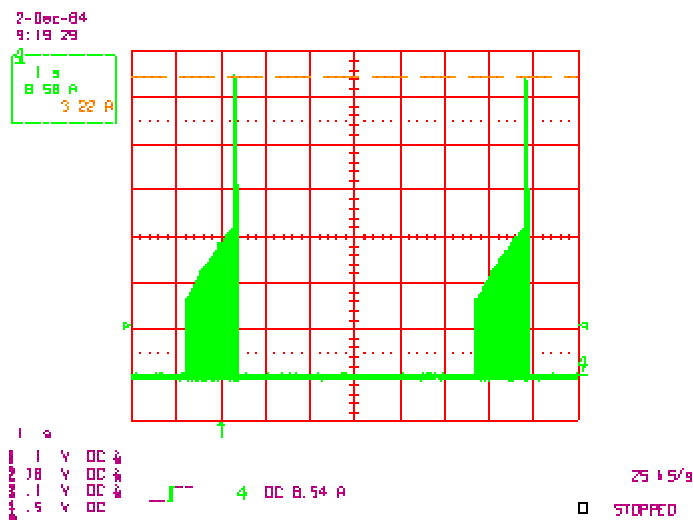

3.3 Aerodynamics

Measurement conditions: Measured with a double chamber intake rig acc. to DIN EN ISO 5801. Normal air density = 1,2 kg/m³; Temperature 23°C +/- 3°C; In the intake and outlet area should not be any solid obstruction within 0,5 m. Motor shaft horizontal. The information is only valid under the specified test conditions and may be changed by the installation conditions. If there are deviations from the standard test conditions, the characteristic values must be checked under the installed conditions. Power consumption of the fan motor when operating at normal voltage is shown. Depending on the operating conditions of the application, the power input may be higher.

a.) Operation condition:

4.900 1/min at free air flow		
Max. free-air flow ($\Delta p = 0 / \dot{V} = \text{max.}$)	340,0 m ³ /h	
Max. static pressure ($\Delta p = \text{max.} / \dot{V} = 0$)	215 Pa	

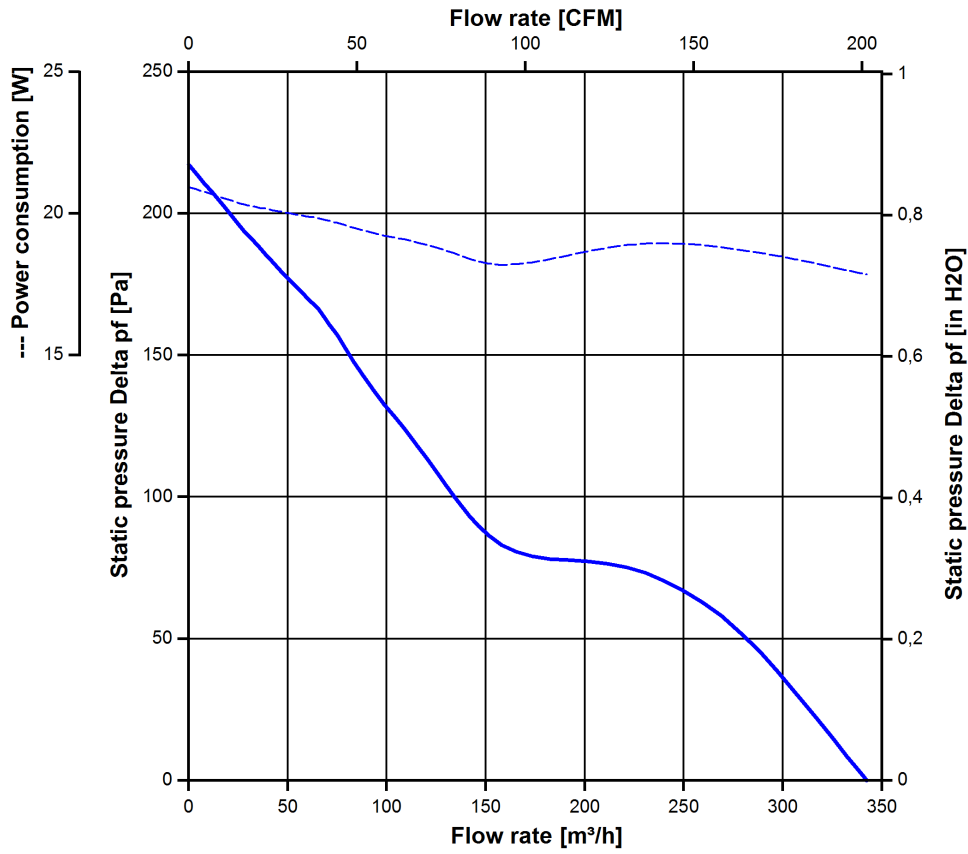

3.4 Sound Data

Measurement conditions: Sound pressure level: 1 meter distance between microphone and the air intake.
Sound power level: Acc. to DIN 45635 part 38 (ISO 10302)
Measured in a semianchoic chamber with a background noise level of $L_p(A) < 5 \text{ dB(A)}$
For further measurement conditions see chapter aerodynamics.

a.) Operation condition:

4.900 1/min at free air flow		
Optimal operating point	210 m ³ /h @ 76 Pa	
Sound power level at the optimal operating point	6,6 bel(A)	
Sound pressure level at free air flow, measured in rubber bands	58,0 dB(A)	

4 Environment

4.1 General

Min. permitted ambient temperature TU min.	-20 °C	
Max. permitted ambient temperature TU max.	65 °C	
Min. permitted storage temperature TL min.	-40 °C	
Max. permitted storage temperature TL max.	80 °C	

4.2 Climatic Requirements

Humidity requirements	humid heat, constant; according to DIN EN 60068-2-78, 14 days	
Water exposure	None	
Dust requirements	None	
Salt fog requirements	None	

Permitted application area:

The product is intended for use in sheltered rooms with controlled temperature and controlled humidity. Directly exposure to water must be avoided.

Pollution degree 1 (according DIN EN 60664-1)

There is either no pollution or it occurs only dry, non-conductive pollution. The pollution has no negative impact.

Please require severity levels and specification parameters from the responsible development departments.

5 Safety**5.1 Electrical Safety**

Dielectric strength DIN EN 60950 (VDE 0805) and DIN EN 60335 (VDE 0700) A.) Type test Measuring conditions: After 48h of storage at 95% R.H. and 25°C. No arcing or breakdown is allowed! All connections together to ground.	500 VAC / 1 Min.	
B.) Routine test Measuring conditions: At indoor climate. No arcing or breakdown is allowed! All connections together to ground.	850 VDC / 1 Sec.	
Isolation resistance Measuring conditions: After 48h of storage at 95% R.H. and 25°C measured with U=500 VDC for 1 min.	RI > 10 MOhm	
Clearance / creepage distance	1,0 mm / 1,2 mm	
Protection class	III	

5.2 Approval Tests

CE	EC Declaration of Conformity	Yes
EAC	Eurasian Conformity	Yes
UL	Underwriters Laboratories	Yes / UL507, Electric Fans E38324
VDE	Association for Electrical, Electronic and Information Technologies	Yes / Approval acc. to EN 60950 (VDE 0805) - Information technology equipment
CSA	Canadian Standards Association	Yes / C22.2 No. 113 Fans and Ventilators
CCC	China Compulsory Certification	Not applicable

The approval tests are observed to:

U approval max.:30,0 V @ TU approval max.: 65,0 °C

6 Reliability**6.1 General**

Life expectancy L10 at TU = 40 °C	45.000 h	
Life expectancy L10 at TU max.	25.000 h	
Life expectancy L10 acc. to IPC 9591 at TU = 40 °C	75.0 00 h	

Copying of this document, and giving it to others and the use or communication of the contents thereof, are forbidden without express authority. Offenders are liable to the payment of damages. All rights are reserved in the event of the grant of a patent or the registration of a utility model or design.

Schutzmerk nach DIN ISO 16016 beachten/
Refer to protection notice DIN ISO 16016

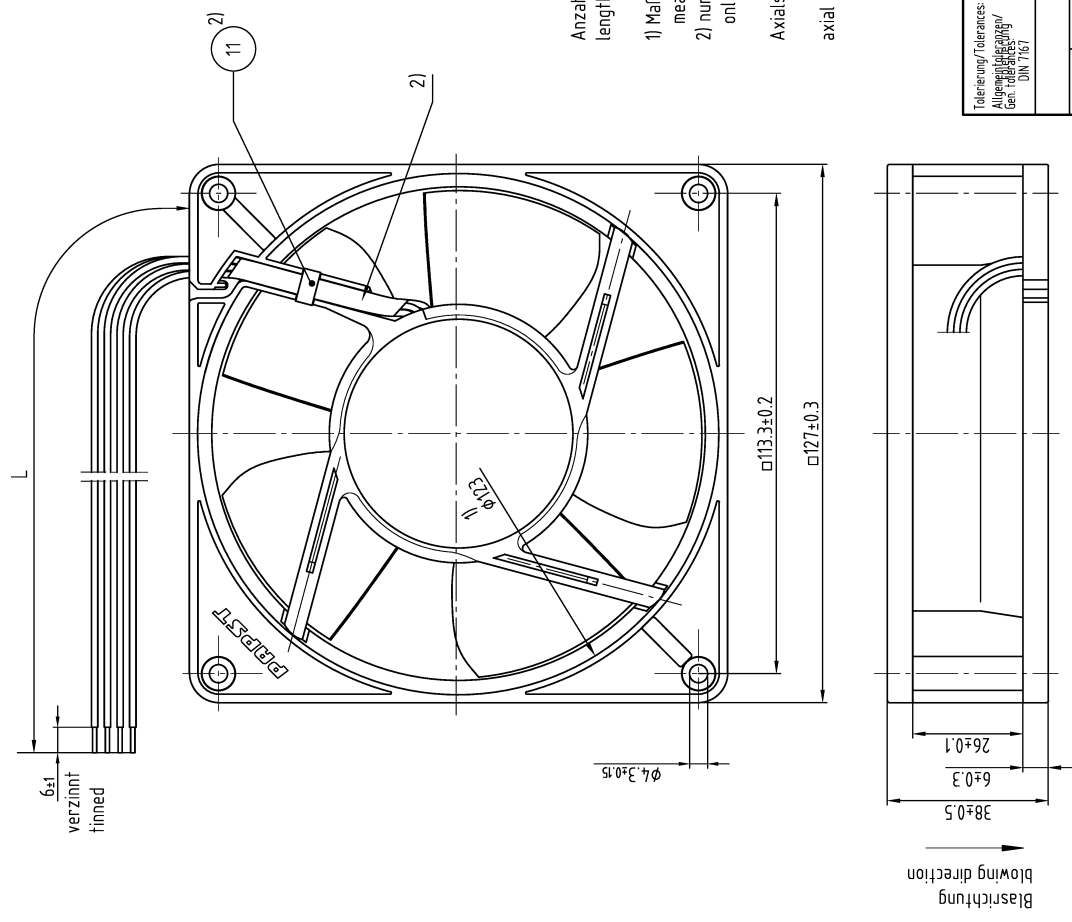

Anzahl und Länge der Litzen siehe BV-Blatt 1
length and number of wires see design specifications page 1

- 1) Maße für Montagewand
measures for mounting plate
- 2) nur, wenn in Stückliste angegeben
only, if included in bill of material

Axialspiel bei Kugellagerung mit Feder spielfrei verspannt
bei Gleitlagerung 0,1 – 0,6 mm
axial tolerance by ball bearing without axial clearance by a preloaded spring
by sleeve bearing 0,1 – 0,6 mm

Tolerierung/Tolerances: Allgemein/General/ gem. DIN 7167 DIN 7167		DIN 7167 Längenmaße: Winkel, Form u. Lage - DIN ISO 2768-mK		Arzteil/ Title	Massstab/Scale
Bezeichnung/Designation	Name/Name	Name/Name		Zichte-Nr./ Dwg.-No.:	Blatt/Page
Datum/Date	Arzt/Arzt	Arzt/Arzt			
Verwendet/Used for release		Verwendet/Used for release		Ers. Zichte/ Replaces:	A3
Verf. u. zur Verwendung freigegeben/Released for release		Verf. u. zur Verwendung freigegeben/Released for release		ebs-papst St. Georgen GmbH & Co. KG	

Product Data Sheet

9294310809
VKC0127AUJBZ
DV5214NU

ebmpapst

The engineer's choice



DV5214NU

INDEX

1 General 3

2 Mechanics 3

2.1 General..... 3

2.2 Connections..... 3

3 Operating Data 4

3.1 Electrical Operating Data 4

3.2 Electrical Features 5

3.3 Aerodynamics 7

3.4 Sound Data..... 8

4 Environment..... 8

4.1 General..... 8

4.2 Climatic Requirements 8

5 Safety..... 10

5.1 Electrical Safety 10

5.2 Approval Tests 10

6 Reliability..... 10

6.1 General..... 10

1 General

Fan type	Mixed-flow fan	
Rotating direction looking at rotor	Counterclockwise	
Airflow direction	Air outlet over struts	
Bearing system	Ball bearing	
Mounting position - shaft	Any	

2 Mechanics

2.1 General

Width	127,0 mm	
Height	127,0 mm	
Depth	38,0 mm	
Mass	0,485 kg	
Housing material	Mixed	
Impeller material	Plastic	
Max. torque when mounted across both mounting flanges	Wire outlet corner: 100 Ncm Remaining corners: 120 Ncm	
Screw size	ISO 4762 - M4 degreased, without an additional brace and without washer	

2.2 Connections

Electrical connection	Wires	
Lead wire length	L = 310 mm	
Tolerance	+/- 10,0 mm	

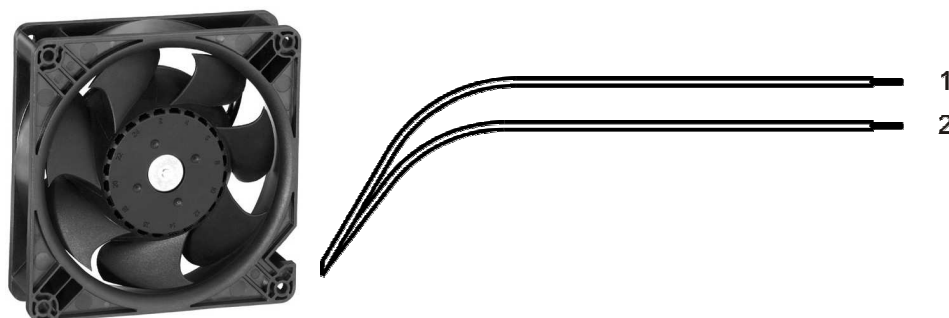

Wire	Color	Operation	Wire size	Insulation diameter
1	red	+ UB	AWG 22	1,70 mm
2	blue	- GND	AWG 22	1,70 mm

The auxiliaries shown on the schematic diagram (which are required for the intended use) are not part of our delivery.

3 Operating Data

3.1 Electrical Operating Data

Measurement conditions: Normal air density = 1,2 kg/m³; Temperature 23°C +/- 3°C; Motor axis horizontal; warm-up time before measuring 5 minutes (unless otherwise specified). In the intake and outlet area should not be any solid obstruction within 0,5 m.

$\Delta p = 0$: corresp. to free air flow (see chapter aerodynamics)
I: corresp. to arithm. mean current value

Features	Condition	Symbol	Values		
Voltage range		U	16,0 V		30,0 V
Nominal voltage		U _N		24,0 V	
Power consumption	$\Delta p = 0$	P	10,2 W	18,5 W	21,3 W
Tolerance	0010		+/- 15 %	+/- 15 %	+/- 15 %
Current consumption	$\Delta p = 0$	I	640 mA	770 mA	710 mA
Tolerance	0010		+/- 15 %	+/- 15 %	+/- 15 %
Speed	$\Delta p = 0$	n	3.900 1/min	5.000 1/min	5.000 1/min
Tolerance	0010		+/- 10 %	+/- 10 %	+/- 10 %

3.2 Electrical Features

Electronic function	Speed-Controlled	
Reversed polarity protection	Rectifying diode	
Max. residual current at U_N	$I_F \leq 10 \text{ mA}$	
Locked rotor protection	Auto restart	
Locked rotor current at U_N	I_{block} approx. 600 mA	
Clock signal at locked rotor	t_3 / t_4 typical: 0,5 s / 5 s	
Internal fuse	Littelfuse NANO2 > Very Fast-Acting > 451/453 Series 3A / 125V (Art.No.: 0451003.MRL)	

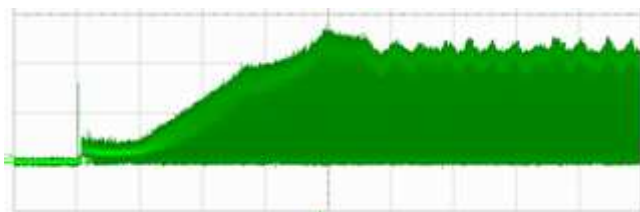
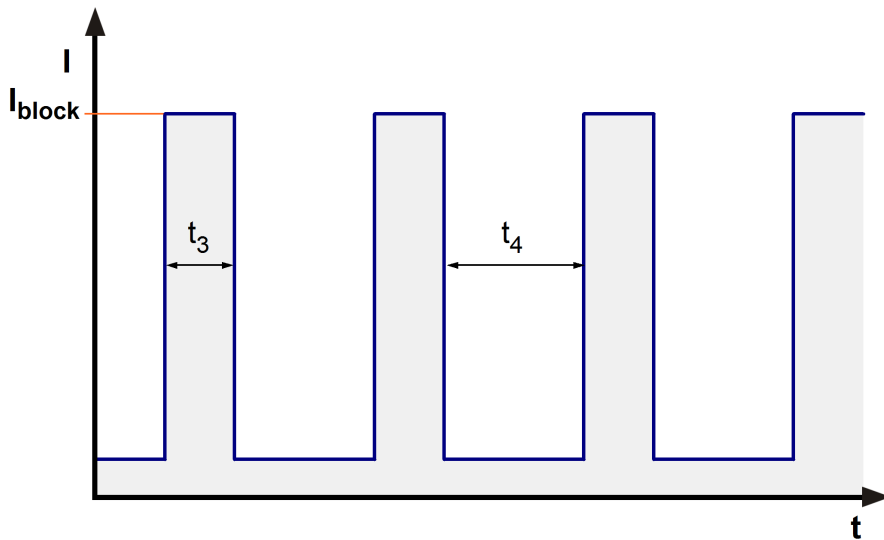

Start-up current @ 24 V ($I = 0,5\text{A/div}$; $t = 2\text{s/div}$)

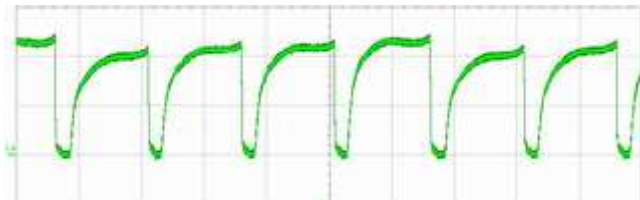

Running current @ 24 V ($I = 0,5\text{A/div}$; $t = 2\text{ms/div}$)



Locked rotor current @ 24 V (I = 0,2A/div ; t = 1s/div)

3.3 Aerodynamics

Measurement conditions: Measured with a double chamber intake rig acc. to DIN EN ISO 5801. Normal air density = 1,2 kg/m³; Temperature 23°C +/- 3°C; In the intake and outlet area should not be any solid obstruction within 0,5 m. Motor shaft horizontal. The information is only valid under the specified test conditions and may be changed by the installation conditions. If there are deviations from the standard test conditions, the characteristic values must be checked under the installed conditions. Power consumption of the fan motor when operating at normal voltage is shown. Depending on the operating conditions of the application, the power input may be higher.

a.) Operation condition:

5.000 1/min at free air flow

Max. free-air flow ($\Delta p = 0 / \dot{V} = \text{max.}$)	270 m ³ /h	
Max. static pressure ($\Delta p = \text{max.} / \dot{V} = 0$)	270 Pa	

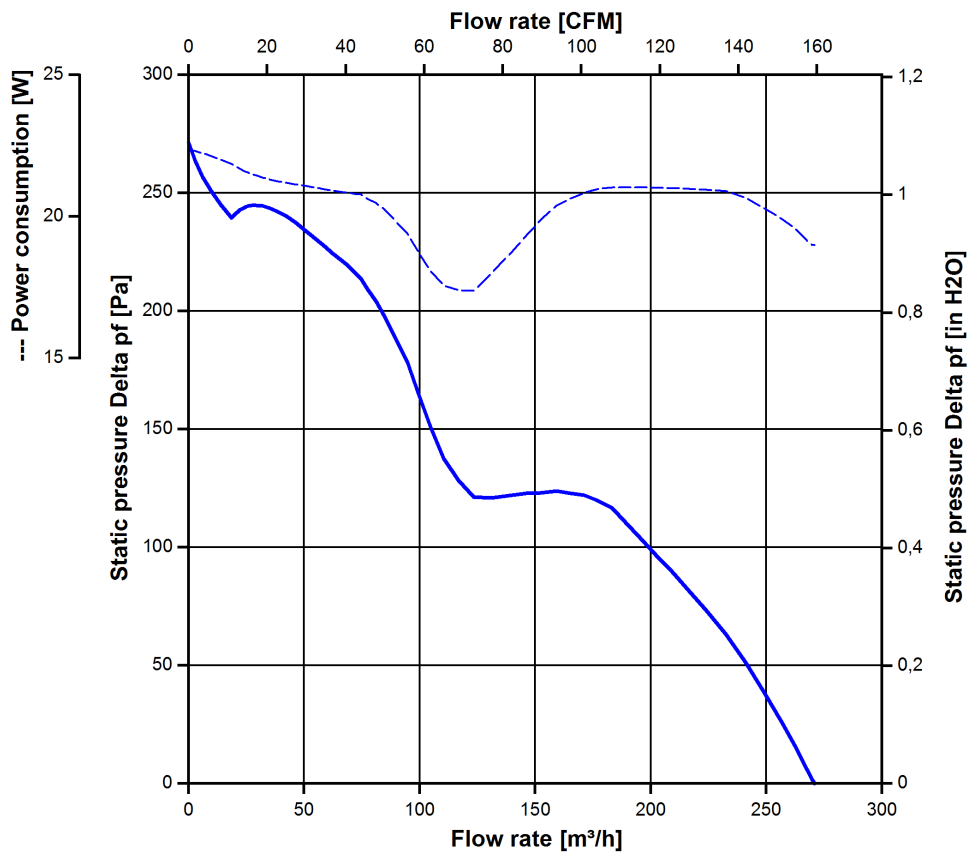

3.4 Sound Data

Measurement conditions: Sound pressure level: 1 meter distance between microphone and the air intake.
Sound power level: Acc. to DIN 45635 part 38 (ISO 10302)
Measured in a semianchoic chamber with a background noise level of $L_p(A) < 5 \text{ dB(A)}$
For further measurement conditions see chapter aerodynamics.

a.) Operation condition:

5.000 1/min at free air flow		
Optimal operating point	190 m ³ /h @ 108 Pa	
Sound power level at the optimal operating point	6,4 bel(A)	
Sound pressure level at free air flow, measured in rubber bands	56,0 dB(A)	

4 Environment

4.1 General

Min. permitted ambient temperature TU min.	-20 °C	
Max. permitted ambient temperature TU max.	65 °C	
Min. permitted storage temperature TL min.	-40 °C	
Max. permitted storage temperature TL max.	80 °C	

4.2 Climatic Requirements

IP-protection type (certified)	IP 68 (for fan only, not for connector if applicable) **)	
Humidity requirements	humid temperature, cyclic; according to DIN EN 60068-2-38, 10 cycle and condensation water check; according to DIN EN ISO 6270-2, 14 days	
Salt fog requirements	None	

Permitted application area:

The product is for the use in partial sheltered rooms or open, roofed areas. Direct exposure to water is allowed provided that this does not prevent the normal operation. Saline ambient conditions must be avoided.

Pollution degree 3 (according DIN EN 60664-1)

It occurs conductive pollution or dry non-conductive pollution which becomes conductive due to condensation.

**) The specification of the IP protection refers to the conditions mentioned in certification of the fan. The above mentioned short description of the protection scope is not final. For detailed information of the respective protection scope and definitions, see certification as well as DIN EN 60529 (protection by housings) and ISO 20653 (for vehicles) with the letter K.

Short description of the IP-protection type:

Solid particle Protection: Dust tight.

Protection against deliberate contact: Protected against contact to hazardous parts with a wire.

Protection against water: The fan test according to IP68 (Based on IEC 60529), is conducted in non-operating mode. The fan is tested by a complete immersion in water for a period of 2h at a water-level of 1,2m. Electrical connections are not immersed since they are customer specific.

Please require severity levels and specification parameters from the responsible development departments.

5 Safety

5.1 Electrical Safety

Dielectric strength DIN EN 60950 (VDE 0805) and DIN EN 60335 (VDE 0700) A.) Type test Measuring conditions: After 48h of storage at 95% R.H. and 25°C. No arcing or breakdown is allowed! All connections together to ground.	500 VAC / 1 Min.	
B.) Routine test Measuring conditions: At indoor climate. No arcing or breakdown is allowed! All connections together to ground.	850 VDC / 1 Sec.	
Isolation resistance Measuring conditions: After 48h of storage at 95% R.H. and 25°C measured with U=500 VDC for 1 min.	RI > 10 MOhm	
Clearance / creepage distance	1,0 mm / 1,2 mm	
Protection class	III	

5.2 Approval Tests

CE	EC Declaration of Conformity	Yes
EAC	Eurasian Conformity	Yes
UL	Underwriters Laboratories	Yes / UL507, Electric Fans E38324
VDE	Association for Electrical, Electronic and Information Technologies	Yes / Approval acc. to EN 60950 (VDE 0805) - Information technology equipment
CSA	Canadian Standards Association	Yes / C22.2 No. 113 Fans and Ventilators
CCC	China Compulsory Certification	Not applicable

6 Reliability

6.1 General

Life expectancy L10 at TU = 40 °C	70.000 h	
Life expectancy L10 at TU max.	40.000 h	
Life expectancy L10 acc. to IPC 9591 at TU = 40 °C	117. 500 h	

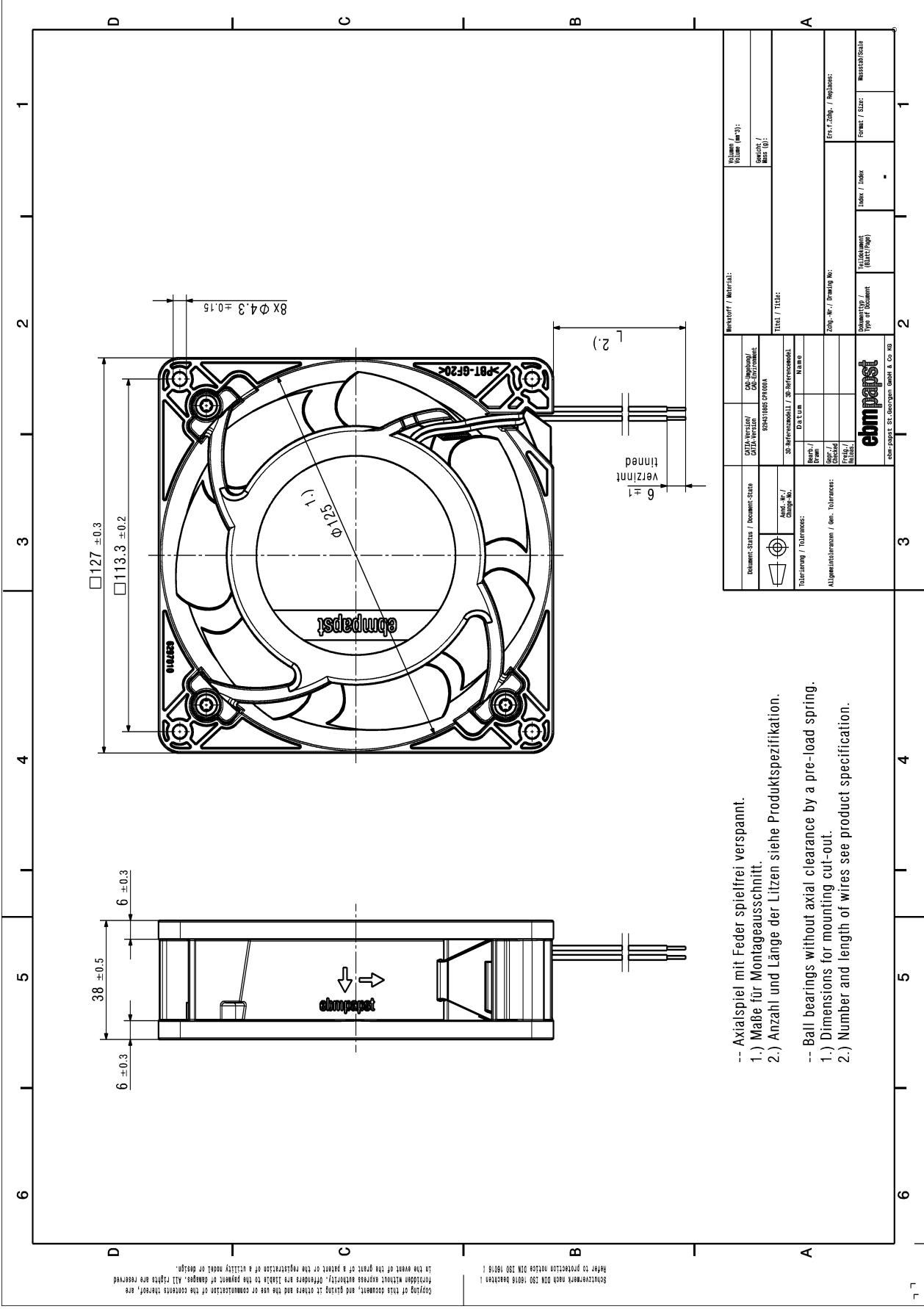

Skizzenwerk nach DIN ISO 15018/1818 beachten!
 Refer to production notes DIN ISO 15018/1818!
 Copying of this document, and giving it others and the use or commission of the contents thereof, are forbidden without express written consent. Offenders are liable to the payment of damages. All rights are reserved in the event of the grant of a patent or the registration of a utility model or design.

- Axialspiel mit Feder spielfrei verspannt.
- 1.) Maße für Montageausschnitt.
- 2.) Anzahl und Länge der Litzen siehe Produktspezifikation.
- Ball bearings without axial clearance by a pre-load spring.
- 1.) Dimensions for mounting cut-out.
- 2.) Number and length of wires see product specification.

Document Status / Document-Status Approved / Genehmigt Change No. / Änderungs-Nr.		CAD-Modell / CAD-Environment 89461986 SP100A		Inventor / Material: Name / Name Date / Datum		Volume / (No. of): Sheets / (No. of): Mass (g) / (Mass (g))	
Tolerierung / Tolerances: Allgemeine Toleranzen / Gen. Tolerances:		3D-Referenzmodell / 3D-Referenzmodell		Title / Titel:		ERS / Zeich. / Revisions:	
Form / Form: Checked / Geprüft: Date / Datum:		6 ± 1 Vertint lined		6 ± 1 Vertint lined		Drawing / (Sheet / Page) Index / Index: Format / Size:	
Drawing No. / Zeichnungs-Nr.: Drawing Title / Zeichnungs-Titel: Drawing Date / Zeichnungs-Datum:		Drawing No. / Zeichnungs-Nr.: Drawing Title / Zeichnungs-Titel: Drawing Date / Zeichnungs-Datum:		Drawing No. / Zeichnungs-Nr.: Drawing Title / Zeichnungs-Titel: Drawing Date / Zeichnungs-Datum:		Drawing No. / Zeichnungs-Nr.: Drawing Title / Zeichnungs-Titel: Drawing Date / Zeichnungs-Datum:	
ebmpapst ebm-papst AG, Georgsmünder Str. 100		ebmpapst ebm-papst AG, Georgsmünder Str. 100		ebmpapst ebm-papst AG, Georgsmünder Str. 100		ebmpapst ebm-papst AG, Georgsmünder Str. 100	