



SPECIFICATION SHEET

SPECIFICATION SHEET NO.	N1004- SOT23SM24CSC24
DATE	Oct. 04, 2021
REVISION	A0
DESCRIPTION	<p>SMD Plastic-Encapsulate ESD Protection Diodes, SOT-23 series, 3 pads SM24C Type, TVS Diodes Array Bi-directional Channels Reverse Working Voltage : 24V, Clamping Voltage 43VC Max.@1.0A</p> <p>Operating Temp. Range -55°C ~+150°C, Package in Tape/Reel, 3000pcs/Reel RoHS/RoHS III compliant</p>
CUSTOMER	
CUSTOMER PART NUMBER	
CROSS REF. PART NUMBER	
ORIGINAL PART NUMBER	MDD SM24C
PART CODE	SOT23SM24CSC24

VENDOR APPROVE			
Issued/Checked/Approved			
DATE: Oct. 04, 2021			

CUSTOMER APPROVE	
DATE:	

SMD ESD PROTECTION DIODES SOT-23 SERIES

MAIN FEATURE

- Peak power dissipation 350W (8/20µs)
- IEC61000-4-2 (ESD) ±15kV (air), ±8kV (contact)
- IEC61000-4-4 (EFT) 40A (5/50ns)
- Protects Two Bi-directional Line
- Low clamping voltage
- Low leakage current
- Working Voltage 3V/5V/8V/12V/15V/18V/20V/24V/36V
- Meet MSL 1 requirement



APPLICATION

- Cell phone handsets and accessories
- Notebooks, Desktops, and Servers Cellular
- Microprocessor based equipment
- Networking and Telecom
- Portable Instrumentation
- Personal Digital Assistants (PDA's)
- Serial and Parallel Ports
- Peripherals

RFQ

[Request For Quotation](#)

PART CODE GUIDE

SOT23	SM24C	S	C24
1	2	3	4

- 1) **SOT23**: SMD Plastic-Encapsulate ESD Protection Diodes, SOT-23 series, 3 pads
- 2) **SM24C**: Type code for original part number SM24C
- 3) **S**: Package code, Package in Tape/Reel, 3000pcs/Reel
- 4) **C24**: Marking code for "C24" on the case surface, Different Marking for different specification.

SMD ESD PROTECTION DIODES SOT-23 SERIES

DIMENSION (Unit: Inch/mm)

Image for reference

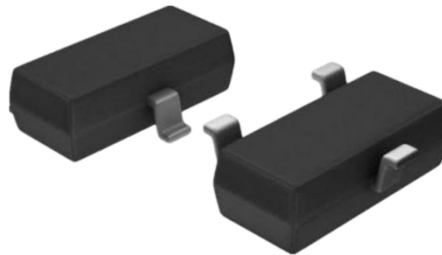

Marking: C24

SOT-23

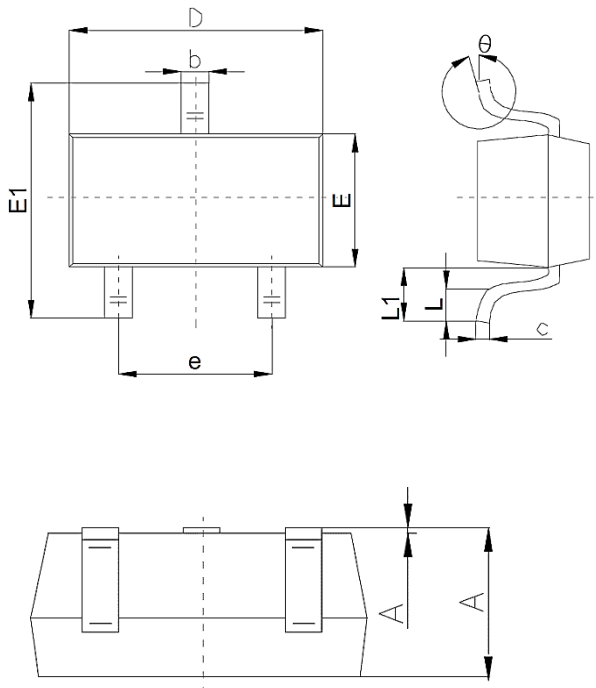

Symbol	Value (mm)		
	Min.	Typ.	Max.
A	0.89	1.00	1.4
A1	0.01	0.06	0.10
b	0.37	0.44	0.50
c	0.09	0.13	0.20
D	2.80	2.90	3.10
E	1.20	1.30	1.60
E1	2.10	2.40	2.80
e	1.78	1.9	2.04
L	0.10		0.30
L1	0.35	0.54	0.69
θ	0°		10°

Recommend Pad Layout

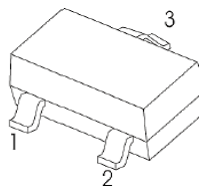
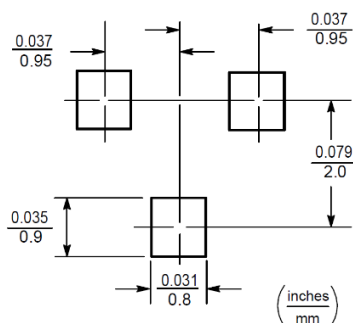

Circuit Diagram

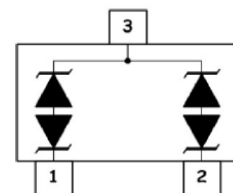

SMD ESD PROTECTION DIODES SOT-23 SERIES

MECHANICAL DATA

Case	Flammability Rating	Terminals	Mounting Position	Weight per piece
JEDEC SOT-323 molded plastic body	UL 94V-0	Matte tin plated	-	-

ABSOLUTE MAX. RATINGS AT Ta=25 °C (unless otherwise specified)

Parameter	SYMBOLS	VALUE	UNITS
		LIMIT	
ESD per IEC 61000-4-2 (Air)	V _{ESD}	+/-15	KV
ESD per IEC 61000-4-2 (Contact)	V _{ESD}	+/-8	KV
Peak Pulse Power @8/20µs	P _{PP}	350	W
Operating Temperature Range	T _J	-55 ~+ 150	°C
Storage Temperature Range	T _{STG}	-55 ~ +150	°C
Lead Solder Temperature- Max. (10 sec. Duration)	T _L	260 /10s	°C

SMD ESD PROTECTION DIODES SOT-23 SERIES

ELECTRICAL CHARACTERISTICS (Ta=25 °C unless otherwise specified)

Parameter	SYMBOLS	VALUE			UNITS
		Min.	Typical	Max.	
Reverse Working Voltage	V _{RWM}			24	V
Reverse Breakdown Voltage @ I _T = 1.0mA	V _{BR}	26.7			V
Reverse Leakage Current @ V _{RWM} = 24V	I _R			1.0	μA
Clamping Voltage @ I _{PP} = 1.0A, t _p = 8/20μs	V _C			43	V
Clamping Voltage @ I _{PP} = 7A, t _p = 8/20μs	V _C			52.0	V
Junction Capacitance @ V _R = 0V, f = 1MHz	C _T			50	pF

SMD ESD PROTECTION DIODES SOT-23 SERIES
RELIABILITY

Number	Experiment Items	Experiment Method And Conditions	Reference Documents
1	Solder Resistance Test	Test 260°C± 5°C for 10 ± 2 sec. Immerse body into solder 1/16" ± 1/32"	MIL-STD-750D METHOD-2031.2
2	Solderability Test	230°C ±5°C for 5 sec.	MIL-STD-750D METHOD-2026.1 0
3	Pull Test	1 kg in axial lead direction for 10 sec.	MIL-STD-750D METHOD-2036.4
4	Bend Test	0.5Kg Weight Applied To Each Lead, Bending Arcs 90 °C ± 5 °C For 3 Times	MIL-STD-750D METHOD-2036.4
5	High Temperature Reverse Bias Test	TA=100°C for 1000 Hours at VR=80% Rated VR	MIL-STD-750D METHOD-1038.4
6	Forward Operation Life Test	TA=25°C Rated Average Rectified Current	MIL-STD-750D METHOD-1027.3
7	Intermittent Operation Life Test	On state: 5 min with rated IRMS Power Off state: 5 min with Cool Forced Air. On and off for 1000 cycles.	MIL-STD-750D METHOD-1036.3
8	Pressure Cooker Test	15 PSIG, TA=121°C, 4 hours	MIL-S-19500 APPENOIXC
9	Temperature Cycling Test	-55°C~+125°C; 30 Minutes For Dwelled Time 5 minutes for transferred time. Total: 10 cycles.	MIL-STD-750D METHOD-1051.7
10	Thermal Shock Test	0°C for 5 minutes., 100°C for 5minutes, Total: 10 cycles	MIL-STD-750D METHOD-1056.7
11	Forward Surge Test	8.3ms Single Sale Sine-wave One Surge.	MIL-STD-750D METHOD-4066.4
12	Humidity Test	TA=65°C, RH=98% for 1000 hours.	MIL-STD-750D METHOD-1021.3
13	High Temperature Storage life Test	150°C for 1000 Hours	MIL-STD-750D METHOD-1031.5

SMD ESD PROTECTION DIODES SOT-23 SERIES

SUGGESTED REFLOW PROFILE (For Reference Only)

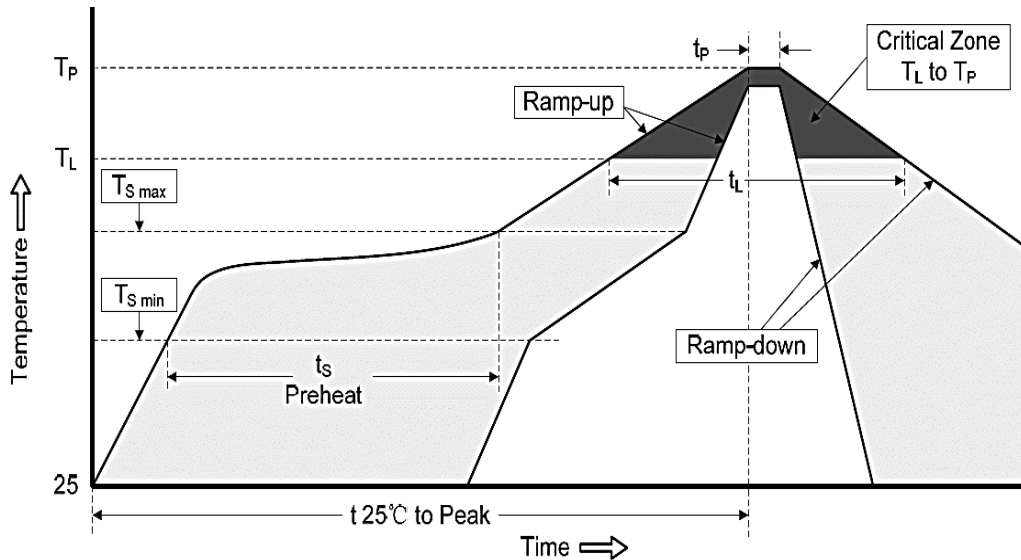

Profile Feature		Pb-Free Assembly
Average Ramp-up Rate (Ts Max to Tp)		3°C/second Max
Preheat	Temperature Min (Ts Min.)	150°C
	Temperature Max (Ts Max.)	200°C
	Time (ts Min. to ts Max.)	60 ~ 180 seconds
Time maintained above	Temperature (Tl)	217°C
	Time (tl)	60 ~ 150 seconds
Peak/Classification Temperature (Tp)		260 °C
Time within 5°C of actual Peak Temperature (tp)		20 ~ 40 seconds
Ramp-down rate		6 °C /Second Max.
Time 25 °C to Peak Temperature		8 minutes Max.
Suggest reflow times		3 Times Max.

SMD ESD PROTECTION DIODES SOT-23 SERIES

RATINGS AND CHARACTERISTIC CURVES (For Reference Only)

Fig 1 8/20µs Waveform per IEC61000-4-5

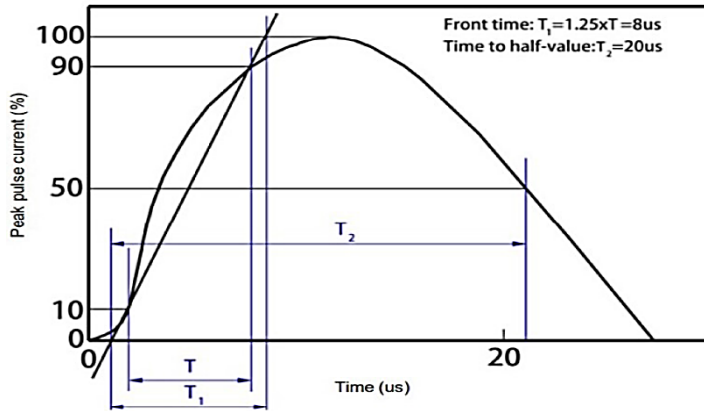

Fig 2 Contact Discharge Current Waveform per IEC 61000-4-2)

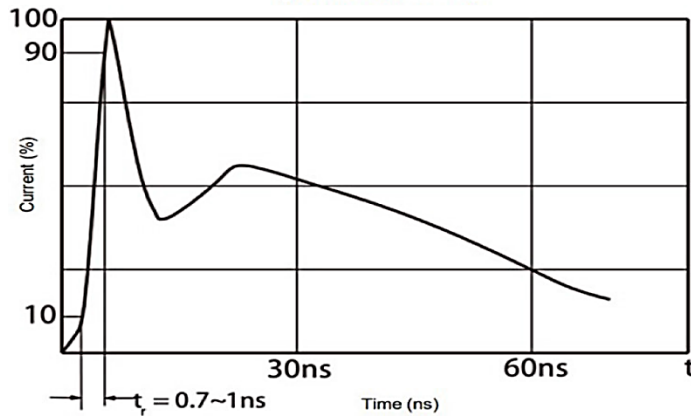
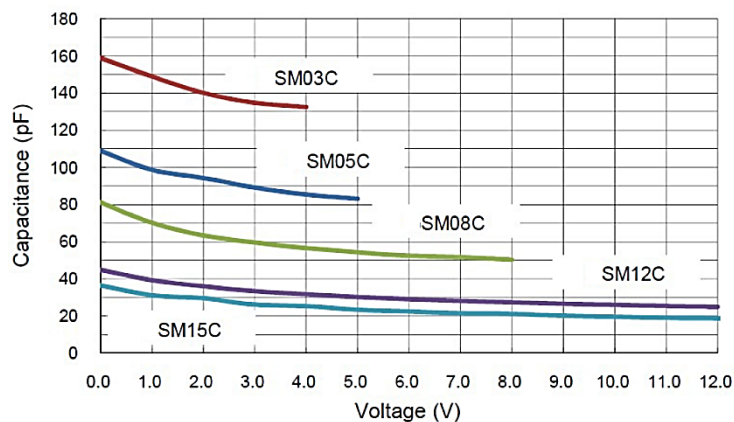

Fig 3 Voltage vs Capacitance



SMD ESD PROTECTION DIODES SOT-23 SERIES

RATINGS AND CHARACTERISTIC CURVES (For Reference Only)

Fig 4 Voltage vs Capacitance

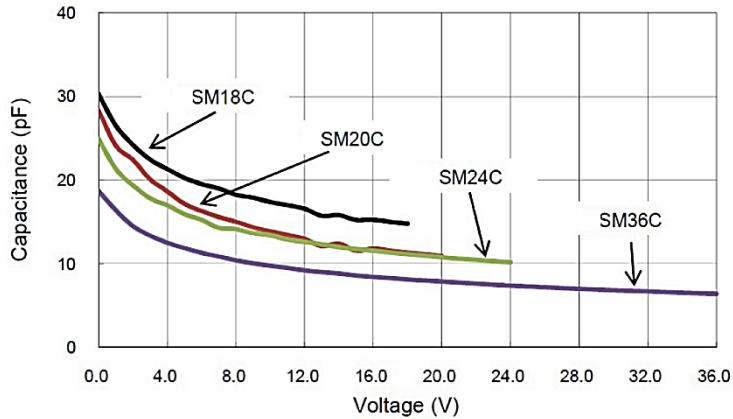

Fig 5 Clamping Voltage vs Peak Pulse Current

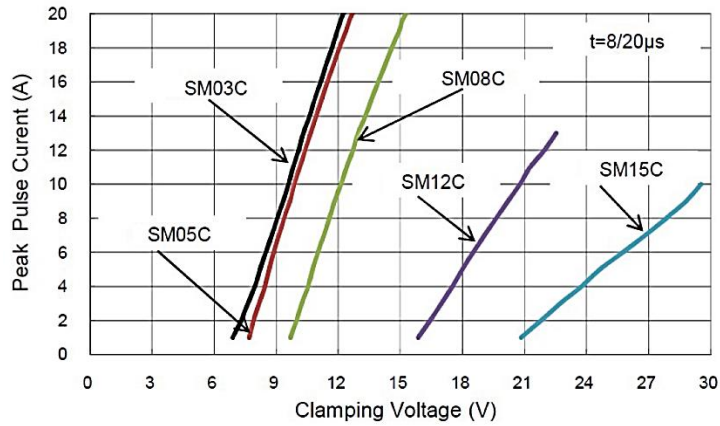
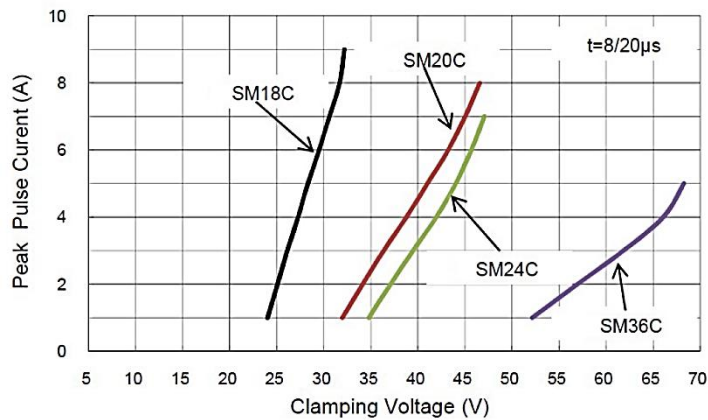

Fig 6 Clamping Voltage vs Peak Pulse Current



SMD ESD PROTECTION DIODES SOT-23 SERIES

TAPE/REEL (Unit: mm)

All Devices are packed in accordance with EIA standard RS-481-A and specifications.

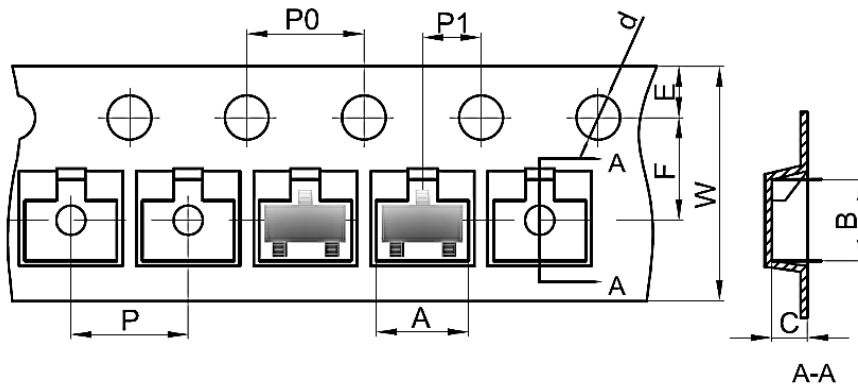

Case	A	B	C	d	E	F	P0	P	P1	W
SOT-23	3.15	2.77	1.22	∅1.5	1.75	3.5	4.0	4.0	2.0	8.0

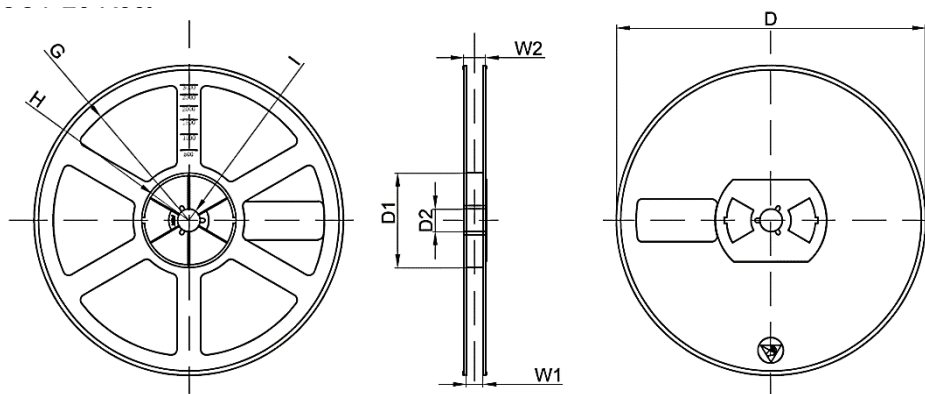
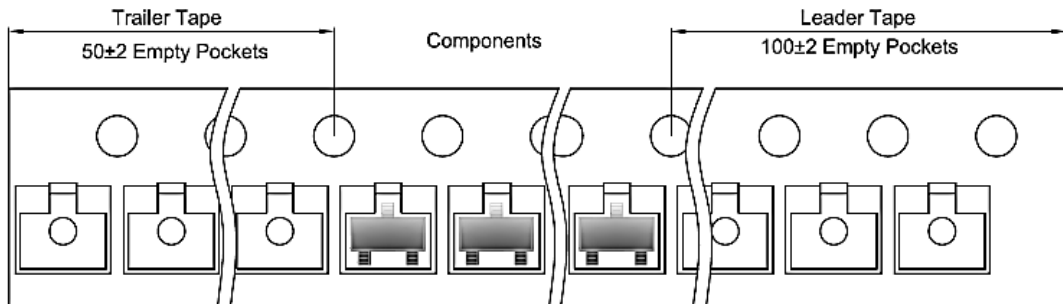

Reel Size	D	D1	D2	G	H	I	W1	W2
7"	∅178	54.4	13.0	R78.0	R25.6	R6.5	9.5	12.3

SMD ESD PROTECTION DIODES SOT-23 SERIES

SPQ PACKAGE for Reference

Item	Unit	Value
Case Code		SOT-23
Reel Size	Inch	7
Reel Size	mm	178
Tape Space	mm	/
SPQ /Reel	pcs	3000
Weigh /SPQ	LBS	-
Weigh /SPQ	KGs	-
Qty. Per Box	pcs	6000
Inner Box	Inch	L8.0*W8.0*H1.5

DISCLAIMER

NextGen Component, Inc. reserves the right to make changes to the product(s) and or information contained herein without notice. No liability is assumed as a result of their use or application. No rights under any patent accompany the sale of any such product(s) or information