

LT P4SG

PointLED®

With a diameter of just 2 mm, the PointLED is one of the smallest packages in its class and achieves high luminous efficacies.

Due to its round and flat package, measuring only 0.775 mm high, it is ideal for application where space is a sensitive issue.



Applications

- Cluster, Button Backlighting
- Electronic Equipment
- Gaming, Amusement, Gambling
- Health Monitoring (Heart Rate Monitoring, Pulse Oximetry)
- Interior Illumination (e.g. Ambient Map)
- Transportation, Plane, Ship
- White Goods

Features:

- Package: white SMT package, colorless clear silicone resin
- Chip technology: ThinGaN
- Typ. Radiation: 120° (Lambertian emitter)
- Color: $\lambda_{\text{dom}} = 528 \text{ nm}$ (● true green)
- Corrosion Robustness Class: 1B
- ESD: 2 kV acc. to ANSI/ESDA/JEDEC JS-001 (HBM, Class 2)

Ordering Information

| Type | Luminous Intensity ¹⁾ $I_F = 20 \text{ mA}$ I_v | Mounting methode | Ordering Code |
|-------------------|--|------------------|---------------|
| LT P4SG-V1AB-36-1 | 710 ... 1800 mcd | Reverse | Q65110A7127 |
| LT P4SG-V1AB-36-F | 710 ... 1800 mcd | Top | Q65110A6029 |

Maximum Ratings

| Parameter | Symbol | | Values |
|--|-----------|------|--------|
| Operating Temperature | T_{op} | min. | -40 °C |
| | | max. | 100 °C |
| Storage Temperature | T_{stg} | min. | -40 °C |
| | | max. | 100 °C |
| Junction Temperature | T_j | max. | 125 °C |
| Forward current $T_s = 25\text{ °C}$ | I_F | min. | 3 mA |
| | | max. | 20 mA |
| Surge Current $t \leq 10\ \mu\text{s}$; $D = 0.005$; $T_s = 25\text{ °C}$ | I_{FS} | max. | 200 mA |
| Reverse voltage ²⁾ $T_s = 25\text{ °C}$ | V_R | max. | 12 V |
| ESD withstand voltage acc. to ANSI/ESDA/JEDEC JS-001 (HBM, Class 2) | V_{ESD} | | 2 kV |

Characteristics

$I_F = 20 \text{ mA}$; $T_S = 25 \text{ °C}$

| Parameter | Symbol | | Values |
|---|-------------------------------------|------|--------------------|
| Peak Wavelength | λ_{peak} | typ. | 523 nm |
| Dominant Wavelength ³⁾ $I_F = 20 \text{ mA}$ | λ_{dom} | min. | 519 nm |
| | | typ. | 528 nm |
| | | max. | 543 nm |
| Spectral Bandwidth at 50% $I_{\text{rel,max}}$ | $\Delta\lambda$ | typ. | 33 nm |
| Viewing angle at 50% I_V | 2ϕ | typ. | 120 ° |
| Forward Voltage ⁴⁾ $I_F = 20 \text{ mA}$ | V_F | min. | 2.90 V |
| | | typ. | 3.20 V |
| | | max. | 3.70 V |
| Reverse current ²⁾ $V_R = 12 \text{ V}$ | I_R | typ. | 0.01 μA |
| | | max. | 10 μA |
| Temperature Coefficient of Peak Wavelength $-10\text{°C} \leq T \leq 100\text{°C}$ | $\text{TC}_{\lambda_{\text{peak}}}$ | typ. | 0.04 nm / K |
| Real thermal resistance junction/solderpoint ⁵⁾ | $R_{\text{thJS real}}$ | max. | 240 K / W |

Brightness Groups

| Group | Luminous Intensity ¹⁾ $I_F = 20 \text{ mA}$ min. I_v | Luminous Intensity ¹⁾ $I_F = 20 \text{ mA}$ max. I_v | Luminous Flux ⁶⁾ $I_F = 20 \text{ mA}$ typ. Φ_v |
|-------|--|--|--|
| V1 | 710 mcd | 900 mcd | 2420 mlm |
| V2 | 900 mcd | 1120 mcd | 3030 mlm |
| AA | 1120 mcd | 1400 mcd | 3780 mlm |
| AB | 1400 mcd | 1800 mcd | 4800 mlm |

Forward Voltage Groups

| Group | Forward Voltage ⁴⁾ $I_F = 20 \text{ mA}$ min. V_F | Forward Voltage ⁴⁾ $I_F = 20 \text{ mA}$ max. V_F |
|-------|---|---|
| 4 | 2.90 V | 3.20 V |
| 5 | 3.20 V | 3.50 V |
| 6 | 3.50 V | 3.70 V |

Wavelength Groups

| Group | Dominant Wavelength ³⁾ $I_F = 20 \text{ mA}$ min. λ_{dom} | Dominant Wavelength ³⁾ $I_F = 20 \text{ mA}$ max. λ_{dom} |
|-------|--|--|
| 3 | 519 nm | 525 nm |
| 4 | 525 nm | 531 nm |
| 5 | 531 nm | 537 nm |
| 6 | 537 nm | 543 nm |

Group Name on Label

Example: AA-3-4

Brightness

Wavelength

Forward Voltage

AA

3

4

Relative Spectral Emission ⁶⁾

$I_{rel} = f(\lambda); I_F = 20 \text{ mA}; T_S = 25 \text{ }^\circ\text{C}$

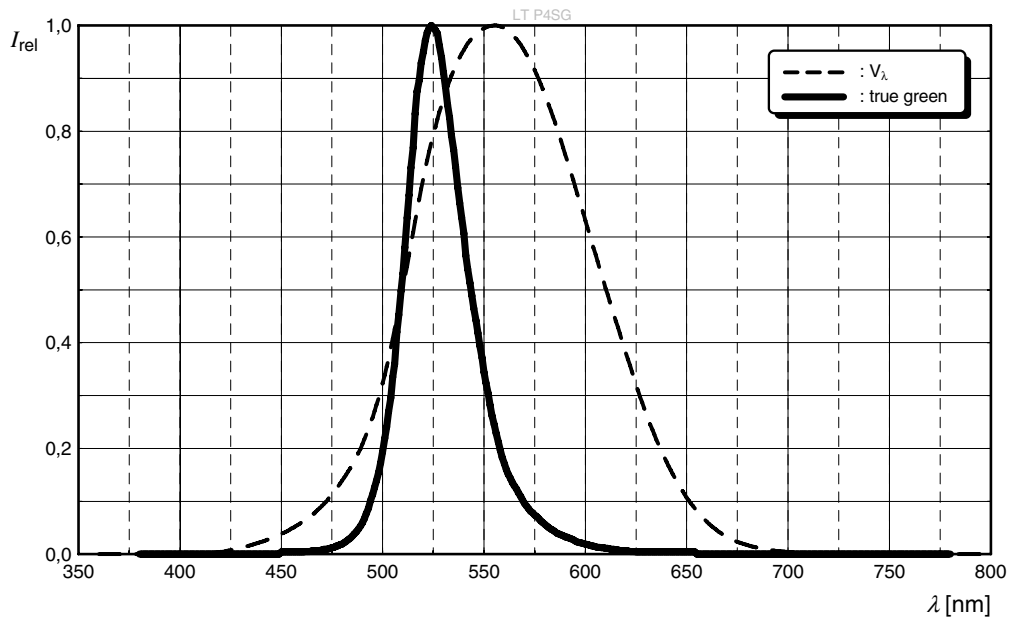

Radiation Characteristics ⁶⁾

$I_{rel} = f(\phi); T_S = 25 \text{ }^\circ\text{C}$

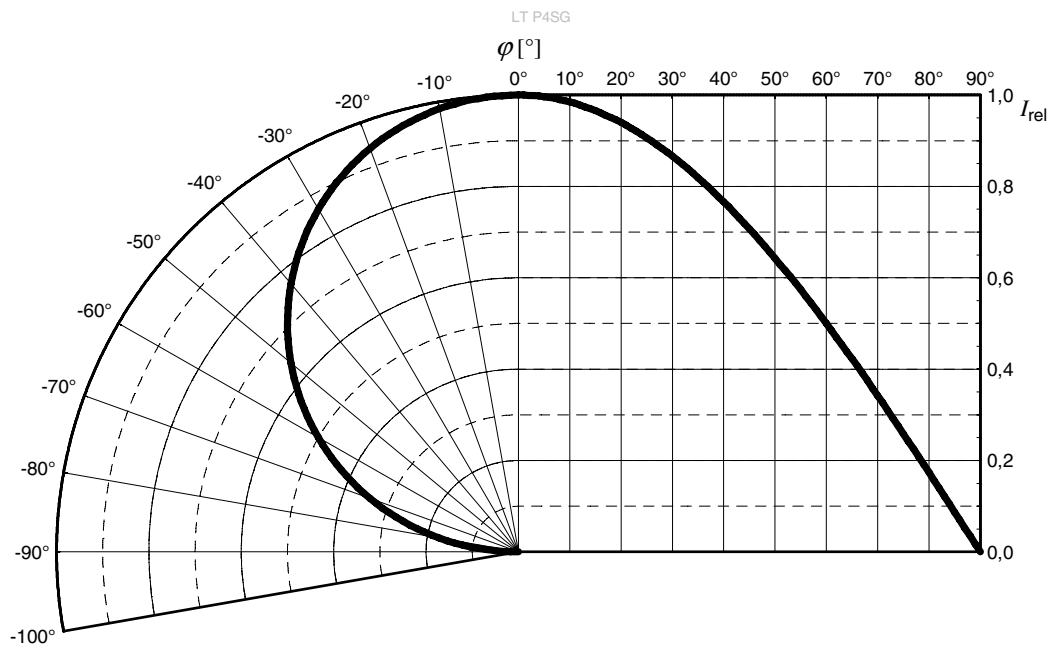

Discontinued

Forward current ^{6), 7)}

$I_F = f(V_F); T_S = 25\text{ °C}$

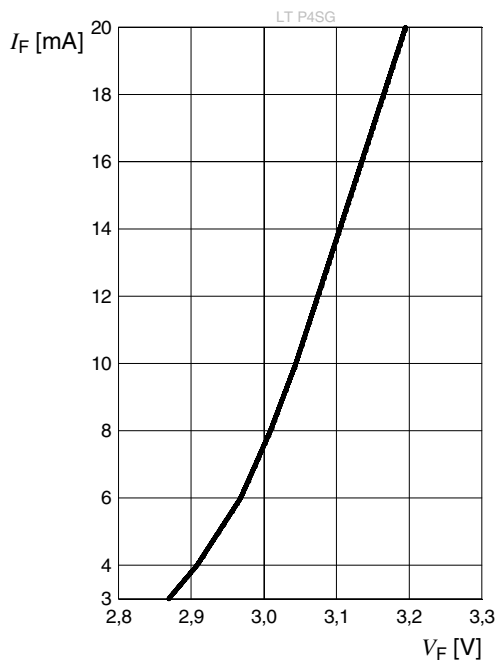

Relative Luminous Intensity ^{6), 7)}

$I_V/I_V(20\text{ mA}) = f(I_F); T_S = 25\text{ °C}$

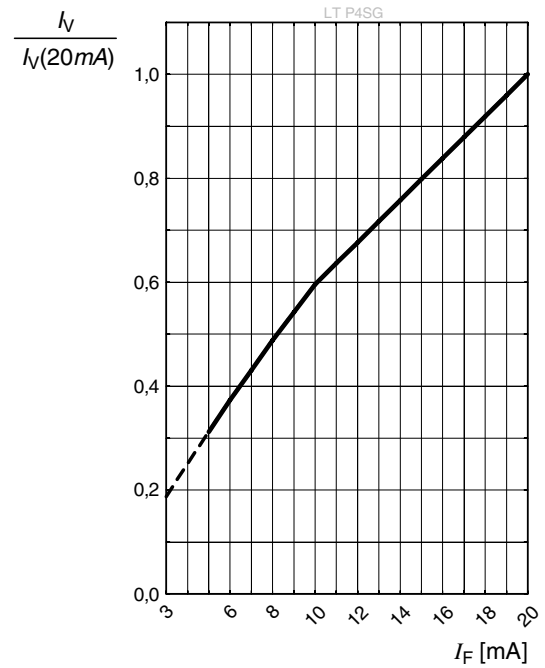

Dominant Wavelength ⁶⁾

$\lambda_{\text{dom}} = f(I_F); T_S = 25\text{ °C}$

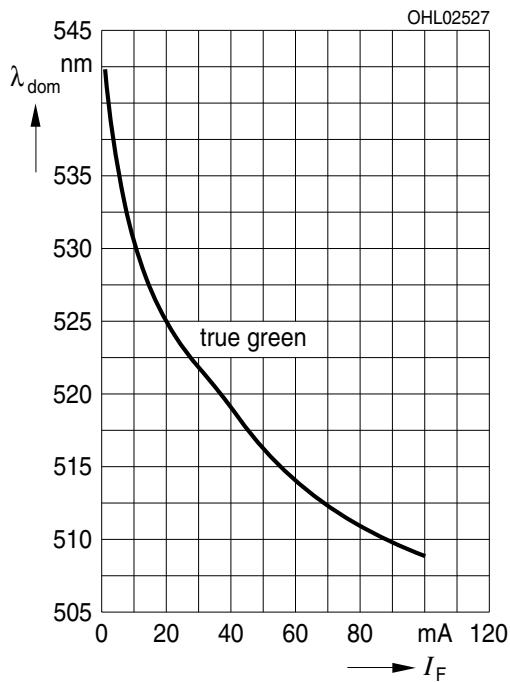

Discontinued

Forward Voltage ⁶⁾

$$\Delta V_F = V_F - V_F(25\text{ °C}) = f(T_j); I_F = 20\text{ mA}$$

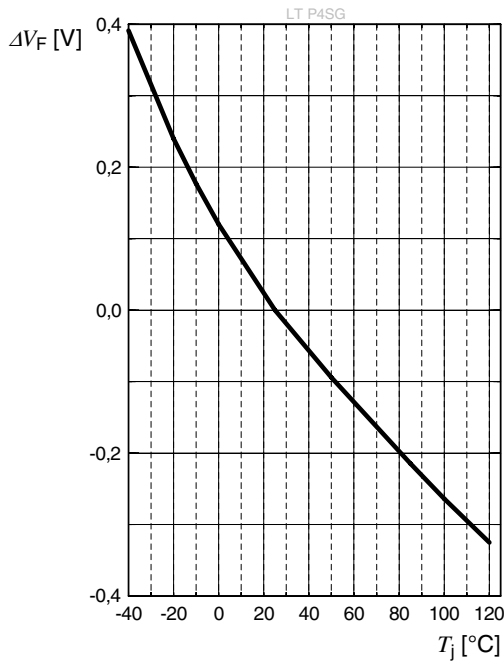

Relative Luminous Intensity ⁶⁾

$$I_V/I_V(25\text{ °C}) = f(T_j); I_F = 20\text{ mA}$$

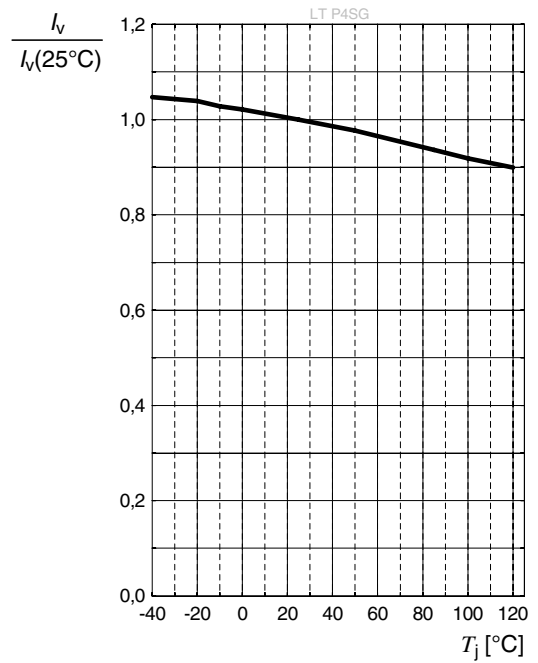

Dominant Wavelength ⁶⁾

$$\lambda_{\text{dom}} = f(T_j); I_F = 20\text{ mA}$$

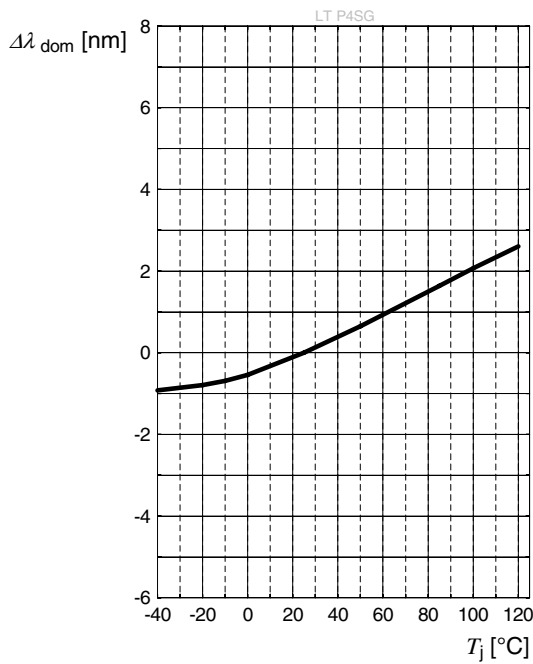

Discontinued

Max. Permissible Forward Current

$I_F = f(T)$

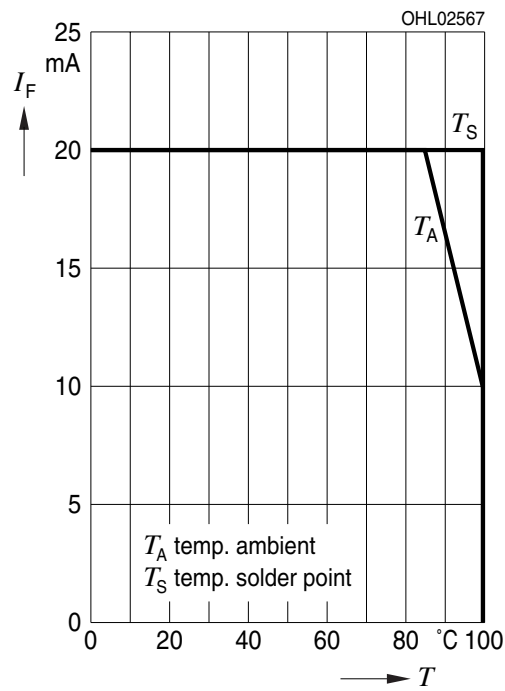

Permissible Pulse Handling Capability

$I_F = f(t_p)$; D: Duty cycle; $T_s = 25\text{ °C}$

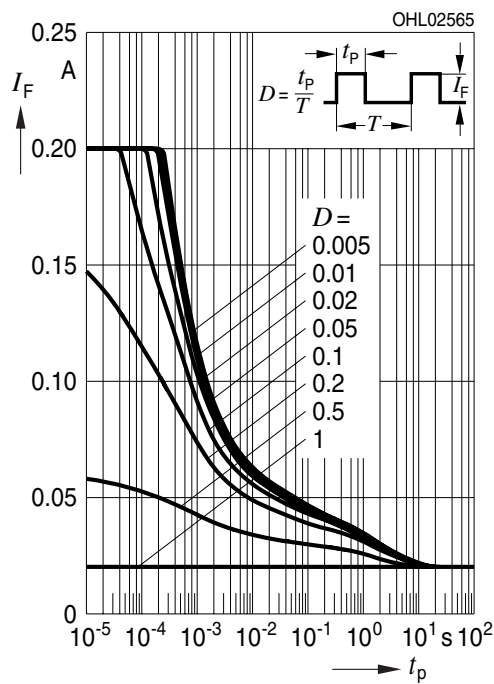

Permissible Pulse Handling Capability

$I_F = f(t_p)$; D: Duty cycle; $T_s = 85\text{ °C}$

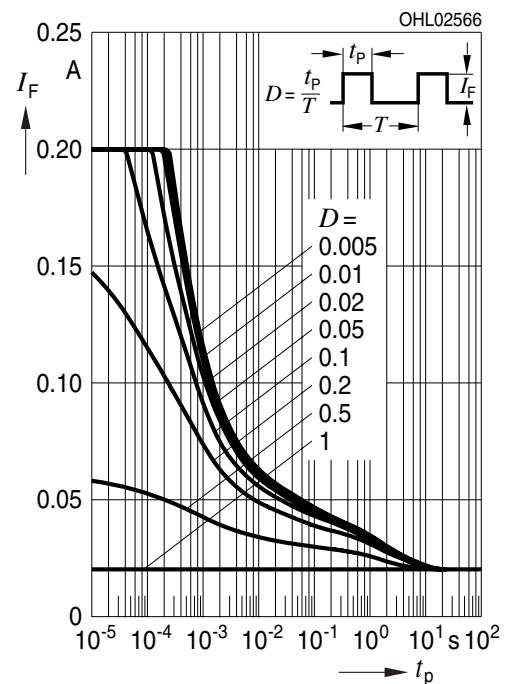

Discontinued

Dimensional Drawing ⁸⁾

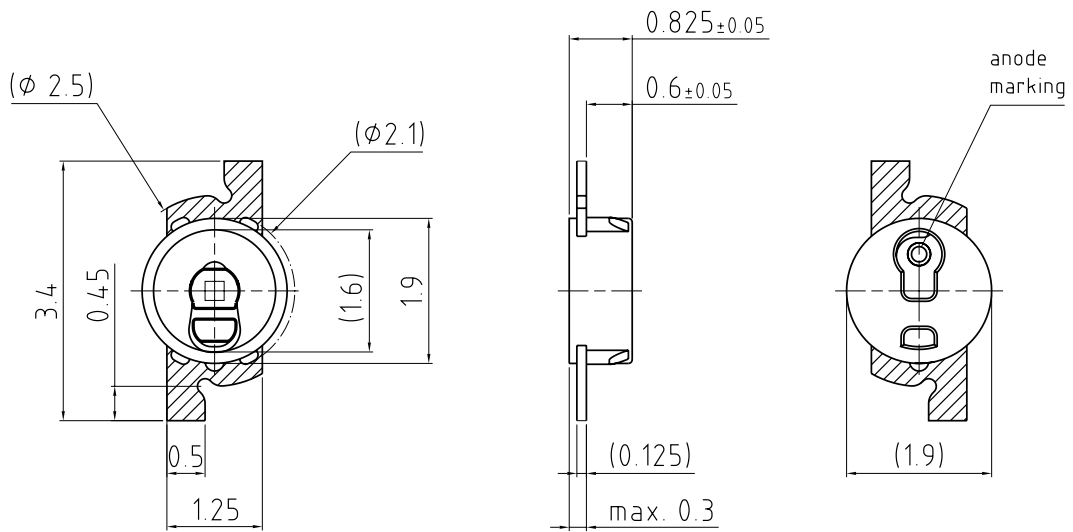

general tolerance ± 0.1
 lead finish Sn 

C63062-A3773-A40..-06

Further Information

Approximate Weight: 6.0 mg

Corrosion test: Class: 1B
 Test condition: 25°C / 75 % RH / 200ppb SO₂, 200ppb NO₂, 10ppb H₂S,
 10ppb Cl₂ / 21 days (EN 60068-2-60 (Method 4))

Recommended Solder Pad ⁸⁾

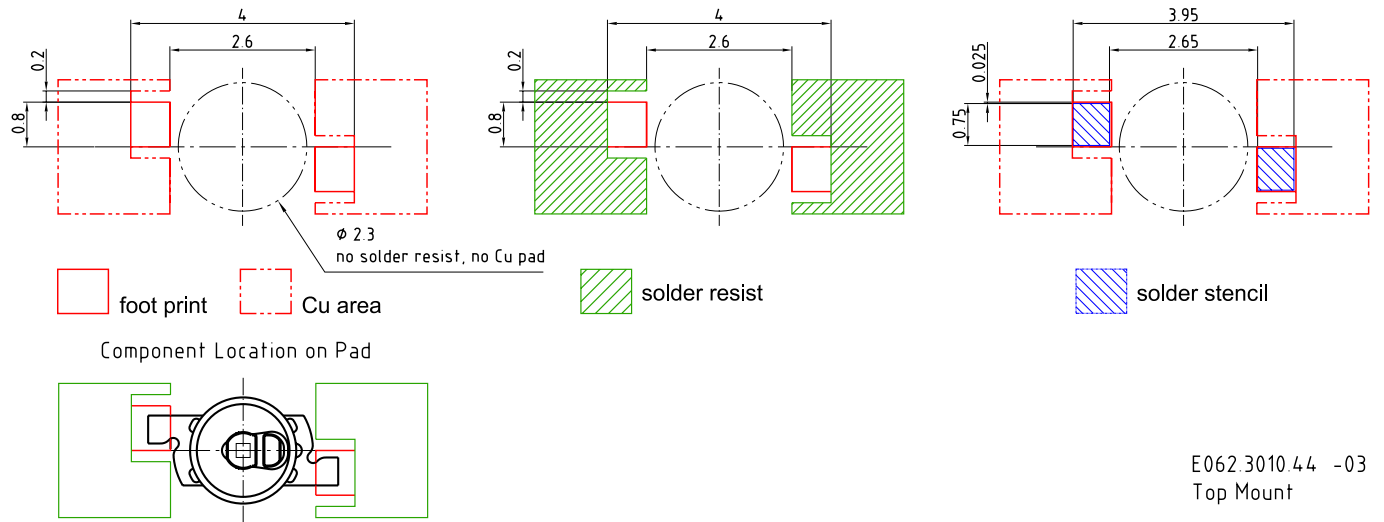

Recommended Solder Pad ⁸⁾

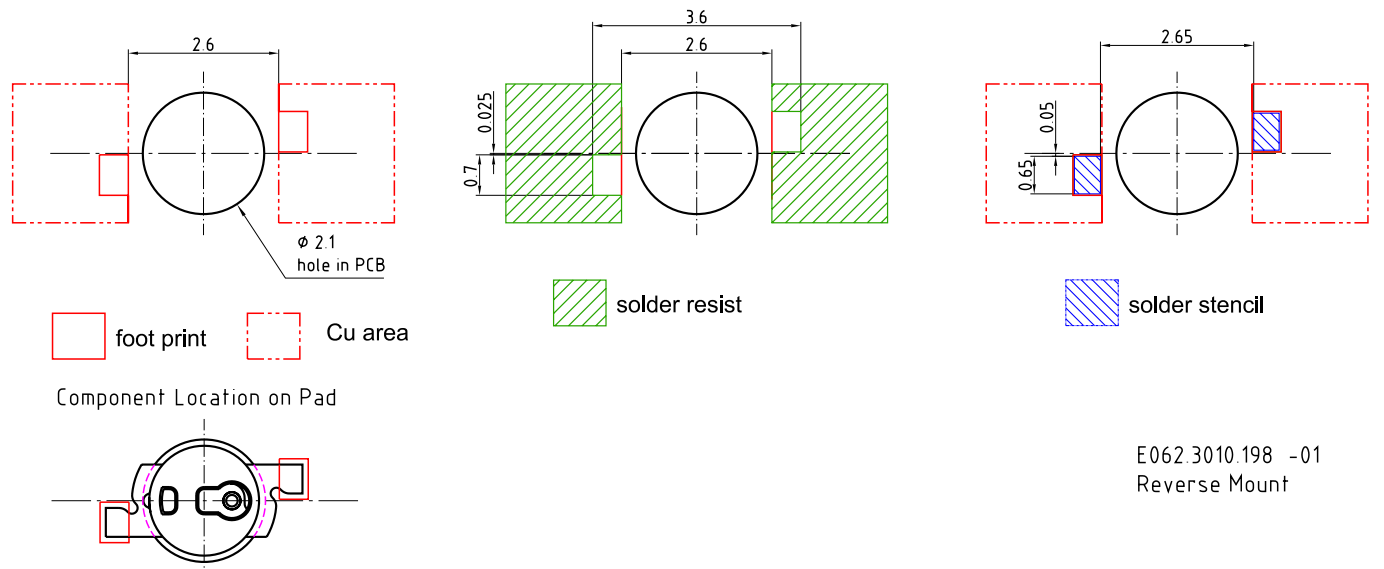

Discontinued

For superior solder joint connectivity results we recommend soldering under standard nitrogen atmosphere. Package not suitable for ultra sonic cleaning.

Reflow Soldering Profile

Product complies to MSL Level 2 acc. to JEDEC J-STD-020E

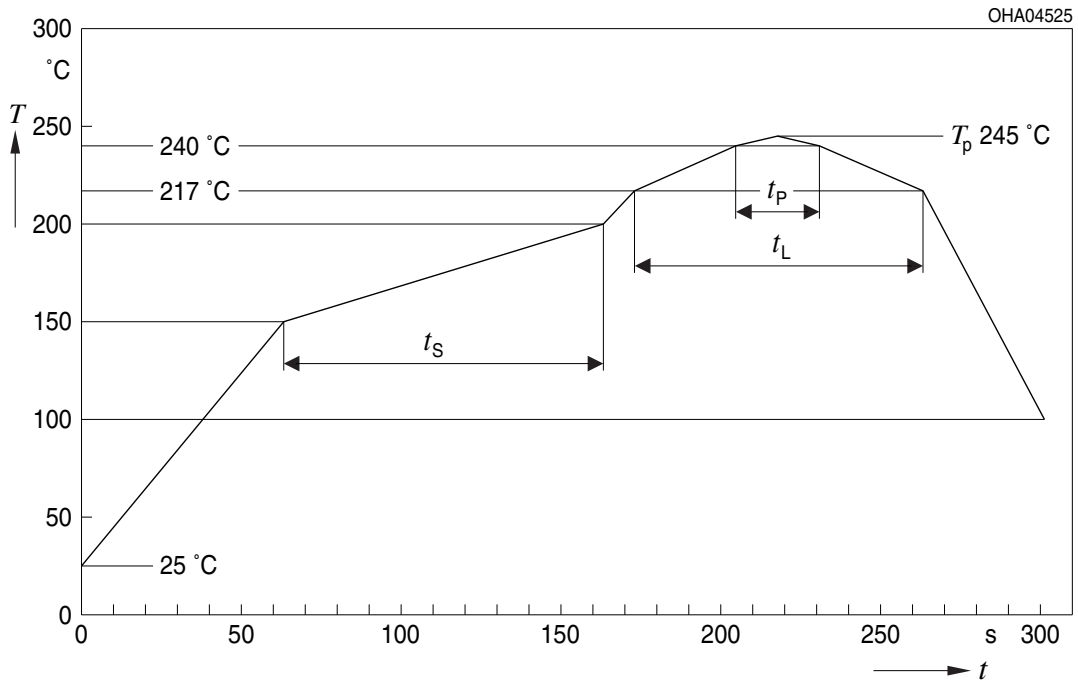

| Profile Feature | Symbol | Pb-Free (SnAgCu) Assembly | | | Unit |
|--|--------|---------------------------|----------------|---------|------|
| | | Minimum | Recommendation | Maximum | |
| Ramp-up rate to preheat ^{*)} 25 °C to 150 °C | | | 2 | 3 | K/s |
| Time t_s T_{Smin} to T_{Smax} | t_s | 60 | 100 | 120 | s |
| Ramp-up rate to peak ^{*)} T_{Smax} to T_p | | | 2 | 3 | K/s |
| Liquidus temperature | T_L | | 217 | | °C |
| Time above liquidus temperature | t_L | | 80 | 100 | s |
| Peak temperature | T_p | | 245 | 260 | °C |
| Time within 5 °C of the specified peak temperature $T_p - 5$ K | t_p | 10 | 20 | 30 | s |
| Ramp-down rate* T_p to 100 °C | | | 3 | 6 | K/s |
| Time 25 °C to T_p | | | | 480 | s |

All temperatures refer to the center of the package, measured on the top of the component
 *) slope calculation DT/Dt : Dt max. 5 s; fulfillment for the whole T-range

Discontinued

Taping ⁸⁾

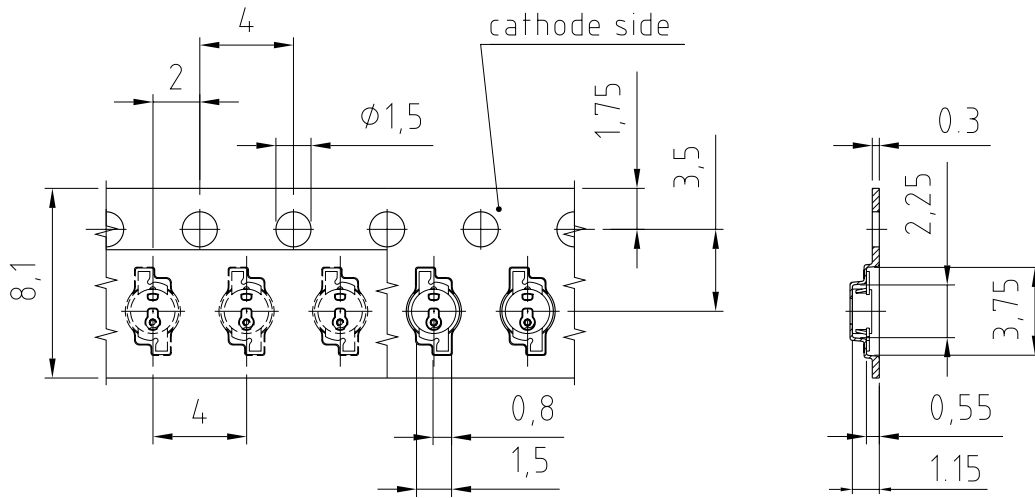

C63062-A3773-B14 -04
Reverse Mount

Taping ⁸⁾

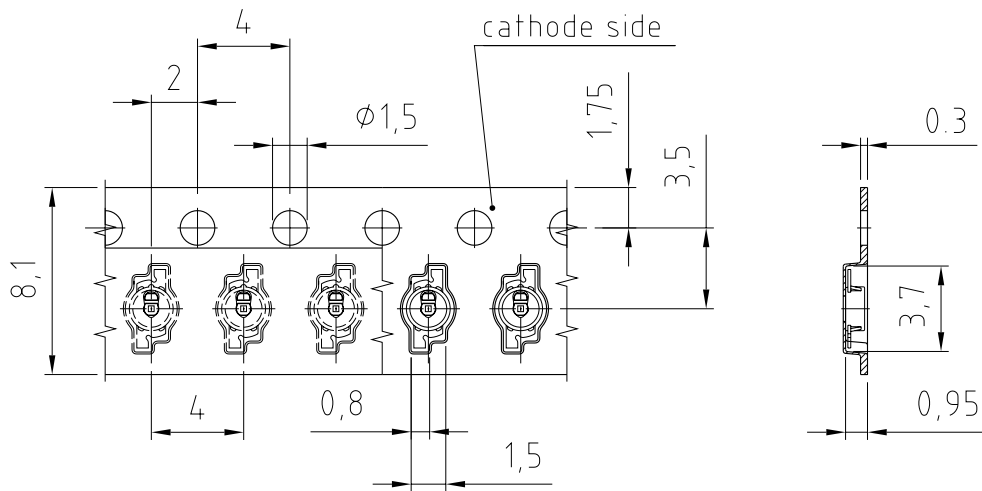

C63062-A3773-B16 -04
Top Mount

Discontinued

Tape and Reel ⁹⁾



Reel Dimensions

| A | W | N_{min} | W_1 | W_{2max} | Pieces per PU |
|--------|--------------------|-----------|------------|------------|---------------|
| 180 mm | 8 + 0.3 / - 0.1 mm | 60 mm | 8.4 + 2 mm | 14.4 mm | 3000 |
| 330 mm | 8 + 0.3 / - 0.1 mm | 60 mm | 8.4 + 2 mm | 14.4 mm | 12000 |

Barcode-Product-Label (BPL)

OSRAM Opto Semiconductors LX XXXX BIN1: XX-XX-X-XXX-X

RoHS Compliant

(6P) BATCH NO: 1234567890 ML Temp ST
X XXX °C X

(1T) LOT NO: 1234567890 (9D) D/C: 1234



Pack: RXX
DEMY XXX
X_X123_1234.1234 X



(X) PROD NO: 123456789(Q)QTY: 9999 (G) GROUP: XX-XX-X-X



OHA04563

Dry Packing Process and Materials ⁸⁾



OHA00539

Moisture-sensitive product is packed in a dry bag containing desiccant and a humidity card according JEDEC-STD-033.

Discontinued

Schematic Transportation Box ⁸⁾

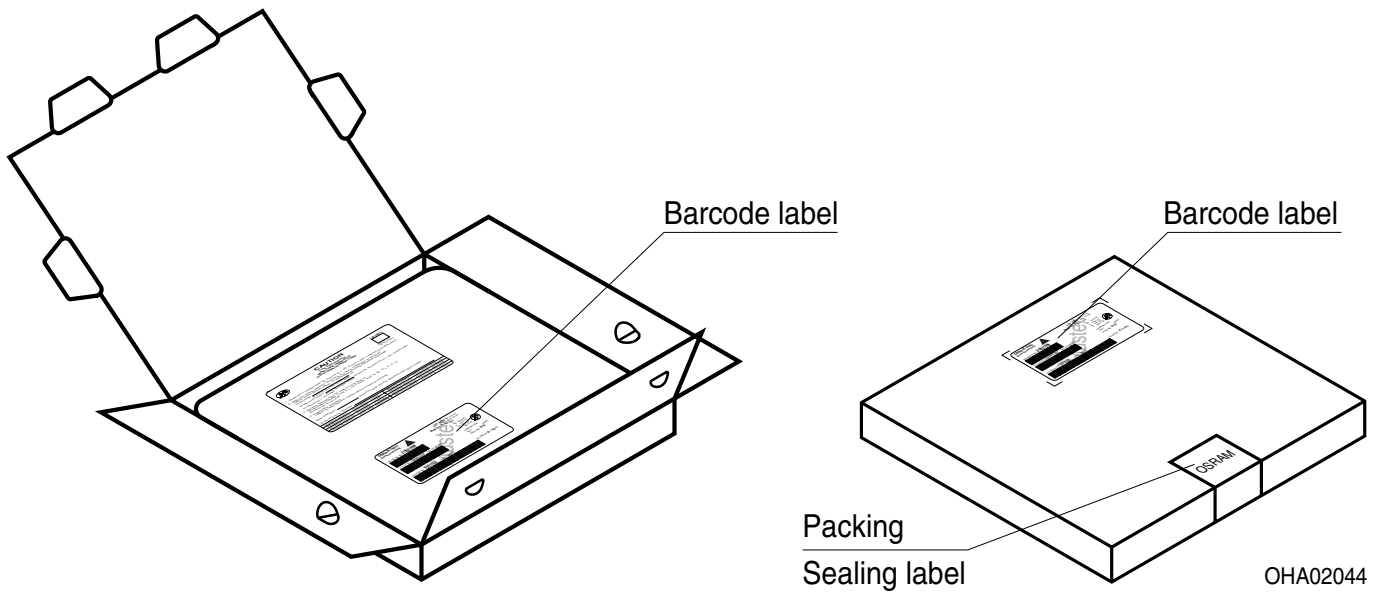

Dimensions of Transportation Box

| Width | Length | Height |
|------------|------------|-----------|
| 200 ± 5 mm | 195 ± 5 mm | 30 ± 5 mm |
| 352 ± 5 mm | 352 ± 5 mm | 33 ± 5 mm |

Type Designation System

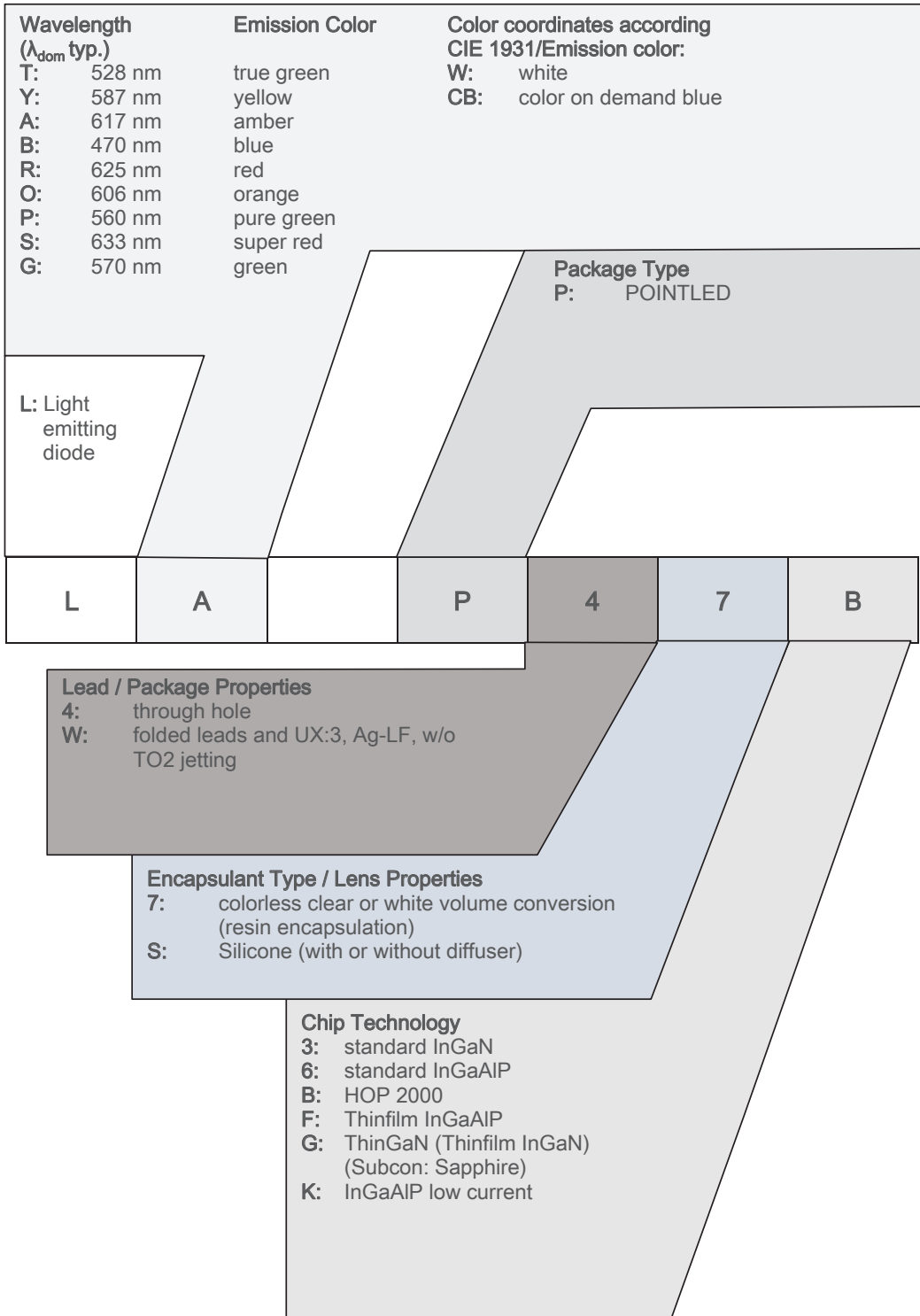

Discontinued

Notes

The evaluation of eye safety occurs according to the standard IEC 62471:2006 (photo biological safety of lamps and lamp systems). Within the risk grouping system of this IEC standard, the device specified in this data sheet falls into the class **exempt group (exposure time 10000 s)**. Under real circumstances (for exposure time, conditions of the eye pupils, observation distance), it is assumed that no endangerment to the eye exists from these devices. As a matter of principle, however, it should be mentioned that intense light sources have a high secondary exposure potential due to their blinding effect. When looking at bright light sources (e.g. headlights), temporary reduction in visual acuity and afterimages can occur, leading to irritation, annoyance, visual impairment, and even accidents, depending on the situation.

Subcomponents of this device contain, in addition to other substances, metal filled materials including silver. Metal filled materials can be affected by environments that contain traces of aggressive substances. Therefore, we recommend that customers minimize device exposure to aggressive substances during storage, production, and use. Devices that showed visible discoloration when tested using the described tests above did show no performance deviations within failure limits during the stated test duration. Respective failure limits are described in the IEC60810.

For further application related information please visit www.osram-os.com/appnotes

Disclaimer

Attention please!

The information describes the type of component and shall not be considered as assured characteristics. Terms of delivery and rights to change design reserved. Due to technical requirements components may contain dangerous substances.

For information on the types in question please contact our Sales Organization.

If printed or downloaded, please find the latest version on the OSRAM OS website.

Packing

Please use the recycling operators known to you. We can also help you – get in touch with your nearest sales office. By agreement we will take packing material back, if it is sorted. You must bear the costs of transport. For packing material that is returned to us unsorted or which we are not obliged to accept, we shall have to invoice you for any costs incurred.

Product and functional safety devices/applications or medical devices/applications

OSRAM OS components are not developed, constructed or tested for the application as safety relevant component or for the application in medical devices.

OSRAM OS products are not qualified at module and system level for such application.

In case buyer – or customer supplied by buyer – considers using OSRAM OS components in product safety devices/applications or medical devices/applications, buyer and/or customer has to inform the local sales partner of OSRAM OS immediately and OSRAM OS and buyer and /or customer will analyze and coordinate the customer-specific request between OSRAM OS and buyer and/or customer.

Glossary

- 1) **Brightness:** Brightness values are measured during a current pulse of typically 25 ms, with an internal reproducibility of $\pm 8\%$ and an expanded uncertainty of $\pm 11\%$ (acc. to GUM with a coverage factor of $k = 3$).
- 2) **Reverse Operation:** Reverse Operation of 10 hours is permissible in total. Continuous reverse operation is not allowed.
- 3) **Wavelength:** The wavelength is measured at a current pulse of typically 25 ms, with an internal reproducibility of ± 0.5 nm and an expanded uncertainty of ± 1 nm (acc. to GUM with a coverage factor of $k = 3$).
- 4) **Forward Voltage:** The forward voltage is measured during a current pulse of typically 8 ms, with an internal reproducibility of ± 0.05 V and an expanded uncertainty of ± 0.1 V (acc. to GUM with a coverage factor of $k = 3$).
- 5) **Thermal Resistance:** $R_{th\ max}$ is based on statistic values (6σ).
- 6) **Typical Values:** Due to the special conditions of the manufacturing processes of semiconductor devices, the typical data or calculated correlations of technical parameters can only reflect statistical figures. These do not necessarily correspond to the actual parameters of each single product, which could differ from the typical data and calculated correlations or the typical characteristic line. If requested, e.g. because of technical improvements, these typ. data will be changed without any further notice.
- 7) **Characteristic curve:** In the range where the line of the graph is broken, you must expect higher differences between single devices within one packing unit.
- 8) **Tolerance of Measure:** Unless otherwise noted in drawing, tolerances are specified with ± 0.1 and dimensions are specified in mm.
- 9) **Tape and Reel:** All dimensions and tolerances are specified acc. IEC 60286-3 and specified in mm.

Revision History

| Version | Date | Change |
|---------|------------|--------------|
| 1.4 | 2019-07-16 | Discontinued |

Published by OSRAM Opto Semiconductors GmbH EU RoHS and China RoHS compliant product
Leibnizstraße 4, D-93055 Regensburg
www.osram-os.com © All Rights Reserved.



此产品符合欧盟 RoHS 指令的要求；
按照中国的相关法规和标准，不含有毒有害物质或元素。