

DV 4114 N

# DC diagonal compact fan

sickle-shaped blades (S series)



## ebm-papst St. Georgen GmbH & Co. KG

Hermann-Papst-Str. 1

D-78112 St. Georgen

Phone +49 (0) 7724 81-0

Fax +49 (0) 7724 81-1309

info2@de.ebmpapst.com

www.ebmpapst.com

## Nominal data

Type	DV 4114 N	
Nominal voltage	VDC	24
Nominal voltage range	VDC	16 .. 30
Speed (rpm)	min <sup>-1</sup>	6000
Power consumption	W	20.5
Min. ambient temperature	°C	-20
Max. ambient temperature	°C	65
Air flow	m <sup>3</sup> /h	280
Sound power level	B	6.9
Sound pressure level	dB(A)	61

ml = Max. load · me = Max. efficiency · fa = Free air · cs = Customer specification · ce = Customer equipment  
Subject to change



## Technical description

<b>General description</b>	* Power consumption when wide open; these values may be considerably higher at the operating point.
<b>Housing material</b>	Glass-fiber reinforced PBT plastic
<b>Impeller material</b>	Glass-fiber reinforced PA plastic
<b>Weight</b>	0.375 kg
<b>Dimensions</b>	119 x 119 x 38 mm
<b>Airflow direction</b>	Exhaust over struts
<b>Direction of rotation</b>	Counterclockwise, viewed toward rotor
<b>Storage</b>	Ball bearing
<b>Service life L10 at 40 °C</b>	70000 h
<b>Service life L10 at maximum temperature</b>	40000 h
<b>Cable</b>	Leads AWG 22, TR 64, stripped and tin-plated.
<b>Motor protection</b>	Protection against reverse polarity and blocked rotor.
<b>Locked-rotor protection</b>	With electronic locked-rotor and overload protection
<b>Approval</b>	VDE, CSA, UL, CE
<b>Option</b>	Speed signal

DV 4114 N

# DC diagonal compact fan

sickle-shaped blades (S series)

## Product drawing

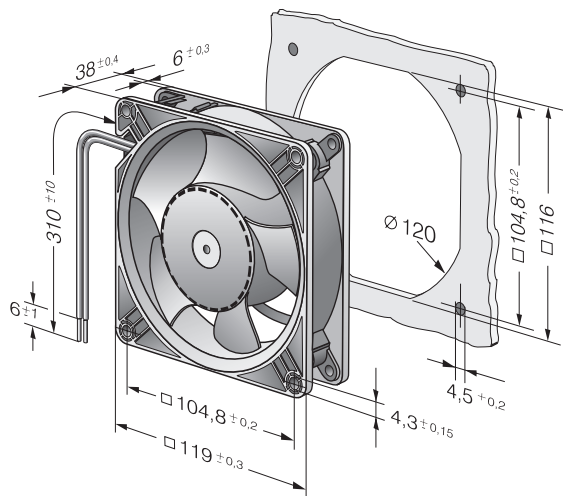

**Curves: Air performance**

