

REVISIONS

P	LTR	DESCRIPTION	DATE	DWN	APVD
A		FIRST RELEASE	02APR2019	L.C	D.Z
A1		REVISED PER ECR-21-117971	09NOV2021	SK	DZ

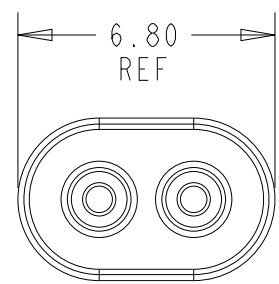

1-2 POSITION

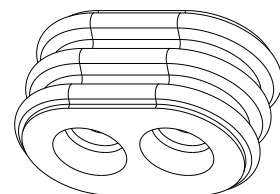

2321922-2

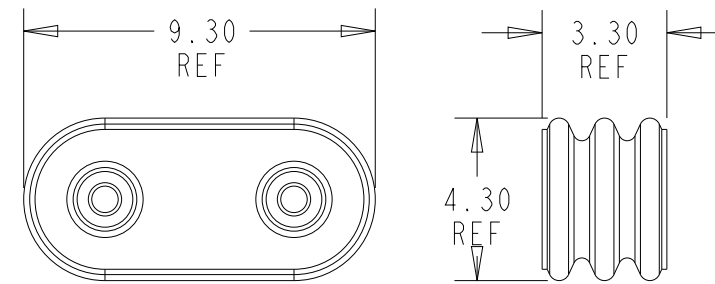

1-2 POSITION

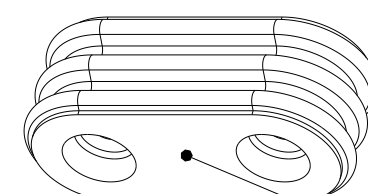

1-2321922-3 CENTER CAVITY BLOCKED

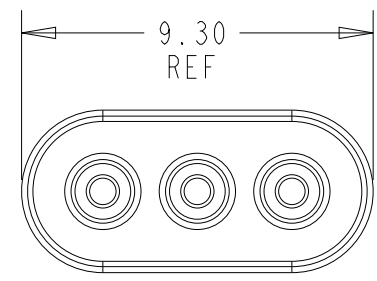

1-3 POSITION

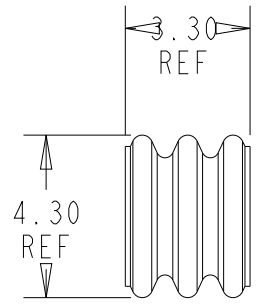

2321922-3

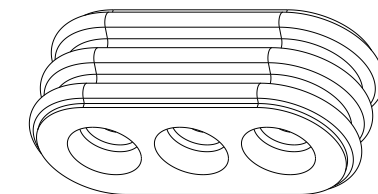

1 MATERIAL: SILICONE RUBBER, INHERENTLY LUBRICATED  
COLOR: BLUE

2. FOR USE WITH 26 TO 22 AWG WIRE, INSULATION DIAMETER 1.30-1.60mm

3. MATING CONNECTOR P/N'S:  
CAP HSG - 2321926-\*/2321924-\*/2329544-  
PLUG HSG - 2321918-\*/2329541-\*

4 PRELIMINARY PART - NOT RELEASED FOR PRODUCTION

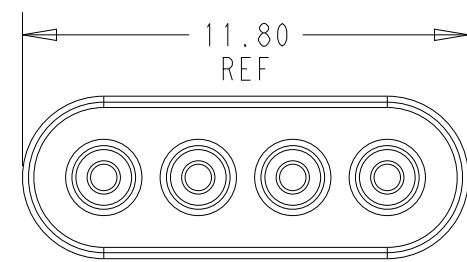

1-4 POSITION

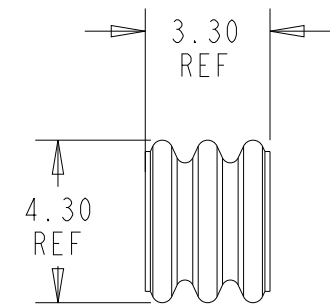

2321922-4

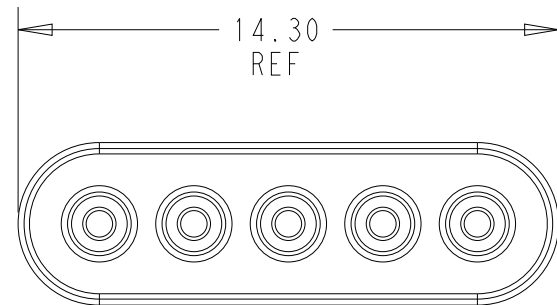
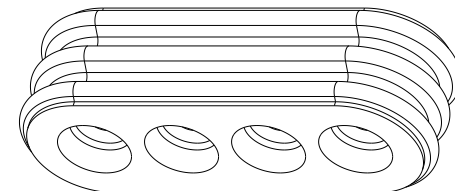

1-5 POSITION

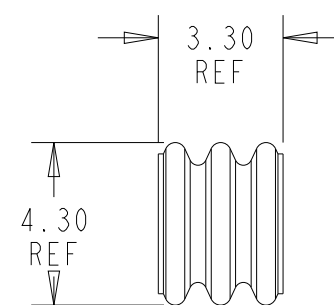

2321922-5

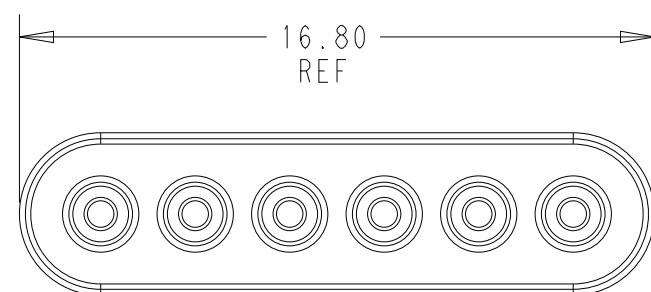
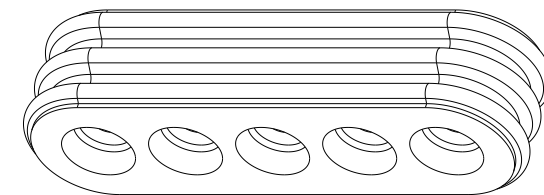

1-6 POSITION

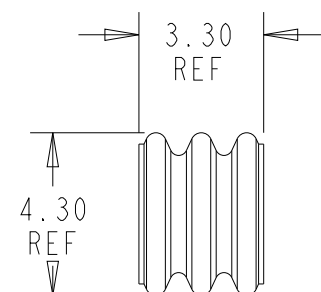

2321922-6

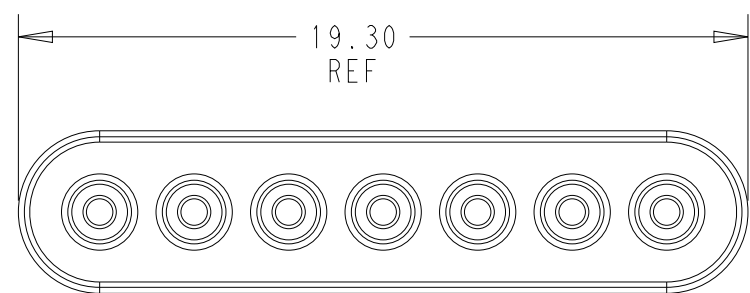
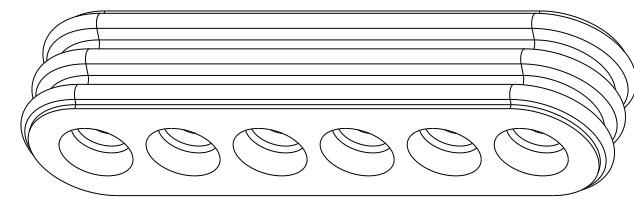

1-7 POSITION

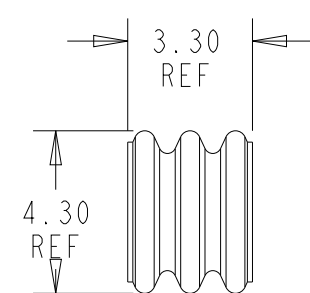

2321922-7

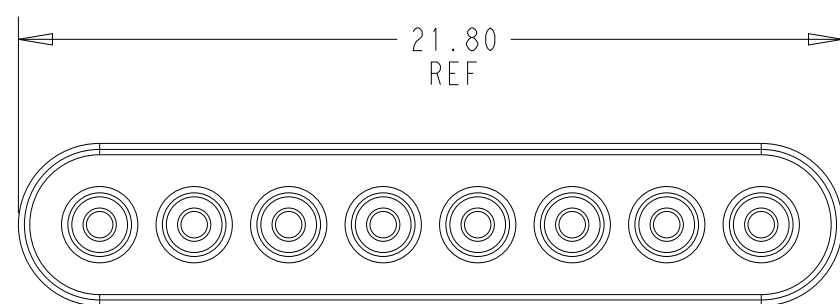
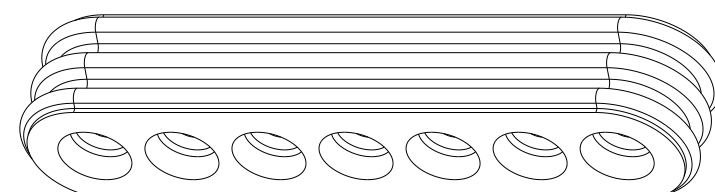

1-8 POSITION

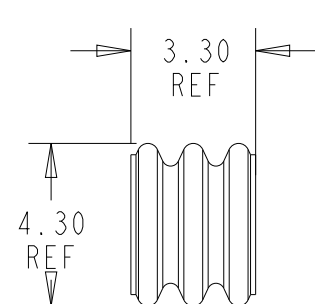

2321922-8

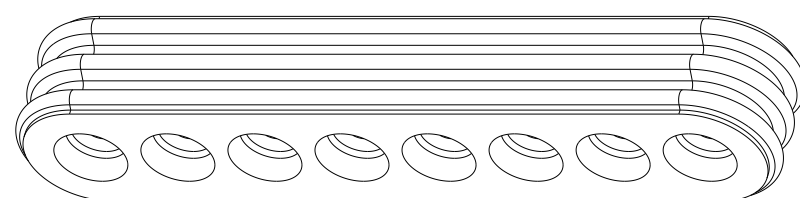

1*2	1-2321922-3
1*8	4 2321922-8
1*7	4 2321922-7
1*6	2321922-6
1*5	2321922-5
1*4	2321922-4
1*3	2321922-3
1*2	2321922-2
POSITIONS	PART NUMBER

THIS DRAWING IS A CONTROLLED DOCUMENT.

DWN B. WEAVER 01FEB2019  
CHK C. YI 01FEB2019  
APVD C. YI 01FEB2019

STE TE Connectivity

DIMENSIONS:	TOLERANCES UNLESS OTHERWISE SPECIFIED:
mm	0 PLC ± 1 PLC ± 2 PLC ± 3 PLC ± 4 PLC ± ANGLES ± FINISH -

PRODUCT SPEC 108-143069  
APPLICATION SPEC 114-143067  
WEIGHT -  
CUSTOMER DRAWING

NAME		RESTRICTED TO	
REAR GANG SEAL, SDL 2.5 WATERPROOF		-	
SIZE	CAGE CODE	DRAWING NO	REV
A2	00779	C-2321922	A1

SCALE 5:1 SHEET 1 OF 1