



Is Now Part of



**ON Semiconductor®**

To learn more about ON Semiconductor, please visit our website at  
[www.onsemi.com](http://www.onsemi.com)

Please note: As part of the Fairchild Semiconductor integration, some of the Fairchild orderable part numbers will need to change in order to meet ON Semiconductor's system requirements. Since the ON Semiconductor product management systems do not have the ability to manage part nomenclature that utilizes an underscore (\_), the underscore (\_) in the Fairchild part numbers will be changed to a dash (-). This document may contain device numbers with an underscore (\_). Please check the ON Semiconductor website to verify the updated device numbers. The most current and up-to-date ordering information can be found at [www.onsemi.com](http://www.onsemi.com). Please email any questions regarding the system integration to [Fairchild\\_questions@onsemi.com](mailto:Fairchild_questions@onsemi.com).

ON Semiconductor and the ON Semiconductor logo are trademarks of Semiconductor Components Industries, LLC dba ON Semiconductor or its subsidiaries in the United States and/or other countries. ON Semiconductor owns the rights to a number of patents, trademarks, copyrights, trade secrets, and other intellectual property. A listing of ON Semiconductor's product/patent coverage may be accessed at [www.onsemi.com/site/pdf/Patent-Marking.pdf](http://www.onsemi.com/site/pdf/Patent-Marking.pdf). ON Semiconductor reserves the right to make changes without further notice to any products herein. ON Semiconductor makes no warranty, representation or guarantee regarding the suitability of its products for any particular purpose, nor does ON Semiconductor assume any liability arising out of the application or use of any product or circuit, and specifically disclaims any and all liability, including without limitation special, consequential or incidental damages. Buyer is responsible for its products and applications using ON Semiconductor products, including compliance with all laws, regulations and safety requirements or standards, regardless of any support or applications information provided by ON Semiconductor. "Typical" parameters which may be provided in ON Semiconductor data sheets and/or specifications can and do vary in different applications and actual performance may vary over time. All operating parameters, including "Typicals" must be validated for each customer application by customer's technical experts. ON Semiconductor does not convey any license under its patent rights nor the rights of others. ON Semiconductor products are not designed, intended, or authorized for use as a critical component in life support systems or any FDA Class 3 medical devices or medical devices with a same or similar classification in a foreign jurisdiction or any devices intended for implantation in the human body. Should Buyer purchase or use ON Semiconductor products for any such unintended or unauthorized application, Buyer shall indemnify and hold ON Semiconductor and its officers, employees, subsidiaries, affiliates, and distributors harmless against all claims, costs, damages, and expenses, and reasonable attorney fees arising out of, directly or indirectly, any claim of personal injury or death associated with such unintended or unauthorized use, even if such claim alleges that ON Semiconductor was negligent regarding the design or manufacture of the part. ON Semiconductor is an Equal Opportunity/Affirmative Action Employer. This literature is subject to all applicable copyright laws and is not for resale in any manner.



ON Semiconductor®

April 2017

# FNF51560TD1

## Motion SPM® 55 Series

### Features

- UL Certified No. E209204 (UL1557)
- 600 V - 15 A 3-Phase IGBT Inverter Including Control IC for Gate Drive and Protections
- Low-Loss, Short-Circuit Rated IGBTs
- Built-In Bootstrap Diodes in HVIC
- Separate Open-Emitter Pins from Low-Side IGBTs for Three-Phase Current Sensing
- Active-HIGH interface, works with 3.3 / 5 V Logic, Schmitt-trigger Input
- HVIC for Gate Driving, Under-Voltage and Short-Circuit Current Protection
- Fault Output for Under-Voltage and Short-Circuit Current Protection
- Inter-Lock Function to Prevent Short-Circuit
- Shut-Down Input
- HVIC Temperature-Sensing Built-In for Temperature Monitoring
- Optimized for 15 kHz Switching Frequency
- Isolation Rating: 1500 V<sub>rms</sub> / min.

### Applications

- Motion Control - Home Appliance / Industrial Motor

### Related Resources

- [AN-9096 - Smart Power Module, Motion SPM® 55 Series User's Guide](#)
- [AN-9097 - SPM® 55 Packing Mounting Guidance](#)

### General Description

FNF51560TD1 is a Motion SPM 55 module providing a fully-featured, high-performance inverter output stage for AC Induction, BLDC, and PMSM motors. These modules integrate optimized gate drive of the built-in IGBTs to minimize EMI and losses, while also providing multiple on-module protection features including under-voltage lockouts, inter-lock function, over-current shutdown, thermal monitoring of drive IC, and fault reporting. The built-in, high-speed HVIC requires only a single supply voltage and translates the incoming logic-level gate inputs to the high-voltage, high-current drive signals required to properly drive the module's robust short-circuit-rated IGBTs. Separate negative IGBT terminals are available for each phase to support the widest variety of control algorithms.



Figure 1. 3D Package Drawing  
(Click to Activate 3D Content)

### Package Marking and Ordering Information

Device	Device Marking	Package	Packing Type	Quantity
FNF51560TD1	FNF51560TD1	SPMFA-A20	RAIL	13

### Integrated Power Functions

- 600 V - 15 A IGBT inverter for three phase DC / AC power conversion (Please refer to Figure 3)

### Integrated Drive, Protection and System Control Functions

- For inverter high-side IGBTs: gate drive circuit, high-voltage isolated high-speed level shifting control circuit Under-Voltage Lock-Out (UVLO) protection
- For inverter low-side IGBTs: gate drive circuit, Short-Circuit Protection (SCP) control supply circuit Under-Voltage Lock-Out (UVLO) protection
- Fault signaling: corresponding to UVLO (low-side supply) and SC faults
- Input interface: High-active interface, works with 3.3 / 5 V logic, Schmitt trigger input
- Built in Bootstrap circuitry in HVIC

### Pin Configuration

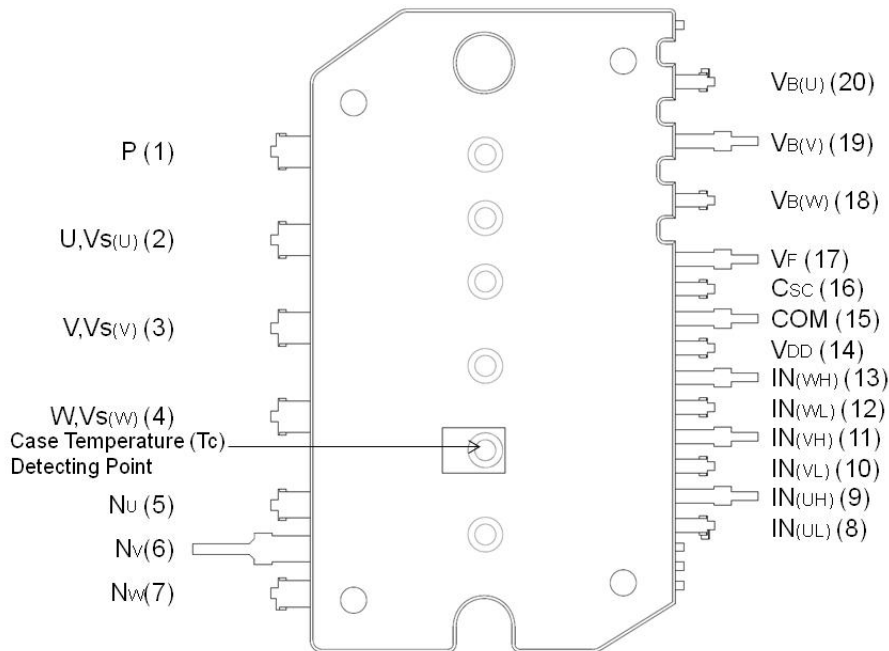
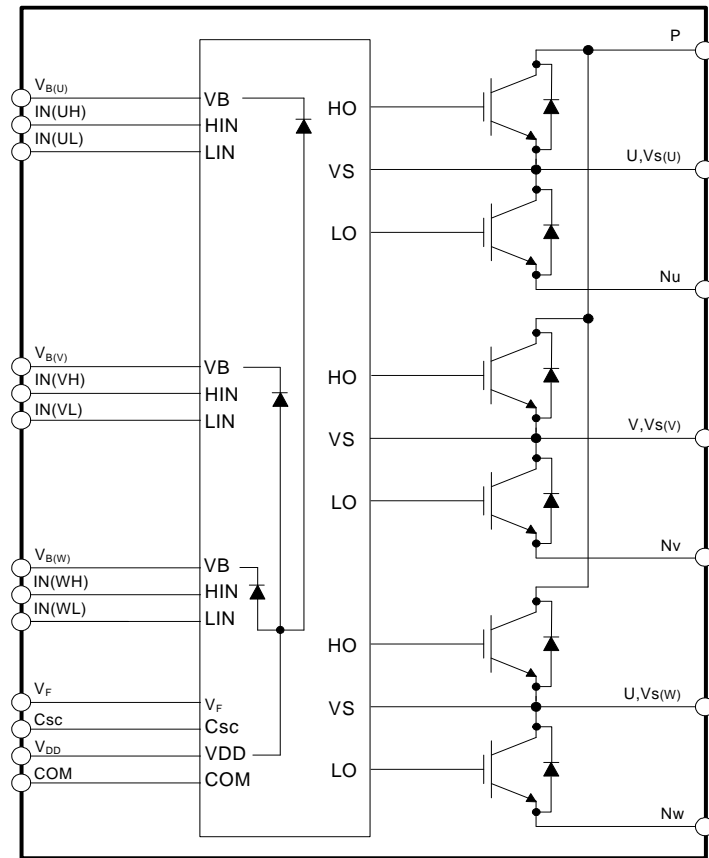

Figure 2. Top View

## Pin Descriptions

Pin Number	Pin Name	Pin Description
1	P	Positive DC-Link Input
2	U, $V_S(U)$	Output for U Phase
3	V, $V_S(V)$	Output for V Phase
4	W, $V_S(W)$	Output for W Phase
5	$N_U$	Negative DC-Link Input for U Phase
6	$N_V$	Negative DC-Link Input for V Phase
7	$N_W$	Negative DC-Link Input for W Phase
8	$IN_{(UL)}$	Signal Input for Low-Side U Phase
9	$IN_{(UH)}$	Signal Input for High-Side U Phase
10	$IN_{(VL)}$	Signal Input for Low-Side V Phase
11	$IN_{(VH)}$	Signal Input for High-Side V Phase
12	$IN_{(WL)}$	Signal Input for Low-Side W Phase
13	$IN_{(WH)}$	Signal Input for High-Side W Phase
14	$V_{DD}$	Common Bias Voltage for IC and IGBTs Driving
15	COM	Common Supply Ground
16	$C_{SC}$	Capacitor (Low-Pass Filter) for Short-circuit Current Detection Input
17	$V_F$	Fault Output, Shut-Down Input, Temperature Output of Drive IC
18	$V_{B(W)}$	High-Side Bias Voltage for W-Phase IGBT Driving
19	$V_{B(V)}$	High-Side Bias Voltage for V-Phase IGBT Driving
20	$V_{B(U)}$	High-Side Bias Voltage for U-Phase IGBT Driving

### Internal Equivalent Circuit and Input/Output Pins



**Figure 3. Internal Block Diagram**

**Note:**

1. Inverter high-side is composed of three IGBTs, freewheeling diodes, and one control IC for each IGBT.
2. Inverter low-side is composed of three IGBTs, freewheeling diodes, and one control IC for each IGBT. It has gate drive and protection functions.
3. Single drive IC has gate driver for six IGBTs and protection functions.
4. Inverter power side is composed of four inverter DC-link input terminals and three inverter output terminals.

## Absolute Maximum Ratings ( $T_J = 25^\circ\text{C}$ , unless otherwise specified.)

### Inverter Part

Symbol	Parameter	Conditions	Rating	Unit
$V_{PN}$	Supply Voltage	Applied between P - $N_U, N_V, N_W$	450	V
$V_{PN(\text{Surge})}$	Supply Voltage (Surge)	Applied between P - $N_U, N_V, N_W$	500	V
$V_{CES}$	Collector - Emitter Voltage		600	V
* $\pm I_C$	Each IGBT Collector Current	$T_C = 25^\circ\text{C}, T_J < 150^\circ\text{C}$	15	A
* $\pm I_{CP}$	Each IGBT Collector Current (Peak)	$T_C = 25^\circ\text{C}, T_J < 150^\circ\text{C}$ , Under 1 ms Pulse Width	30	A
* $P_C$	Collector Dissipation	$T_C = 25^\circ\text{C}$ per Chip	22	W
$T_J$	Operating Junction Temperature	(Note 5)	-40 ~ 150	$^\circ\text{C}$

**Note:**

5. The maximum junction temperature rating of the power chips integrated within the Motion SPM® 55 product is 150°C.

### Control Part

Symbol	Parameter	Conditions	Rating	Unit
$V_{DD}$	Control Supply Voltage	Applied between $V_{DD}$ - COM	20	V
$V_{BS}$	High-Side Control Bias Voltage	Applied between $V_{B(U)} - V_{S(U)}, V_{B(V)} - V_{S(V)}, V_{B(W)} - V_{S(W)}$	20	V
$V_{IN}$	Input Signal Voltage	Applied between $IN_{(UH)}, IN_{(VH)}, IN_{(WH)}, IN_{(UL)}, IN_{(VL)}, IN_{(WL)}$ - COM	-0.3 ~ $V_{DD} + 0.3$	V
$V_F$	Fault Supply Voltage	Applied between $V_F$ - COM	-0.3 ~ $V_{DD} + 0.3$	V
* $I_F$	Fault Current	Sink Current at $V_F$ pin	5	mA
$V_{SC}$	Current Sensing Input Voltage	Applied between $C_{SC}$ - COM	-0.3 ~ $V_{DD} + 0.3$	V

### Total System

Symbol	Parameter	Conditions	Rating	Unit
$V_{PN(\text{PROT})}$	Self Protection Supply Voltage Limit (Short Circuit Protection Capability)	$V_{DD} = V_{BS} = 13.5 \sim 16.5 \text{ V}$ $T_J = 150^\circ\text{C}$ , Non-Repetitive, $< 2 \mu\text{s}$	400	V
$T_{STG}$	Storage Temperature		-40 ~ 125	$^\circ\text{C}$
$V_{ISO}$	Isolation Voltage Connect Pins to Heat Sink Plate	AC 60 Hz, Sinusoidal, 1 Minute	1500	$V_{\text{rms}}$

### Thermal Resistance

Symbol	Parameter	Conditions	Min.	Typ.	Max.	Unit
$R_{th(j-c)Q}$	Junction to Case Thermal Resistance (Note 7)	Inverter IGBT part (per 1 / 6 module)	-	-	5.6	$^\circ\text{C} / \text{W}$
$R_{th(j-c)F}$		Inverter FWD part (per 1 / 6 module)	-	-	6.9	$^\circ\text{C} / \text{W}$

**Note:**

6. For Marking "\*\*", These Value had been made an acquisition by the calculation considered to design factor.

7. For the measurement point of case temperature ( $T_C$ ), please refer to Figure 2.

**Electrical Characteristics** ( $T_J = 25^\circ\text{C}$ , unless otherwise specified.)

**Inverter Part**

Symbol	Parameter	Conditions	Min.	Typ.	Max.	Unit		
$V_{CE(SAT)}$	Collector - Emitter Saturation Voltage	$V_{DD} = V_{BS} = 15\text{ V}$ $V_{IN} = 5\text{ V}$ $I_C = 10\text{ A}$	$T_J = 25^\circ\text{C}$	-	1.9	2.2	V	
			$T_J = 150^\circ\text{C}$	-	2.4	-	V	
$V_F$	FWDi Forward Voltage	$V_{IN} = 0\text{ V}$ $I_F = 10\text{ A}$	$T_J = 25^\circ\text{C}$	-	2.0	2.45	V	
			$T_J = 150^\circ\text{C}$	-	1.9	-	V	
HS	$t_{ON}$	Switching Times	$V_{PN} = 400\text{ V}, V_{DD} = V_{BS} = 15\text{ V}, I_C = 15\text{ A}$ $T_J = 25^\circ\text{C}$ $V_{IN} = 0\text{ V} \leftrightarrow 5\text{ V}$ , Inductive load (Note 8)	0.40	0.60	0.80	us	
				$t_{C(ON)}$	-	0.20	0.30	us
				$t_{OFF}$	-	0.50	0.70	us
				$t_{C(OFF)}$	-	0.10	0.20	us
				$t_{rr}$	-	0.04	-	us
LS	$t_{ON}$	Switching Times	$V_{PN} = 400\text{ V}, V_{DD} = V_{BS} = 15\text{ V}, I_C = 15\text{ A}$ $T_J = 25^\circ\text{C}$ $V_{IN} = 0\text{ V} \leftrightarrow 5\text{ V}$ , Inductive load (Note 8)	0.40	0.60	0.80	us	
				$t_{C(ON)}$	-	0.20	0.30	us
				$t_{OFF}$	-	0.50	0.70	us
				$t_{C(OFF)}$	-	0.10	0.20	us
				$t_{rr}$	-	0.04	-	us
$I_{CES}$	Collector - Emitter Leakage Current	$V_{CE} = V_{CES}$	-	-	1	mA		

**Note:**

8.  $t_{ON}$  and  $t_{OFF}$  include the propagation delay of the internal drive IC.  $t_{C(ON)}$  and  $t_{C(OFF)}$  are the switching time of IGBT itself under the given gate driving condition internally. For the detailed information, please see Figure 4.

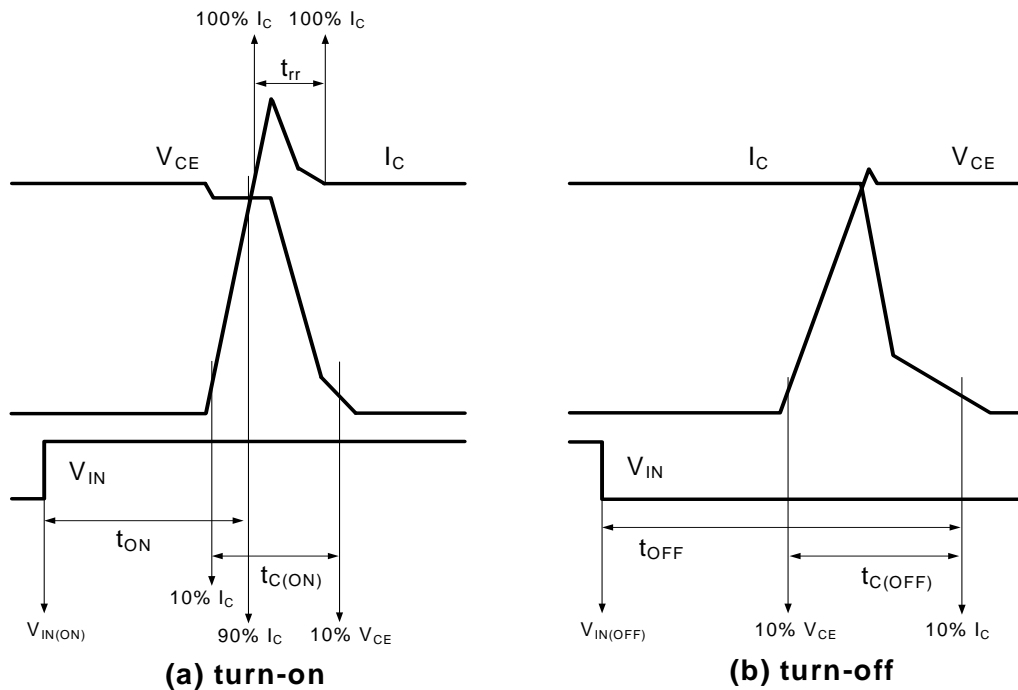

**Figure 4. Switching Time Definition**

**Control Part**

Symbol	Parameter	Conditions	Min.	Typ.	Max.	Unit	
$I_{QDD}$	Quiescent $V_{DD}$ Supply Current	$V_{DD} = 15\text{ V}$ , $I_{N(UH, VH, WH, UL, VL, WL)} = 0\text{ V}$	$V_{DD} - \text{COM}$	-	1.5	2.0	mA
$I_{PDD}$	Operating $V_{DD}$ Supply Current	$V_{DD} = 15\text{ V}$ , $f_{PWM} = 20\text{ kHz}$ , duty = 50%, applied to one PWM signal input	$V_{DD} - \text{COM}$	-	1.8	2.5	mA
$I_{QBS}$	Quiescent $V_{BS}$ Supply Current	$V_{BS} = 15\text{ V}$ , $I_{N(UH, VH, WH)} = 0\text{ V}$	$V_{B(U)} - V_{S(U)}$ , $V_{B(V)} - V_{S(V)}$ , $V_{B(W)} - V_{S(W)}$	-	30	55	$\mu\text{A}$
$I_{PBS}$	Operating $V_{BS}$ Supply Current	$V_{DD} = V_{BS} = 15\text{ V}$ , $f_{PWM} = 20\text{ kHz}$ , duty = 50%, applied to one PWM signal input for high - side	$V_{B(U)} - V_{S(U)}$ , $V_{B(V)} - V_{S(V)}$ , $V_{B(W)} - V_{S(W)}$	-	330	450	$\mu\text{A}$
$V_{FH}$	Fault Output Voltage	$V_{SC} = 0\text{ V}$ , $V_F$ Circuit: 10 k $\Omega$ to 5 V Pull-up	4.5	-	-	V	
$V_{FL}$		$V_{SC} = 1\text{ V}$ , $V_F$ Circuit: 10 k $\Omega$ to 5 V Pull-up	-	-	0.5	V	
$V_{SC(ref)}$	Short-Circuit Trip Level	$V_{DD} = 15\text{ V}$ (Note 4)	0.45	0.5	0.55	V	
$UV_{DDD}$	Supply Circuit Under-Voltage Protection	Detection level	10.7	11.4	12.1	V	
$UV_{DDR}$		Reset level	11.2	12.3	13.0	V	
$UV_{BSD}$		Detection level	10.1	10.8	11.5	V	
$UV_{BSR}$		Reset level	10.7	11.4	12.1	V	
$I_{FT}$	HVIC Temperature Sensing Current	$V_{DD} = V_{BS} = 15\text{ V}$ , $T_{HVIC} = 25^\circ\text{C}$	68	81	95	$\mu\text{A}$	
$V_{FT}$	HVIC Temperature Sensing Voltage	$V_{DD} = V_{BS} = 15\text{ V}$ , $T_{HVIC} = 25^\circ\text{C}$ , 10 k $\Omega$ to 5 V Pull-up (Figure. 5)	4.05	4.19	4.32	V	
$t_{FOD}$	Fault-Out Pulse Width		40	120	-	$\mu\text{s}$	
$V_{FSDR}$	Shut-down Reset level	Applied between $V_F - \text{COM}$	-	-	2.4	V	
$V_{FSDD}$	Shut-down Detection level		0.8	-	-	V	
$V_{IN(ON)}$	ON Threshold Voltage	Applied between $I_{N(UH)}$ , $I_{N(VH)}$ , $I_{N(WH)}$ , $I_{N(UL)}$ , $I_{N(VL)}$ , $I_{N(WL)} - \text{COM}$	-	-	2.4	V	
$V_{IN(OFF)}$	OFF Threshold Voltage		0.8	-	-	V	

**Note:**

9. Short-circuit protection is functioning for all six IGBTs.

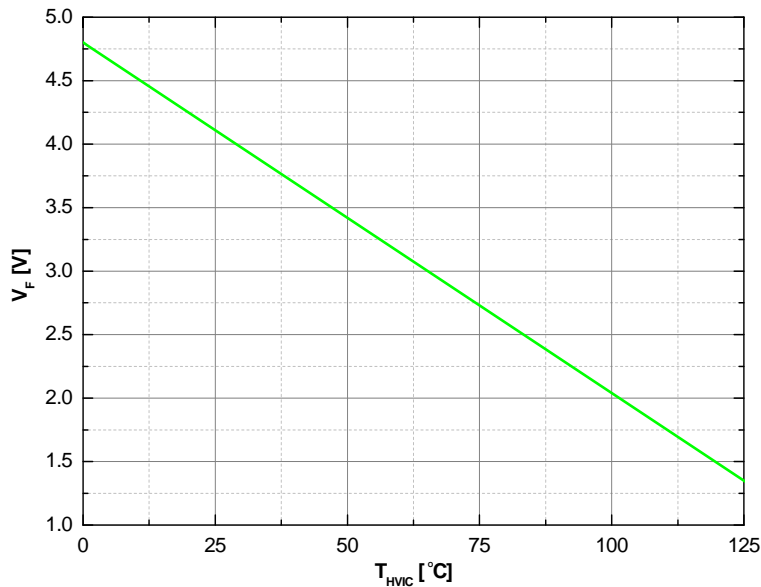

**Figure. 5. V-T Curve of Temperature Output of IC (5V pull-up with 10kohm)**



### Bootstrap Diode Part

Symbol	Parameter	Conditions	Min.	Typ.	Max.	Unit
$R_{BS}$	Bootstrap Diode Resitance	$V_{DD} = 15V, T_J = 25^{\circ}C$	-	280	-	$\Omega$

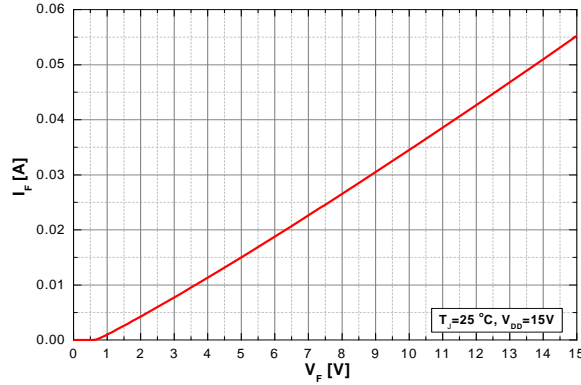

Figure 6. Built-In Bootstrap Diode Charateristics

### Recommended Operating Conditions

Symbol	Parameter	Conditions	Min.	Typ.	Max.	Unit
$V_{PN}$	Supply Voltage	Applied between P - $N_U, N_V, N_W$	-	300	400	V
$V_{DD}$	Control Supply Voltage	Applied between $V_{DD}$ - COM	14.0	15	16.5	V
$V_{BS}$	High - Side Bias Voltage	Applied between $V_{B(U)} - V_{S(U)}, V_{B(V)} - V_{S(V)}, V_{B(W)} - V_{S(W)}$	13.0	15	18.5	V
$dV_{DD} / dt, dV_{BS} / dt$	Control Supply Variation		-1	-	1	V / $\mu$ s
$t_{dead}$	Blanking Time for Preventing Arm - Short	For each input signal	0.5	-	-	$\mu$ s
$f_{PWM}$	PWM Input Signal	$-40^{\circ}C < T_J < 150^{\circ}C$	-	-	20	kHz
$V_{SEN}$	Voltage for Current Sensing	Applied between $N_U, N_V, N_W$ - COM (Including surge voltage)	-4		4	V
$P_{WIN(ON)}$	Minimum Input Pulse Width	(Note 10)	0.7	-	-	$\mu$ s
$P_{WIN(OFF)}$			0.7	-	-	

**Note:**

10. This product might not make response if input pulse width is less than the recommended value.

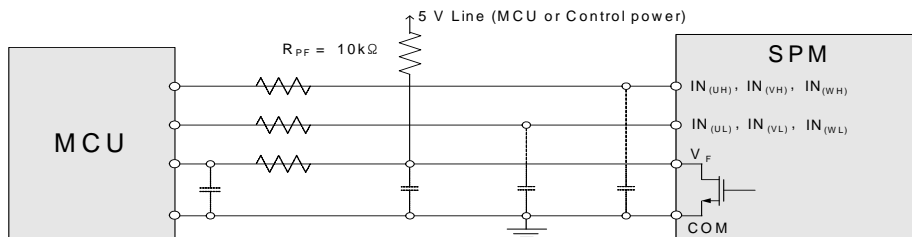

**Note:**

11. RC coupling at each input (parts shown dotted) might change depending on the PWM control scheme used in the application and the wiring impedance of the application's printed circuit board. The input signal section of the SPM 55 product integrates 10 k $\Omega$  (typ.) pull-down resistor. Therefore, when using an external filtering resistor, please pay attention to the signal voltage drop at input terminal.

Figure 7. Recommended MCU I/O Interface Circuit

### Mechanical Characteristics and Ratings

Parameter	Conditions	Min.	Typ.	Max.	Unit	
Device Flatness	See Figure 8	-50	-	100	μm	
Mounting Torque	Mounting Screw: - M3	Recommended 0.7 N • m	0.6	0.7	0.8	N • m
	Note Figure 9	Recommended 7.1 kg • cm	5.9	6.9	7.9	kg • cm
Weight		-	6.0	-	g	

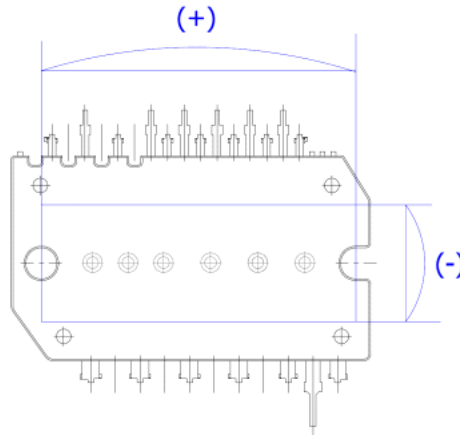

**Figure 8. Flatness Measurement Position**

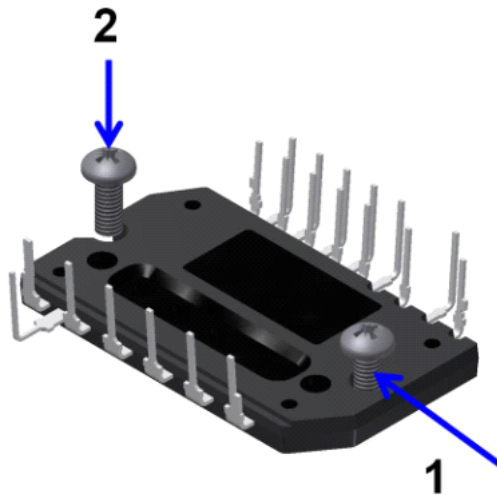
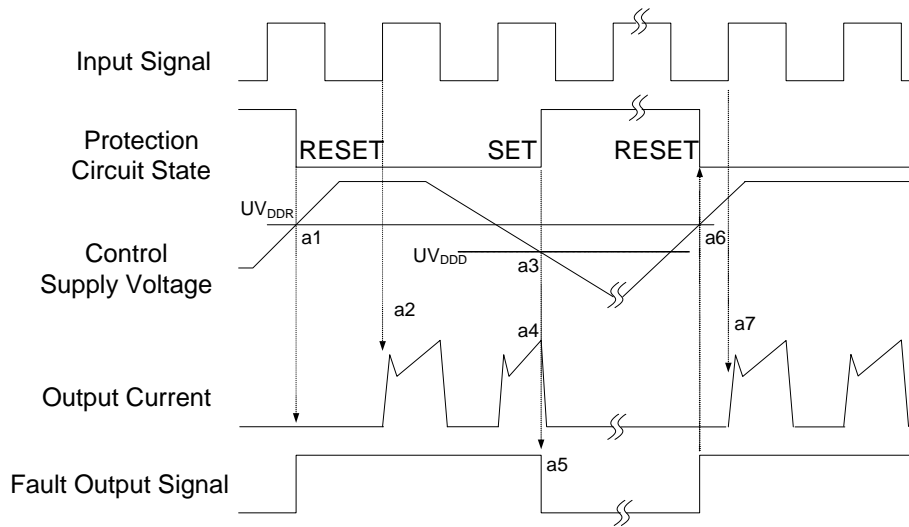

**Figure 9. Mounting Screws Torque Order**

**Note:**

- 12. Do not make over torque when mounting screws. Much mounting torque may cause package cracks, as well as bolts and Al heat-sink destruction.
- 13. Avoid one side tightening stress. Figure 11 shows the recommended torque order for mounting screws. Uneven mounting can cause the ceramic substrate of the Motion SPM 55 product to be damaged. The Pre-screwing torque is set to 20 ~ 30 % of maximum torque rating.

### Time Charts of Protective Function



- a1 : Control supply voltage rises: After the voltage rises  $UV_{DDR}$ , the circuits start to operate when next input is applied.
- a2 : Normal operation: IGBT ON and carrying current.
- a3 : Under voltage detection ( $UV_{DDD}$ ).
- a4 : IGBT OFF in spite of control input condition.
- a5 : Fault output operation starts.
- a6 : Under voltage reset ( $UV_{DDR}$ ).
- a7 : Normal operation: IGBT ON and carrying current.

**Figure 10. Under-Voltage Protection (Low-Side)**



- b1 : Control supply voltage rises: After the voltage reaches  $UV_{BSR}$ , the circuits start to operate when next input is applied.
- b2 : Normal operation: IGBT ON and carrying current.
- b3 : Under voltage detection ( $UV_{BSD}$ ).
- b4 : IGBT OFF in spite of control input condition, but there is no fault output signal.
- b5 : Under voltage reset ( $UV_{BSR}$ )
- b6 : Normal operation: IGBT ON and carrying current

**Figure 11. Under-Voltage Protection (High-Side)**

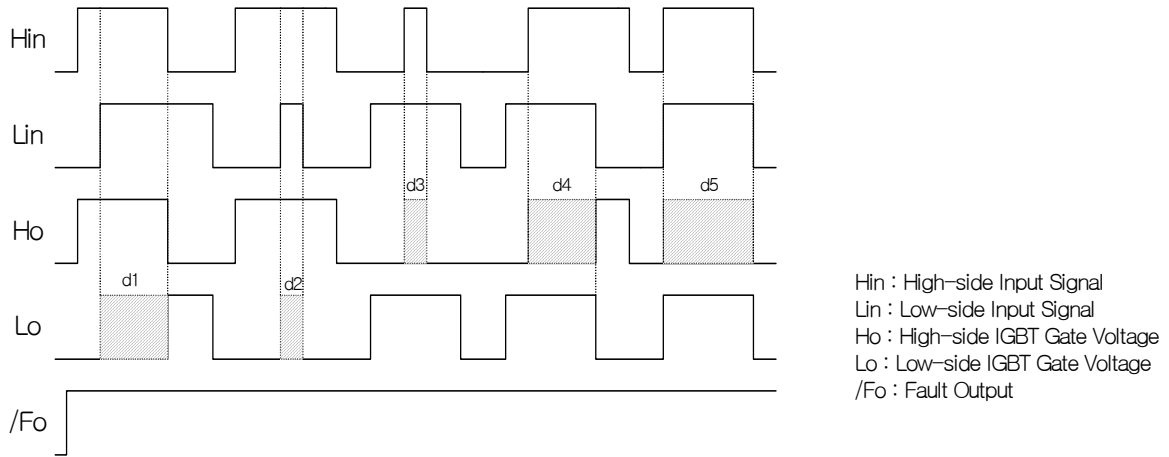

- d1 : High Side First - Input - First - Output Mode
- d2 : Low Side Noise Mode : No Lo
- d3 : High Side Noise Mode : No Ho
- d4 : Low Side First - Input - First - Output Mode
- d5 : In - Phase Mode : No Ho

**Figure 12. Inter-Lock Function**

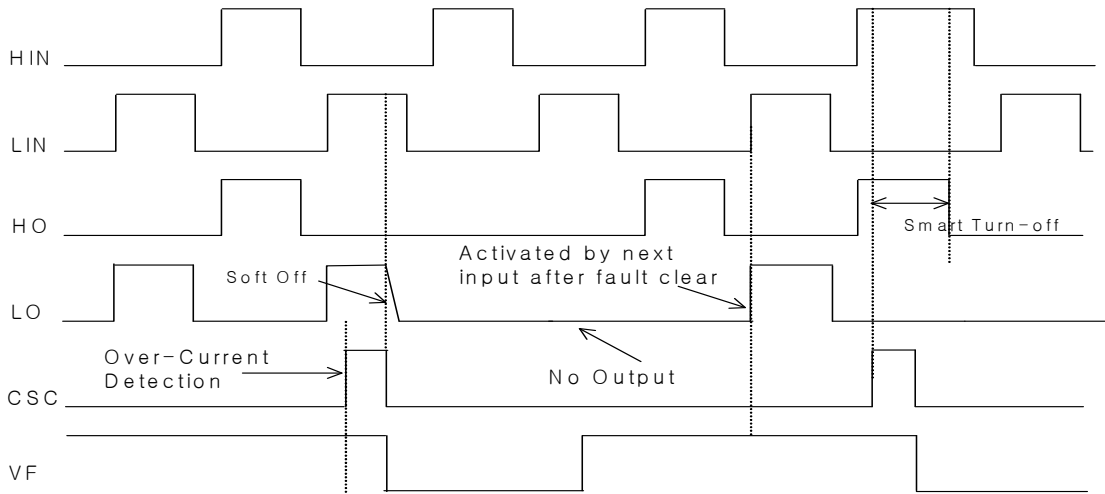

- HIN : High-side Input Signal
- LIN : Low-side Input Signal
- HO : High-Side Output Signal
- LO : Low-Side Output Signal
- CSC : Over Current Detection Input
- VF : Fault Out Function

**Figure 13. Fault-Out Function By Over Current Protection**

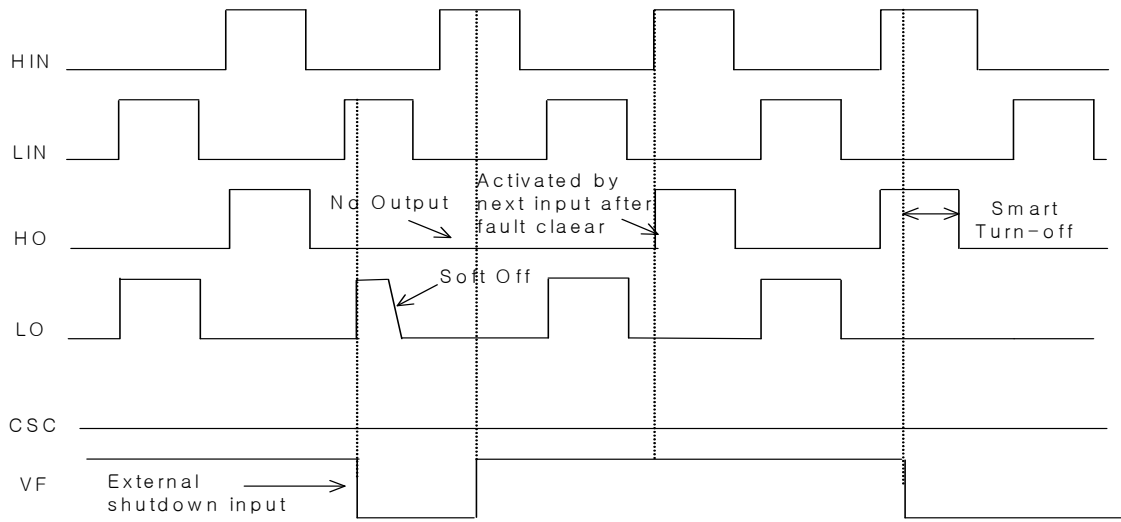

HIN : High-side Input Signal  
 LIN : Low-side Input Signal  
 HO : High-Side Output Signal  
 LO : Low-Side Output Signal  
 CSC : Over Current Detection Input  
 VF : Shutdown Input Function

**Figure 14. Shutdown Input Function By External Command**

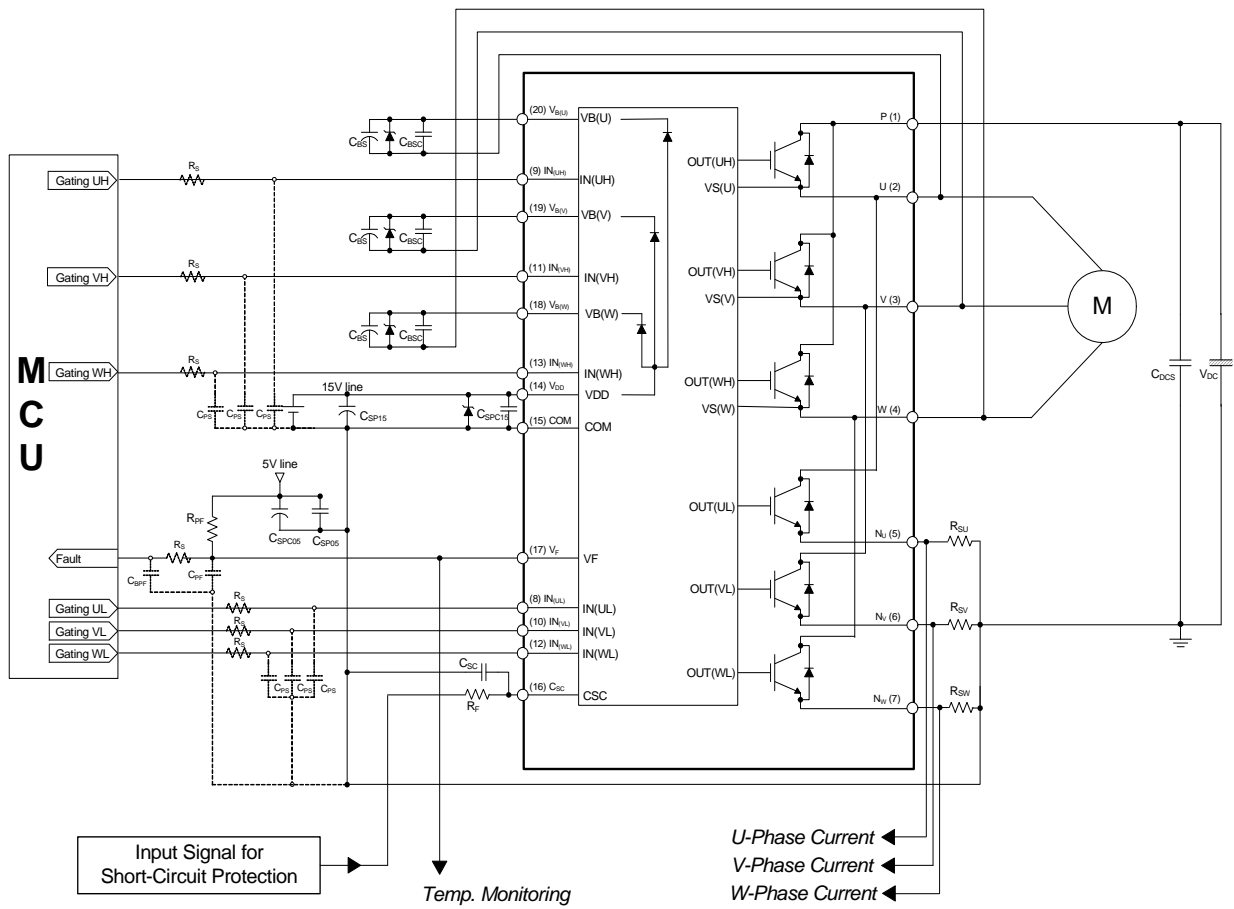

**Note:**

- 1) To avoid malfunction, the wiring of each input should be as short as possible. (less than 2 ~ 3 cm)
- 2) By virtue of integrating an application specific type of HVIC inside the SPM® 55 product, direct coupling to MCU terminals without any opto-coupler or transformer isolation is possible.
- 3)  $V_F$  is open-drain type. This signal line should be pulled up to the positive side of the MCU or control power supply with a resistor that makes  $I_{FO}$  up to 5 mA. Please refer to Figure 15.
- 4)  $C_{SP15}$  of around seven times larger than bootstrap capacitor  $C_{BS}$  is recommended.
- 5) Input signal is active-HIGH type. There is a 10 kΩ resistor inside the IC to pull down each input signal line to GND. RC coupling circuits is recommended for the prevention of input signal oscillation.  $R_{SCPS}$  time constant should be selected in the range 50 ~ 150 ns. (Recommended  $R_S = 100 \Omega$ ,  $C_{PS} = 1$  nF)
- 6) To prevent errors of the protection function, the wiring around  $R_F$  and  $C_{SC}$  should be as short as possible.
- 7) In the short-circuit protection circuit, please select the  $R_F C_{SC}$  time constant in the range 1.5 ~ 2 μs.
- 8) The connection between control GND line and power GND line which includes the  $N_U$ ,  $N_V$ ,  $N_W$  must be connected to only one point. Please do not connect the control GND to the power GND by the broad pattern. Also, the wiring distance between control GND and power GND should be as short as possible.
- 9) Each capacitor should be mounted as close to the pins of the Motion SPM 55 product as possible.
- 10) To prevent surge destruction, the wiring between the smoothing capacitor and the P and GND pins should be as short as possible. The use of a high frequency non-inductive capacitor of around 0.1 ~ 0.22 μF between the P and GND pins is recommended.
- 11) Relays are used at almost every systems of electrical equipments of home appliances. In these cases, there should be sufficient distance between the CPU and the relays.
- 12) The zener diode or transient voltage suppressor should be adopted for the protection of ICs from the surge destruction between each pair of control supply terminals. (Recommended zener diode is 22 V / 1 W, which has the lower zener impedance characteristic than about 15 Ω)
- 13) Please choose the electrolytic capacitor with good temperature characteristic in  $C_{BS}$ . Also, choose 0.1 ~ 0.2 μF R-category ceramic capacitors with good temperature and frequency characteristics in  $C_{BSC}$ .
- 14) For the detailed information, please refer to the application notes.

**Figur15. Typical Application Circuit**

### Detailed Package Outline Drawings (FNF51560TD1, Short Lead)

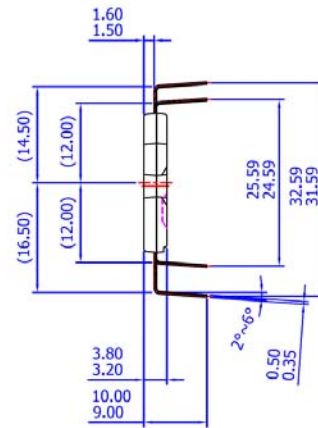
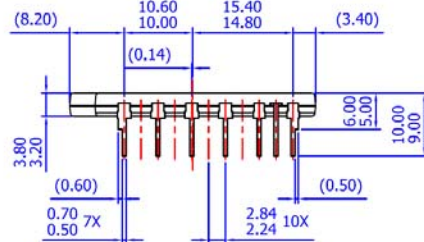
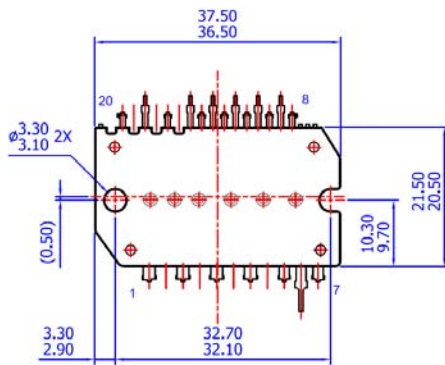
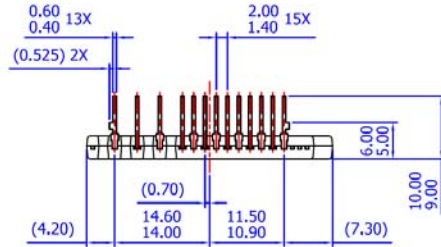

- NOTES: UNLESS OTHERWISE SPECIFIED
- A) THIS PACKAGE DOES NOT COMPLY TO ANY CURRENT PACKAGING STANDARD
  - B) ALL DIMENSIONS ARE IN MILLIMETERS
  - C) DIMENSIONS ARE EXCLUSIVE OF BURRS, MOLD FLASH, AND TIE BAR EXTRUSIONS
  - D) ( ) IS REFERENCE
  - E) [ ] IS ASS'Y QUALITY
  - F) DRAWING FILENAME: MOD20DBREV2

ON Semiconductor and the ON Semiconductor logo are trademarks of Semiconductor Components Industries, LLC dba ON Semiconductor or its subsidiaries in the United States and/or other countries. ON Semiconductor owns the rights to a number of patents, trademarks, copyrights, trade secrets, and other intellectual property. A listing of ON Semiconductor's product/patent coverage may be accessed at [www.onsemi.com/site/pdf/Patent-Marking.pdf](http://www.onsemi.com/site/pdf/Patent-Marking.pdf). ON Semiconductor reserves the right to make changes without further notice to any products herein. ON Semiconductor makes no warranty, representation or guarantee regarding the suitability of its products for any particular purpose, nor does ON Semiconductor assume any liability arising out of the application or use of any product or circuit, and specifically disclaims any and all liability, including without limitation special, consequential or incidental damages. Buyer is responsible for its products and applications using ON Semiconductor products, including compliance with all laws, regulations and safety requirements or standards, regardless of any support or applications information provided by ON Semiconductor. "Typical" parameters which may be provided in ON Semiconductor data sheets and/or specifications can and do vary in different applications and actual performance may vary over time. All operating parameters, including "Typicals" must be validated for each customer application by customer's technical experts. ON Semiconductor does not convey any license under its patent rights nor the rights of others. ON Semiconductor products are not designed, intended, or authorized for use as a critical component in life support systems or any FDA Class 3 medical devices or medical devices with a same or similar classification in a foreign jurisdiction or any devices intended for implantation in the human body. Should Buyer purchase or use ON Semiconductor products for any such unintended or unauthorized application, Buyer shall indemnify and hold ON Semiconductor and its officers, employees, subsidiaries, affiliates, and distributors harmless against all claims, costs, damages, and expenses, and reasonable attorney fees arising out of, directly or indirectly, any claim of personal injury or death associated with such unintended or unauthorized use, even if such claim alleges that ON Semiconductor was negligent regarding the design or manufacture of the part. ON Semiconductor is an Equal Opportunity/Affirmative Action Employer. This literature is subject to all applicable copyright laws and is not for resale in any manner.

## PUBLICATION ORDERING INFORMATION

### LITERATURE FULFILLMENT:

Literature Distribution Center for ON Semiconductor  
19521 E. 32nd Pkwy, Aurora, Colorado 80011 USA  
Phone: 303-675-2175 or 800-344-3860 Toll Free USA/Canada  
Fax: 303-675-2176 or 800-344-3867 Toll Free USA/Canada  
Email: [orderlit@onsemi.com](mailto:orderlit@onsemi.com)

**N. American Technical Support:** 800-282-9855 Toll Free  
USA/Canada.  
**Europe, Middle East and Africa Technical Support:**  
Phone: 421 33 790 2910  
**Japan Customer Focus Center**  
Phone: 81-3-5817-1050

**ON Semiconductor Website:** [www.onsemi.com](http://www.onsemi.com)

**Order Literature:** <http://www.onsemi.com/orderlit>

For additional information, please contact your local  
Sales Representative



ON Semiconductor and  are trademarks of Semiconductor Components Industries, LLC dba ON Semiconductor or its subsidiaries in the United States and/or other countries. ON Semiconductor owns the rights to a number of patents, trademarks, copyrights, trade secrets, and other intellectual property. A listing of ON Semiconductor's product/patent coverage may be accessed at [www.onsemi.com/site/pdf/Patent-Marking.pdf](http://www.onsemi.com/site/pdf/Patent-Marking.pdf). ON Semiconductor reserves the right to make changes without further notice to any products herein. ON Semiconductor makes no warranty, representation or guarantee regarding the suitability of its products for any particular purpose, nor does ON Semiconductor assume any liability arising out of the application or use of any product or circuit, and specifically disclaims any and all liability, including without limitation special, consequential or incidental damages. Buyer is responsible for its products and applications using ON Semiconductor products, including compliance with all laws, regulations and safety requirements or standards, regardless of any support or applications information provided by ON Semiconductor. "Typical" parameters which may be provided in ON Semiconductor data sheets and/or specifications can and do vary in different applications and actual performance may vary over time. All operating parameters, including "Typicals" must be validated for each customer application by customer's technical experts. ON Semiconductor does not convey any license under its patent rights nor the rights of others. ON Semiconductor products are not designed, intended, or authorized for use as a critical component in life support systems or any FDA Class 3 medical devices or medical devices with a same or similar classification in a foreign jurisdiction or any devices intended for implantation in the human body. Should Buyer purchase or use ON Semiconductor products for any such unintended or unauthorized application, Buyer shall indemnify and hold ON Semiconductor and its officers, employees, subsidiaries, affiliates, and distributors harmless against all claims, costs, damages, and expenses, and reasonable attorney fees arising out of, directly or indirectly, any claim of personal injury or death associated with such unintended or unauthorized use, even if such claim alleges that ON Semiconductor was negligent regarding the design or manufacture of the part. ON Semiconductor is an Equal Opportunity/Affirmative Action Employer. This literature is subject to all applicable copyright laws and is not for resale in any manner.

## PUBLICATION ORDERING INFORMATION

### LITERATURE FULFILLMENT:

Literature Distribution Center for ON Semiconductor  
19521 E. 32nd Pkwy, Aurora, Colorado 80011 USA  
**Phone:** 303-675-2175 or 800-344-3860 Toll Free USA/Canada  
**Fax:** 303-675-2176 or 800-344-3867 Toll Free USA/Canada  
**Email:** [orderlit@onsemi.com](mailto:orderlit@onsemi.com)

**N. American Technical Support:** 800-282-9855 Toll Free  
USA/Canada  
**Europe, Middle East and Africa Technical Support:**  
Phone: 421 33 790 2910  
**Japan Customer Focus Center**  
Phone: 81-3-5817-1050

**ON Semiconductor Website:** [www.onsemi.com](http://www.onsemi.com)  
**Order Literature:** <http://www.onsemi.com/orderlit>  
For additional information, please contact your local  
Sales Representative