

BLM9D2022-08AM

LDMOS 2-stage integrated Doherty MMIC

Rev. 1 — 10 September 2020

AMPLEON

Product data sheet

1. Product profile

1.1 General description

The BLM9D2022-08AM is a 2-stage 8 W fully integrated Doherty MMIC solution using Ampleon's state of the art GEN9 LDMOS technology. The carrier and peaking device, input splitter and output combiner are integrated in a single package. This multiband device is perfectly suited as a device in the frequency range from 2110 MHz to 2170 MHz. Available in LGA outline.

Table 1. Performance

Typical RF performance at $T_{case} = 25\text{ }^{\circ}\text{C}$; $I_{Dq} = 23\text{ mA}$ (driver and final stages) in a demo circuit; $V_{GSq(peaking)} = V_{GSq(carrier)} - 0.55\text{ V}$.

Test signal	f (MHz)	V _{DS} (V)	P _{L(AV)} (W)	G _p (dB)	η _D (%)	ACPR _{5M} (dBc)
single carrier W-CDMA [1]	2140	28	1.12	27.4	41	-30

[1] Test signal: 3GPP test model 1; 64 DPCH; PAR = 7.2 dB at 0.01 % probability on CCDF.

1.2 Features and benefits

- Integrated input splitter
- Integrated output combiner
- Very high efficiency
- Designed for broadband operation (frequency 2110 MHz to 2170 MHz)
- Independent control of carrier and peaking bias
- Integrated ESD protection
- Excellent thermal stability
- High power gain, input and output matched to impedance 50 Ω
- For RoHS compliance see the product details on the Ampleon website

1.3 Applications

- RF power MMIC for multi-carrier and multi-standard GSM, W-CDMA, LTE and NR small cell base stations in the 2110 MHz to 2170 MHz frequency range

2. Pinning information

2.1 Pinning

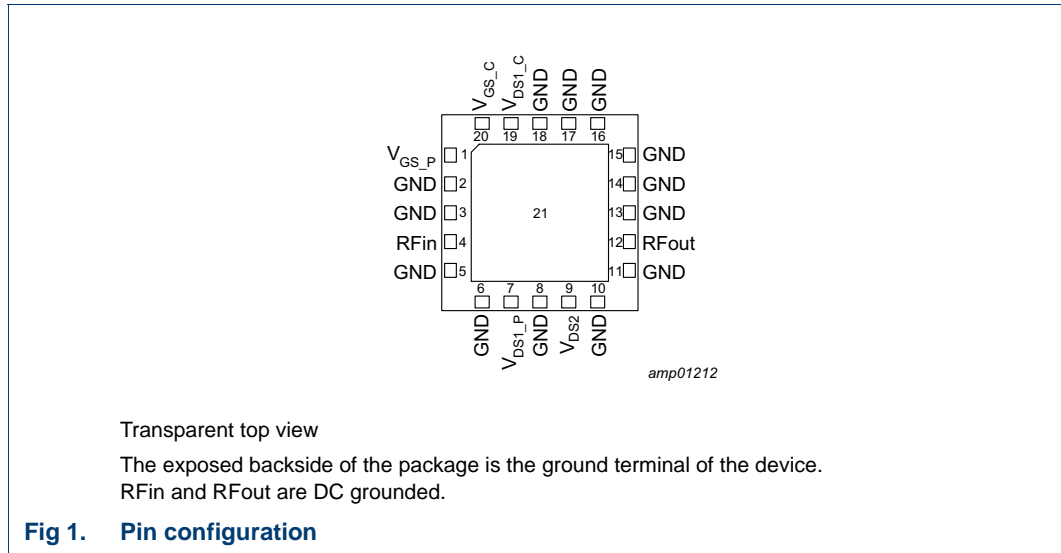

2.2 Pin description

Table 2. Pin description

Symbol	Pin	Description
V _{GS_P}	1	gate-source voltage of peaking
GND	2	ground
GND	3	ground
RFin	4	RF input
GND	5	ground
GND	6	ground
V _{DS1_P}	7	drain-source voltage of peaking driver
GND	8	ground
V _{DS2}	9	drain-source voltage of final stages
GND	10	ground
GND	11	ground
RFout	12	RF output
GND	13	ground
GND	14	ground
GND	15	ground
GND	16	ground
GND	17	ground
GND	18	ground

Table 2. Pin description ...continued

Symbol	Pin	Description
V_{DS1_C}	19	drain-source voltage of carrier driver
V_{GS_C}	20	gate-source voltage of carrier driver
GND	21	RF ground

3. Ordering information

Table 3. Ordering information

Type number	Package		
	Name	Description	Version
BLM9D2022-08AM	-	plastic thermal enhanced package; no leads; 20 terminals; body 7.0 x 7.0 x 0.98 mm	LGA-7x7-20-1

4. Block diagram

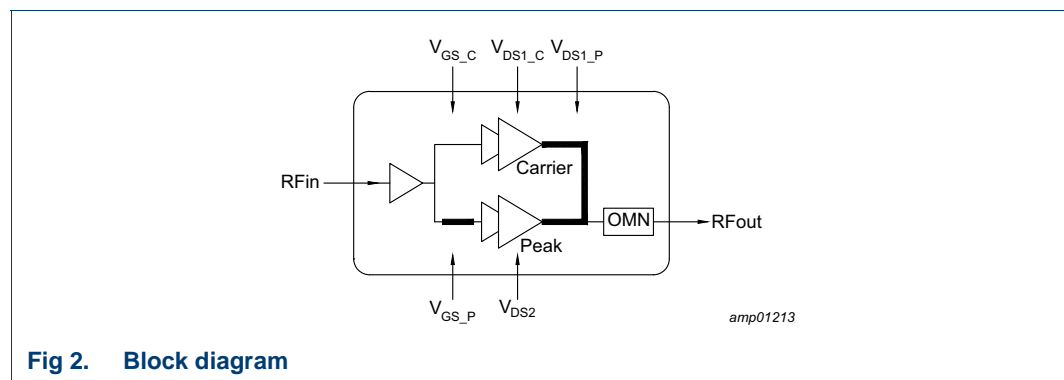

5. Limiting values

Table 4. Limiting values

In accordance with the Absolute Maximum Rating System (IEC 60134).

Symbol	Parameter	Conditions	Min	Max	Unit
V_{DS}	drain-source voltage		-	65	V
V_{GS}	gate-source voltage		-6	+11	V
T_{stg}	storage temperature		-55	+125	°C
T_j	junction temperature		[1]	175	°C
T_{case}	case temperature		[1]	125	°C

[1] Continuous use at maximum temperature will affect the reliability. For details refer to the online MTF calculator.

6. Thermal characteristics

Table 5. Thermal characteristics

Measured for total device.

Symbol	Parameter	Conditions	Value	Unit
R _{th(j-c)}	thermal resistance from junction to case	T _{case} = 80 °C; P _{L(AV)} = 1.12 W [1]	9.2	K/W
		T _{case} = 80 °C; P _{L(AV)} = 1.78 W [1]	8.3	K/W

[1] When operated with a 1-carrier W-CDMA with PAR = 7.2 dB.

7. Characteristics

Table 6. DC characteristics

T_{case} = 25 °C; unless otherwise specified.

Symbol	Parameter	Conditions	Min	Typ	Max	Unit
Carrier						
V _{GSq}	gate-source quiescent voltage	V _{DS} = 28 V; I _D = 23 mA	1.65	2	2.75	V
I _{GSS}	gate leakage current	V _{GS} = +11 V/-5 V; V _{DS} = 0 V	-	-	140	nA
Peaking						
I _{GSS}	gate leakage current	V _{GS} = +11 V/-5 V; V _{DS} = 0 V	-	-	140	nA
Final stages						
I _{DSS}	drain leakage current	V _{GS} = 0 V; V _{DS} = 60 V	-	-	1.4	μA
Driver stages						
I _{DSS}	drain leakage current	V _{GS} = 0 V; V _{DS} = 60 V	-	-	1.4	μA

Table 7. RF Characteristics

Typical RF performance at T_{case} = 25 °C; V_{DS} = 28 V; I_{Dq} = 23 mA (carrier);

V_{GSq(peaking)} = V_{GSq(carrier)} - 0.55 V; P_L = 1.12 W; f = 2.17 GHz. Unless otherwise specified, measured in an Ampleon production circuit.

Symbol	Parameter	Conditions	Min	Typ	Max	Unit
Test signal: CW pulsed						
G _p	power gain		25	26.6	29	dB
η _D	drain efficiency	P _L = 1.12 W	36	40.7	-	%
RL _{in}	input return loss		-	-16	-13	dB
P _{L(3dB)}	output power at 3 dB gain compression		38.5	39.2	-	dBm

8. Application information

Table 8. Typical performance

Test signal: 1-carrier W-CDMA; $T_{case} = 25\text{ °C}$; $V_{DS} = 28\text{ V}$; $I_{DQ} = 23\text{ mA}$ (driver and final stages); test model 1; 64 DPCH; PAR = 7.2 dB at 0.01 % probability CCDF; unless otherwise specified, measured in an Ampleon 2110 MHz to 2170 MHz frequency band demo circuit.

Symbol	Parameter	Conditions	Min	Typ	Max	Unit
$P_{L(3dB)}$	output power at 3 dB gain compression	$f = 2110\text{ MHz}$ [1]	-	39.5	-	dBm
η_D	drain efficiency	9 dB OBO ($P_{L(AV)} = 30.5\text{ dBm}$); $f = 2110\text{ MHz}$	-	41	-	%
G_p	power gain	$P_{L(AV)} = 30.5\text{ dBm}$; $f = 2110\text{ MHz}$	-	27.4	-	dB
G_{flat}	gain flatness	$P_{L(AV)} = 30.5\text{ dBm}$; $f = 2110\text{ MHz}$ to 2170 MHz	-	0.8	-	dB
$ACPR_{5M}$	adjacent channel power ratio (5 MHz)	$P_{L(AV)} = 30.5\text{ dBm}$; $f = 2110\text{ MHz}$	-	-30	-	dBc
$\Delta G/\Delta T$	gain variation with temperature	$f = 2110\text{ MHz}$	-	0.04	-	dB/°C
K	Rollett stability factor	$T_{case} = -40\text{ °C}$; $f = 0.15\text{ GHz}$ to 5 GHz [2]	-	>1	-	

[1] Pulsed CW power sweep measurement ($\delta = 10\%$, $t_p = 100\text{ }\mu\text{s}$).

[2] S-parameters measured in a demo circuit.

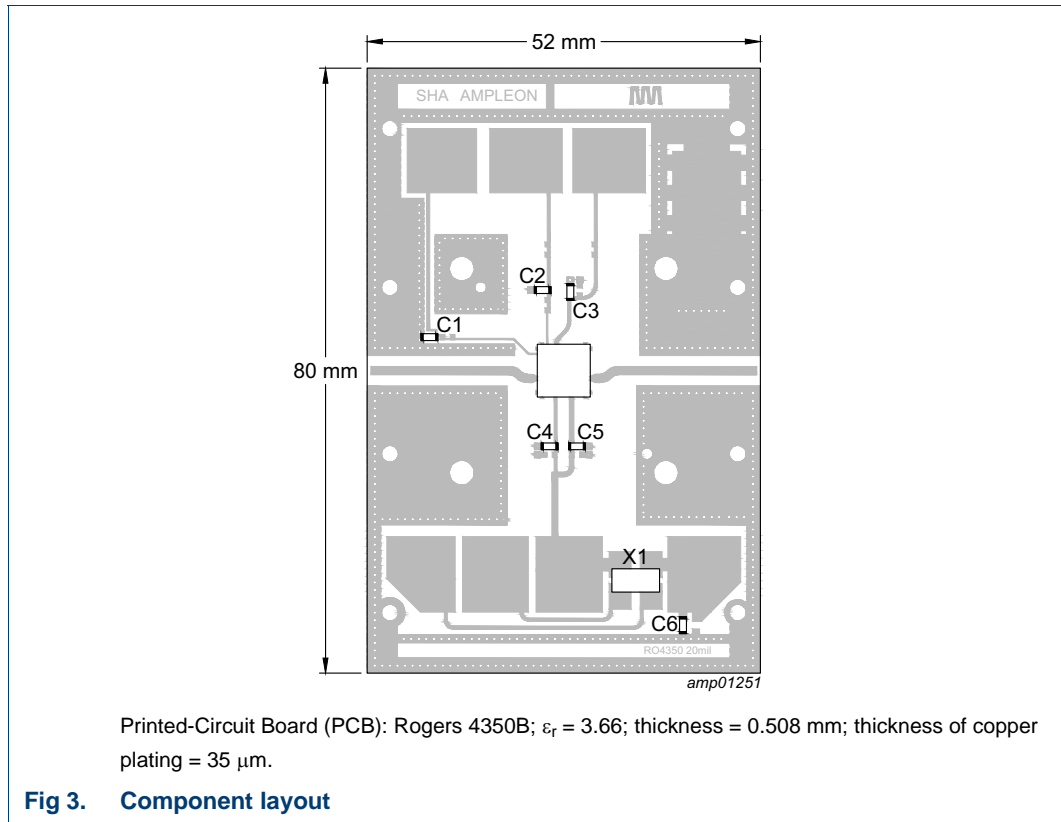

Table 9. Demo test circuit list of components

See [Figure 3](#) for component layout.

Component	Description	Value	Remarks
C1, C2, C3, C4, C5	multilayer ceramic chip capacitor	1 μF	[1]
C6	multilayer ceramic chip capacitor	1 μF	[2]
X1	current sense resistor	100 m Ω , 1 W	Y44870R10000B0R

[1] American Technical Ceramics type 600F or capacitor of same quality.

[2] Murata or capacitor of same quality.

8.1 Ruggedness in a Doherty operation

The BLM9D2022-08AM is capable of withstanding a load mismatch corresponding to $V_{\text{SWR}} = 10 : 1$ through all phases under the following conditions: $V_{\text{DS}} = 28 \text{ V}$; $I_{\text{Dq}} = 23 \text{ mA}$ (carrier); $V_{\text{GSq(peak)}} = V_{\text{GSq(carrier)}} - 0.55 \text{ V}$; P_i corresponding to $P_{\text{L}(3\text{dB})}$ under $Z_{\text{S}} = 50 \Omega$ load; $f = 2110 \text{ MHz}$ (CW); $T_{\text{case}} = 25 \text{ }^\circ\text{C}$.

8.2 Graphs

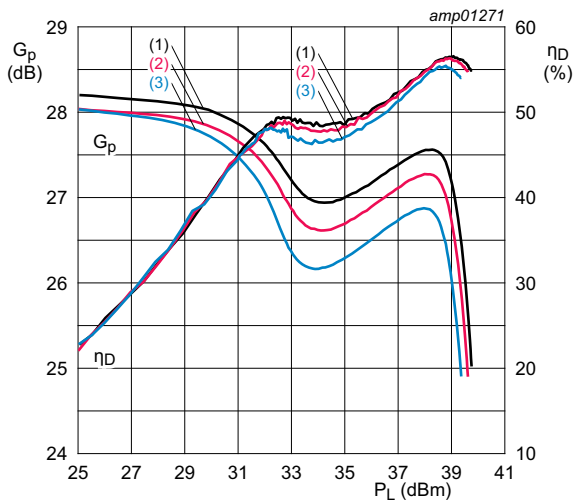

$V_{DS} = 28\text{ V}; I_{Dq} = 23\text{ mA}; V_{GS(amp)peak} = 1.54\text{ V};$
 $t_p = 100\text{ }\mu\text{s}; \delta = 10\text{ } \%$
 (1) $f = 2100\text{ MHz}$
 (2) $f = 2140\text{ MHz}$
 (3) $f = 2170\text{ MHz}$

Fig 4. Power gain and drain efficiency as function of output power; typical values

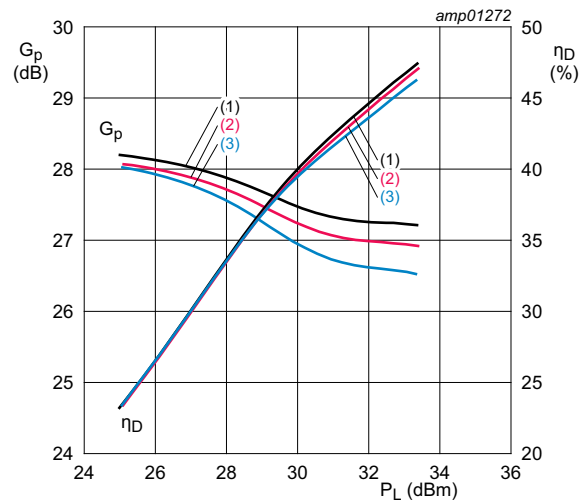

$V_{DS} = 28\text{ V}; I_{Dq} = 23\text{ mA}; V_{GS(amp)peak} = 1.54\text{ V}.$
 Test signal: 1-carrier W-CDMA; 3GPP test model 1; 64 DPCH; PAR = 7.2 dB at 0.01 % probability on CCDF.
 (1) $f = 2100\text{ MHz}$
 (2) $f = 2140\text{ MHz}$
 (3) $f = 2170\text{ MHz}$

Fig 5. Power gain and drain efficiency as function of output power; typical values

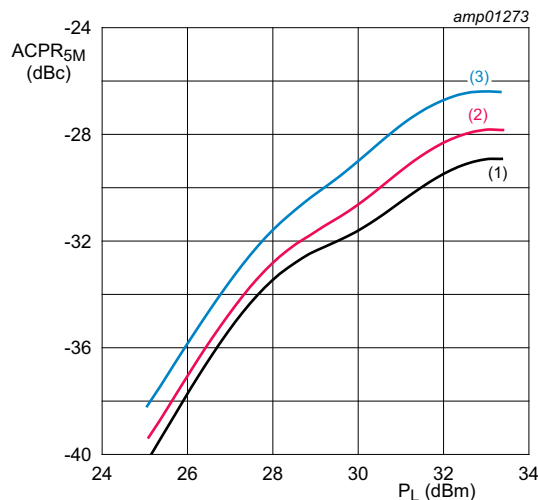

$V_{DS} = 28\text{ V}; I_{Dq} = 23\text{ mA}; V_{GS(amp)peak} = 1.54\text{ V}.$
 Test signal: 1-carrier W-CDMA; 3GPP test model 1; 64 DPCH; PAR = 7.2 dB at 0.01 % probability on CCDF.
 (1) $f = 2100\text{ MHz}$
 (2) $f = 2140\text{ MHz}$
 (3) $f = 2170\text{ MHz}$

Fig 6. Adjacent channel power ratio as a function of output power; typical values

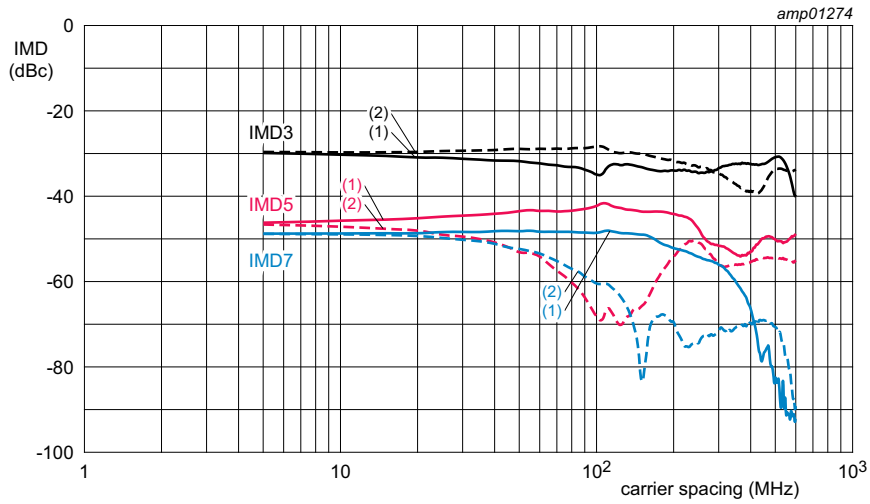

$V_{DS} = 28\text{ V}$; $I_{Dq} = 23\text{ mA}$; $V_{GS(amp)peak} = 1.54\text{ V}$; $f = 2140\text{ MHz}$.

Test signal: 2-carrier CW.

- (1) IMD low
- (2) IMD high

Fig 7. VBW capability

9. Package outline

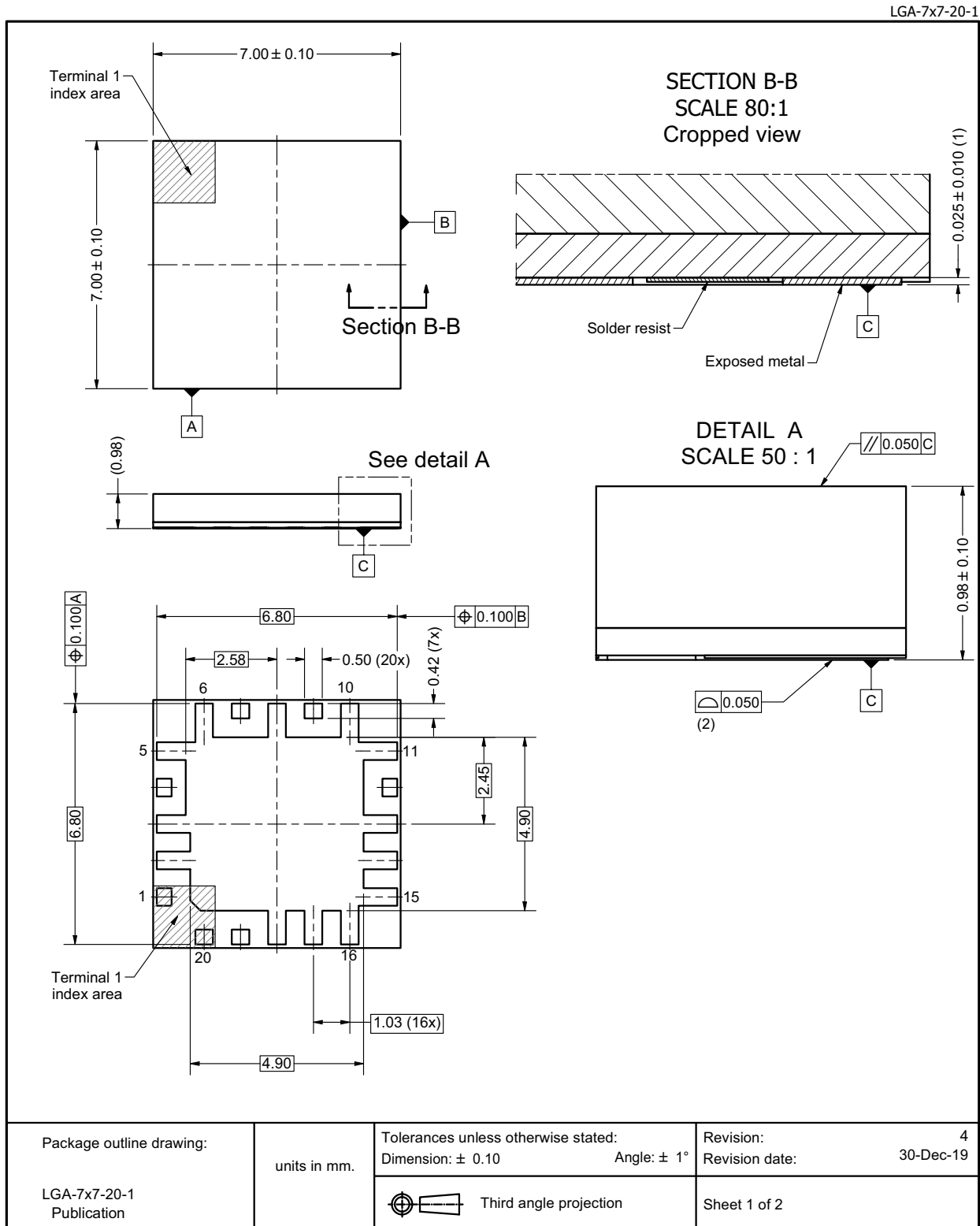

Fig 8. Package outline LGA-7x7-20-1 (sheet 1 of 2)

10. Handling information

CAUTION



This device is sensitive to ElectroStatic Discharge (ESD). Observe precautions for handling electrostatic sensitive devices.
Such precautions are described in the *ANSI/ESD S20.20*, *IEC/ST 61340-5*, *JESD625-A* or equivalent standards.

Table 10. ESD sensitivity

ESD model	Class
Charged Device Model (CDM); According to ANSI/ESDA/JEDEC standard JS-002	C2A [1]
Human Body Model (HBM); According to ANSI/ESDA/JEDEC standard JS-001	1C [2]

- [1] CDM classification C2A is granted to any part that passes after exposure to an ESD pulse of 500 V.
- [2] HBM classification 1C is granted to any part that passes after exposure to an ESD pulse of 1000 V.

11. Abbreviations

Table 11. Abbreviations

Acronym	Description
3GPP	3rd Generation Partnership Project
CCDF	Complementary Cumulative Distribution Function
CW	Continuous Wave
DPCH	Dedicated Physical CHannel
ESD	ElectroStatic Discharge
GEN9	Ninth Generation
GSM	Global System for Mobile Communications
LDMOS	Laterally Diffused Metal Oxide Semiconductor
LTE	Long Term Evolution
MMIC	Monolithic Microwave Integrated Circuit
MTF	Median Time to Failure
NR	New Radio
OBO	Output Back Off
PAR	Peak-to-Average Ratio
RoHS	Restriction of Hazardous Substances
VBW	Video Bandwidth
VSWR	Voltage Standing Wave Ratio
W-CDMA	Wideband Code Division Multiple Access

12. Revision history

Table 12. Revision history

Document ID	Release date	Data sheet status	Change notice	Supersedes
BLM9D2022-08AM v.1	20200910	Product data sheet	-	-

13. Legal information

13.1 Data sheet status

Document status ^{[1][2]}	Product status ^[3]	Definition
Objective [short] data sheet	Development	This document contains data from the objective specification for product development.
Preliminary [short] data sheet	Qualification	This document contains data from the preliminary specification.
Product [short] data sheet	Production	This document contains the product specification.

[1] Please consult the most recently issued document before initiating or completing a design.

[2] The term 'short data sheet' is explained in section "Definitions".

[3] The product status of device(s) described in this document may have changed since this document was published and may differ in case of multiple devices. The latest product status information is available on the Internet at URL <http://www.ampleon.com>.

13.2 Definitions

Draft — The document is a draft version only. The content is still under internal review and subject to formal approval, which may result in modifications or additions. Ampleon does not give any representations or warranties as to the accuracy or completeness of information included herein and shall have no liability for the consequences of use of such information.

Short data sheet — A short data sheet is an extract from a full data sheet with the same product type number(s) and title. A short data sheet is intended for quick reference only and should not be relied upon to contain detailed and full information. For detailed and full information see the relevant full data sheet, which is available on request via the local Ampleon sales office. In case of any inconsistency or conflict with the short data sheet, the full data sheet shall prevail.

Product specification — The information and data provided in a Product data sheet shall define the specification of the product as agreed between Ampleon and its customer, unless Ampleon and customer have explicitly agreed otherwise in writing. In no event however, shall an agreement be valid in which the Ampleon product is deemed to offer functions and qualities beyond those described in the Product data sheet.

Right to make changes — Ampleon reserves the right to make changes to information published in this document, including without limitation specifications and product descriptions, at any time and without notice. This document supersedes and replaces all information supplied prior to the publication hereof.

Suitability for use — Ampleon products are not designed, authorized or warranted to be suitable for use in life support, life-critical or safety-critical systems or equipment, nor in applications where failure or malfunction of an Ampleon product can reasonably be expected to result in personal injury, death or severe property or environmental damage. Ampleon and its suppliers accept no liability for inclusion and/or use of Ampleon products in such equipment or applications and therefore such inclusion and/or use is at the customer's own risk.

Applications — Applications that are described herein for any of these products are for illustrative purposes only. Ampleon makes no representation or warranty that such applications will be suitable for the specified use without further testing or modification.

Customers are responsible for the design and operation of their applications and products using Ampleon products, and Ampleon accepts no liability for any assistance with applications or customer product design. It is customer's sole responsibility to determine whether the Ampleon product is suitable and fit for the customer's applications and products planned, as well as for the planned application and use of customer's third party customer(s). Customers should provide appropriate design and operating safeguards to minimize the risks associated with their applications and products.

Ampleon does not accept any liability related to any default, damage, costs or problem which is based on any weakness or default in the customer's applications or products, or the application or use by customer's third party customer(s). Customer is responsible for doing all necessary testing for the customer's applications and products using Ampleon products in order to avoid a default of the applications and the products or of the application or use by customer's third party customer(s). Ampleon does not accept any liability in this respect.

Limiting values — Stress above one or more limiting values (as defined in the Absolute Maximum Ratings System of IEC 60134) will cause permanent damage to the device. Limiting values are stress ratings only and (proper) operation of the device at these or any other conditions above those given in the Recommended operating conditions section (if present) or the Characteristics sections of this document is not warranted. Constant or repeated exposure to limiting values will permanently and irreversibly affect the quality and reliability of the device.

Terms and conditions of commercial sale — Ampleon products are sold subject to the general terms and conditions of commercial sale, as published at <http://www.ampleon.com/terms>, unless otherwise agreed in a valid written individual agreement. In case an individual agreement is concluded only the terms and conditions of the respective agreement shall apply. Ampleon hereby expressly objects to applying the customer's general terms and conditions with regard to the purchase of Ampleon products by customer.

13.3 Disclaimers

Maturity — The information in this document can only be regarded as final once the relevant product(s) has passed the Release Gate in Ampleon's release process. Prior to such release this document should be regarded as a draft version.

Limited warranty and liability — Information in this document is believed to be accurate and reliable. However, Ampleon does not give any representations or warranties, expressed or implied, as to the accuracy or completeness of such information and shall have no liability for the consequences of use of such information. Ampleon takes no responsibility for the content in this document if provided by an information source outside of Ampleon.

In no event shall Ampleon be liable for any indirect, incidental, punitive, special or consequential damages (including - without limitation - lost profits, lost savings, business interruption, costs related to the removal or replacement of any products or rework charges) whether or not such damages are based on tort (including negligence), warranty, breach of contract or any other legal theory.

Notwithstanding any damages that customer might incur for any reason whatsoever, Ampleon's aggregate and cumulative liability towards customer for the products described herein shall be limited in accordance with the *Terms and conditions of commercial sale* of Ampleon.

No offer to sell or license — Nothing in this document may be interpreted or construed as an offer to sell products that is open for acceptance or the grant, conveyance or implication of any license under any copyrights, patents or other industrial or intellectual property rights.

Export control — This document as well as the item(s) described herein may be subject to export control regulations. Export might require a prior authorization from competent authorities.

Non-automotive qualified products — Unless this data sheet expressly states that this specific Ampleon product is automotive qualified, the product is not suitable for automotive use. It is neither qualified nor tested in accordance with automotive testing or application requirements. Ampleon accepts no liability for inclusion and/or use of non-automotive qualified products in automotive equipment or applications.

In the event that customer uses the product for design-in and use in automotive applications to automotive specifications and standards, customer (a) shall use the product without Ampleon's warranty of the product for such

automotive applications, use and specifications, and (b) whenever customer uses the product for automotive applications beyond Ampleon's specifications such use shall be solely at customer's own risk, and (c) customer fully indemnifies Ampleon for any liability, damages or failed product claims resulting from customer design and use of the product for automotive applications beyond Ampleon's standard warranty and Ampleon's product specifications.

Translations — A non-English (translated) version of a document is for reference only. The English version shall prevail in case of any discrepancy between the translated and English versions.

13.4 Trademarks

Notice: All referenced brands, product names, service names and trademarks are the property of their respective owners.

14. Contact information

For more information, please visit: <http://www.ampleon.com>

For sales office addresses, please visit: <http://www.ampleon.com/sales>

15. Contents

1 **Product profile** 1

1.1 General description 1

1.2 Features and benefits 1

1.3 Applications 1

2 **Pinning information** 2

2.1 Pinning 2

2.2 Pin description 2

3 **Ordering information** 3

4 **Block diagram** 3

5 **Limiting values** 3

6 **Thermal characteristics** 4

7 **Characteristics** 4

8 **Application information** 5

8.1 Ruggedness in a Doherty operation 6

8.2 Graphs 7

9 **Package outline** 9

10 **Handling information** 11

11 **Abbreviations** 11

12 **Revision history** 11

13 **Legal information** 12

13.1 Data sheet status 12

13.2 Definitions 12

13.3 Disclaimers 12

13.4 Trademarks 13

14 **Contact information** 13

15 **Contents** 14

Please be aware that important notices concerning this document and the product(s) described herein, have been included in section 'Legal information'.

© Ampleon Netherlands B.V. 2020. All rights reserved.

For more information, please visit: <http://www.ampleon.com>
 For sales office addresses, please visit: <http://www.ampleon.com/sales>

Date of release: 10 September 2020
 Document identifier: BLM9D2022-08AM