

Commercial Products

High Reliability Products

High Temperature Products

Application Specific

Capacitor Assemblies

Radial Leaded capacitors

Detonation & Pluse Energy Capacitors

Specialty Products

Custom Designs

# *MLC Capacitors*

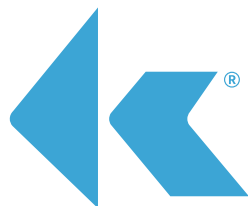

# knowles

# Contents



<b>Intro</b>	Products by Market	Page 1
	The Company	Page 2
	Technical Summary	Page 3
	Dielectric Characteristics	Page 4 - 7
<b>Technical Data</b>	Capacitor Manufacturing Process	Page 8
	MIL PRF-123 Periodic Testing	Page 9
	Board Design Considerations	Page 10
	FlexiCap™ Polymer Termination	Page 11
	Chip Dimensions	Page 12
	Capacitor Marking System	Page 13
	Chip Taping Details	Page 14
	Chip Ordering Information	Page 15
	Commercial Chip - C0G 16Vdc to 10kVdc	Page 16 - 17
	Commercial Chip - R3L 16Vdc to 5kVdc	Page 18 - 19
	Commercial Chip - X7R 16Vdc to 10kVdc	Page 20 - 21
<b>Commercial Products</b>	Commercial Chip - BX	Page 22
	Commercial Chip - Z5U & Y5V	Page 22
	Commercial Chip - BX & X7R RF series	Page 23
	Commercial Radial Lead - 50V to 5kV	Page 24
	Commercial Radial Lead - 500V to 10kV	Page 25
	Leaded Products Ordering Information	Page 26
	High Reliability Testing	Page 27
	High Reliability Chip - C0G 16Vdc to 10kVdc	Page 28 - 29
	High Reliability Chip - X7R 16Vdc to 10kVdc	Page 30 - 31
	High Reliability Radial Lead - 500Vdc to 10kVdc	Page 32
<b>High Reliability Products</b>	DSCC Approved - Radial Lead	Page 33
	DSCC Approved - Capacitor Assemblies	Page 34
	Product Reliability Groups	Page 35
	Lot Testing	Page 36
	Lot Test Details	Page 37
	High Temperature Applications Introduction	Page 38
	High Temperature Chip - 150°C, 160°C & 200°C	Page 39
<b>High Temperature Products</b>	High Temperature Radial Lead - Epoxy Coated	Page 40
	High Temperature Radial Lead - Encapsulated	Page 41
	Certified Safety Chip - X <sup>2</sup> , Y <sup>3</sup> & X <sup>1</sup> , Y <sup>2</sup>	Page 42 - 43
<b>Application Specific</b>	High Capacitance Chip - X7R & X5R (BME)	Page 44 - 45
	Non Magnetic Chip - C0G & X7R	Page 46
	Thin Profile Chip	Page 47
<b>Capacitor Assemblies</b>	Capacitor Assemblies - ST & SM	Page 48 - 49
	Capacitor Assemblies - C0G Commercial & High Reliability	Page 50 - 51
	Capacitor Assemblies - X7R Commercial & High Reliability	Page 52 - 53
	Capacitor Assemblies - 'Cap-Rack' Arrays	Page 54
<b>Specialty Products</b>	Specialty Capacitors - Application Specific	Page 55
	Specialty Capacitors - Detonation & Pulse Energy Capacitors	Page 56 - 57
	Specialty Capacitors - Custom Designs	Page 58 - 59

**Note:** Novacap reserves the right to make changes in product designs and/or pricing. Sales are subject to Novacap terms and conditions. Novacap warrants that its product(s) will be free from defects in workmanship or materials at the time of delivery, subject to the provisions of this Limited Warranty. For complete terms and conditions of sale please refer to the Sales Office or on the web at <http://novacap.com/terms.php>.

# Products by Market

	Aerospace & Avionics	Automotive	Medical	Military & Defense	Oil Exploration	Power Conversion	Tele/Datacom
1							
2							
3							
4							
5							
6							
7							
8							
9							
10							
11							
12							
13							
14							
15							
16							
17							
18							
19							
20							
21							
22							
23							
24							
25							
26							
27							
28							
29							
30							
31							
32							
33							
34							
35							
36							
37							
38							
39							
40							
41							
42							
43							
44							
45							
46							
47							
48							
49							
50							

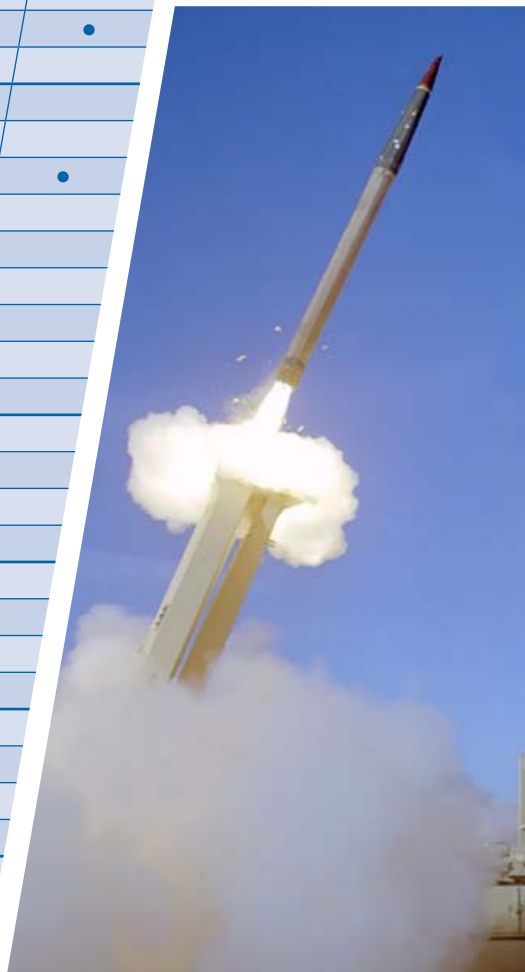

# The Company

**Novacap** manufactures surface mount and leaded Multilayer Ceramic Capacitors (MLC) as well as specialty assemblies for your circuit applications. We are part of Knowles Capacitors, an operating company within Knowles Corporation.



Valencia, California

Our standard sizes range from 0402 to 7565, and we provide voltage ratings from 4V to 10kV.

We are flexible, quick, reliable and innovative! Call us with your particular requirements.



Guaymas, Mexico.

Some of our offerings include:

- Full range of surface mount chip capacitors
- High Reliability capacitors for use in Medical Implantable Devices and Life Support Systems
- High Temperature capacitors for harsh environments such as Oil Exploration, Automotive and Avionics Engine Compartment circuitry
- Custom Capacitor Modules for ratings up to 20kV
- Capacitor Arrays for highly efficient use of board space
- Certified Safety (Y<sup>2</sup>, Y<sup>3</sup>) and Ring Detect Capacitors for Telecommunications
- High Voltage capacitors, with ratings up to 10kV, designed for Commercial and Military use in Power Supply and Voltage Multiplier circuits
- Pulsed Energy capacitors for Oil Exploration and Detonation
- Radial Leaded capacitors
- Thin Profile capacitors for RFID and smart cards.
- Stacked Capacitor Assemblies for input and output filters in Switch Mode Power Supplies, High Capacitance Discharge Circuitry and High Temperature Filtering and Decoupling



## Technical Information

Novacap provides application notes throughout this catalog as a guide to chip selection and attachment methods. Refer to the Novacap Technical Brochure found at [www.novacap.com](http://www.novacap.com) for more details. This technical information includes the nature of capacitance, dielectric properties, electrical properties, classes of dielectrics, ferroelectric behavior, test standards, and high reliability test plans. Please do not hesitate to contact the sales office for any product or technical assistance.

## Capacitor Size

Size availability is based primarily on capacitance values and voltage rating. Smaller units are generally less expensive. Because mass affects the thermal shock susceptibility of chip capacitors, size selection should consider the soldering method used to attach the chip to the board. Sizes 1812 and smaller can be wave, vapor phase, or reflow soldered. Larger units require reflow soldering.

## Chip Selection

Multilayer capacitors (MLC) are categorized by dielectric performance with temperature. The Temperature Coefficient of Capacitance describes the variance of capacitance value with temperature. The choice of components is therefore largely determined by the temperature stability required of the device and the size necessary for the desired capacitance value and voltage rating.

## Packaging

Units are available reeled, in waffle pack, or bulk packaged. Bar coded labels are standard for reeled and bulk packaging.

## Primary Dielectric Types

### COG/NP0:

Ultra stable Class I dielectric, with negligible dependence of capacitance on temperature, voltage, frequency, and time. Used in circuitry requiring very stable performance.

### X7R:

Stable Class II dielectric, with predictable change in properties across a temperature range of -55°C to +125°C. Used as blocking, decoupling, bypassing, and frequency discriminating elements. This dielectric is ferroelectric and provides higher capacitance than Class I materials.

### BX:

The military specification for ceramic chip capacitors (MIL-PRF-55681) defines a mid-K stable dielectric designated as BX. The BX specification has voltage temperature limits in addition to temperature limits of capacitance. The BX dielectric is limited to ±15% maximum change in capacitance between 25°C and -55°C or +125°C and also has a voltage restriction of +15% / -25% maximum change in capacitance between 25°C and -55°C or +125°C at rated voltage.

### Z5U/Y5V:

General purpose Class III dielectrics with higher dielectric constant and greater variation of properties over temperature and voltage. Very high capacitance per volume is attainable for general purpose applications where stability over a wide temperature range is not critical.

## Dielectric Termination Combinations

Dielectric	Code	Palladium Silver	Palladium Silver	Solderable Palladium Silver	Nickel Barrier 100% tin	Nickel Barrier 90/10% tin/lead	Nickel Barrier Gold flash	FlexiCap™/Nickel Barrier 100% tin	FlexiCap™/Nickel Barrier 90/10% tin/lead	Copper Barrier 100% tin	Copper Barrier 90/10% tin/lead	Solderable Silver
		RoHS	RoHS	RoHS	RoHS	RoHS	RoHS	RoHS	RoHS	RoHS	RoHS	RoHS
COG/NP0	N/RN	•	•	•	•	•	•	•	•			•
R3L	K	•	•	•	•	•	•	•	•			
X7R	B/RB	•	•	•	•	•	•	•	•			•
X7R BME	BB				•	•	•					
X5R BME	BW				•	•	•					
BX	X	•	•	•	•	•	•	•	•			•
Y5V	Y							•	•			
Z5U	Z							•	•			
COG/NP0 (Mag free)	M	•	•	•						•	•	
X7R (Mag free)	C	•	•	•						•	•	
X8R	S	•	•	•	•	•		•	•			•
COG/NP0 (160°C)	F	•	•	•	•	•		•	•			•
COG/NP0 (200°C)	D			•								•
Class II (160°C)	G	•	•	•	•	•		•	•			•
Class II (200°C)	E			•								•
Pulse Power	P	•	•	•								
R2D	R	•	•	•								

## Termination Material

We recommend the following termination types:

### Solder Attachment:

- N** Nickel Barrier, 100% matte tin plated - RoHS
  - C** FlexiCap™ with Nickel Barrier, 100% tin plated - RoHS
  - Y** Nickel Barrier, tin-lead plated
  - D** FlexiCap™ Nickel Barrier, tin-lead plated
  - B** Copper Barrier 100% matte tin plated - RoHS
  - E** Copper Barrier, tin-lead plated
  - K** Solderable Palladium Silver - RoHS (suitable for conductive epoxy attach)
  - S** Solderable Silver - RoHS
- Conductive Epoxy attachment:**
- P** Palladium Silver
  - PR** Palladium Silver - RoHS
  - NG** Nickel Barrier Gold Flash - RoHS (suitable for soldering attach)



# Dielectric Characteristics

## COG/NP0 (N) Ultra Stable and RoHS 2013 (RN) type

Operating temperature range:	-55°C to 125°C
Temperature coefficient:	0 ±30 ppm/°C
Dissipation factor:	0.1% max @ 25°C
Insulation resistance	@25°C: >100GΩ or >1000ΩF whichever is less @125°C: >10GΩ or >100ΩF whichever is less
Dielectric withstanding voltage	<200V: 250% 201-500V: 150% or 500V whichever is greater >500V: 120% or 750V whichever is greater
Ageing rate:	0% per decade
Test parameters:	1KHz, 1.0 ±0.2 VRMS, 25°C 1MHz for Capacitance ≤100pF

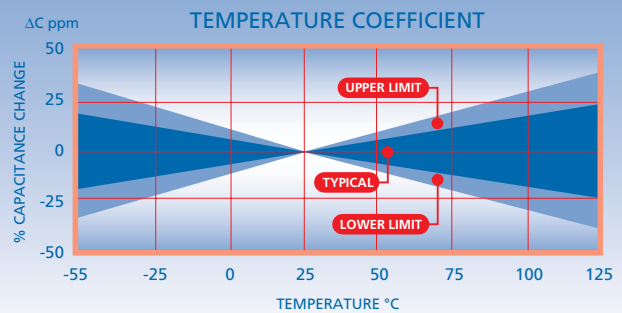

## COG/NP0 (M) Ultra Stable Non Magnetic

Operating temperature range:	-55°C to 125°C
Temperature coefficient:	0 ±30 ppm/°C
Dissipation factor:	0.1% max @ 25°C
Insulation resistance	@25°C: >1000ΩF or >10000ΩF whichever is less @125°C: >100ΩF or >1000ΩF whichever is less
Dielectric withstanding voltage	<200V: 250% 201-500V: 150% or 500V whichever is greater >500V: 120% or 750V whichever is greater
Ageing rate:	0% per decade
Test parameters:	1KHz, 1.0 ±0.2 VRMS, 25°C 1MHz for Capacitance ≤100pF

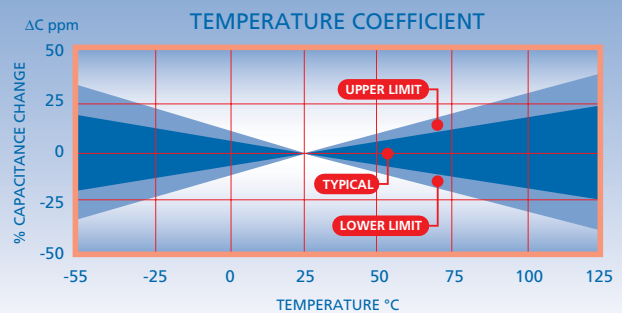

## COG/NP0 (F) Ultra Stable High Temperature (up to 160°C)

Operating temperature range:	-55°C to 160°C
Temperature coefficient:	0 ±30 ppm/°C
Dissipation factor:	0.1% max @ 25°C
Insulation resistance	@25°C: >100GΩ or >1000ΩF whichever is less @160°C: >1GΩ or >10ΩF whichever is less
Dielectric withstanding voltage	<200V: 250% 201-500V: 150% or 500V whichever is greater >500V: 120% or 750V whichever is greater
Ageing rate:	0% per decade
Test parameters:	1KHz, 1.0 ±0.2 VRMS, 25°C 1MHz for Capacitance ≤100pF

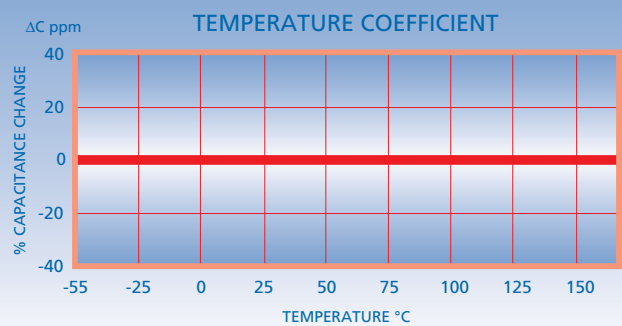

## COG/NP0 (D) Ultra Stable High Temperature (up to 200°C)

Operating temperature range:	-55°C to 200°C
Temp. coefficient ≤200°C:	0 ±30 ppm/°C
Dissipation factor @ 25°C:	0.1% Max.
Insulation resistance	@25°C: >100GΩ or >1000ΩF whichever is less @200°C: >1GΩ or >10ΩF whichever is less
Dielectric withstanding voltage	<200V: 250% 201-500V: 150% or 500V whichever is greater >500V: 120% or 750V whichever is greater
Ageing rate:	0% per decade
Test parameters:	1KHz, 1.0 ±0.2 VRMS, 25°C 1MHz for capacitance ≤100pF

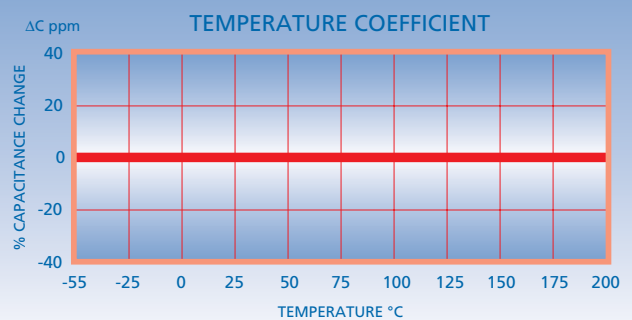

# Dielectric Characteristics

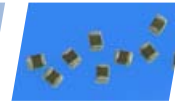

## R3L (K) Ultra Stable

Operating temperature range:	-55°C to 125°C
Temperature coefficient:	-2200 ±500 ppm/°C
Dissipation factor:	0.1% max @ 25°C
Insulation resistance	@25°C: >1000ΩF or >10000ΩF whichever is less @125°C: >100ΩF or >1000ΩF whichever is less
Dielectric withstanding voltage	≤200V: 250% 201-500V: 150% or 500V whichever is greater >500V: 120% or 750V whichever is greater
Ageing rate:	0% per decade
Test parameters:	1KHz, 1.0 ±0.2 VRMS, 25°C 1MHz for Capacitance ≤100pF

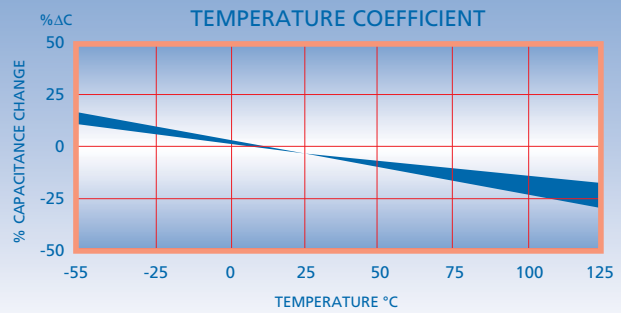

## R2D (R) Pulse Energy

Operating temperature range:	-55°C to 200°C
Temperature coefficient:	-2200 ±500 ppm/°C
Dissipation factor:	0.1% max @ 25°C
Insulation resistance	@25°C: >100GΩ or >1000ΩF whichever is less @200°C: >1GΩ or >10ΩF whichever is less
Dielectric withstanding voltage:	120%
Ageing rate:	0% per decade
Test parameters:	1KHz, 1.0 ±0.2 VRMS, 25°C

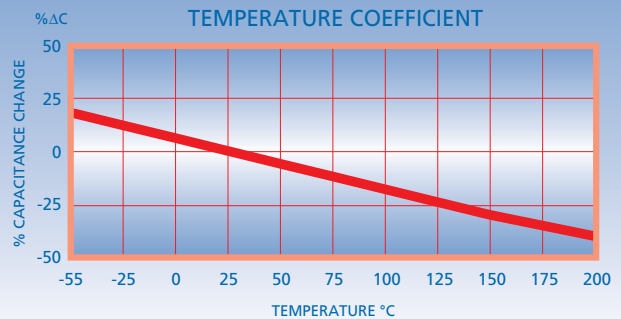

## Y5V (Y) General Purpose

Operating temperature range:	-30°C to 85°C
Temperature coefficient:	+22% -82% ΔC Max.
Dissipation factor	>25V rating: 5.0% max ≤25V rating: 7.0% max
Insulation resistance @25%:	>10GΩ or >100ΩF whichever is less
Dielectric withstanding voltage	≤200V: 250% 250V: 150%
Ageing rate:	4.0% per decade
Test parameters:	1KHz, 1.0 ±0.2 VRMS, 25°C

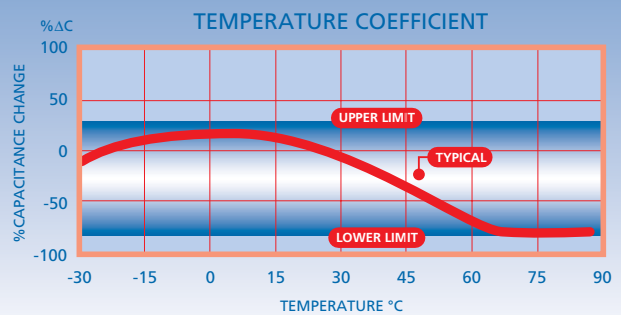

## Z5U (Z) General Purpose

Operating temperature range:	+10°C to 85°C
Temperature coefficient:	+22% -56% ΔC Max.
Dissipation factor:	4.0% max @ 25°C
Insulation resistance @25%	>10GΩ or >100ΩF whichever is less
Dielectric withstanding voltage	≤200V: 250% 250V: 150%
Ageing rate:	4.0% per decade
Test parameters:	1KHz, 0.5 ±0.2 VRMS, 25°C

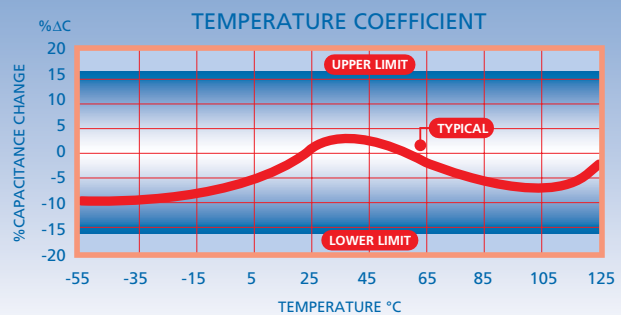

## X7R (B) Stable and RoHS 2013 (RB) type

Operating temperature range:	-55°C to 125°C
Temperature coefficient :	±15% ΔC Max.
Dissipation factor	>25V rating: 2.5% max ≤25V rating: 3.5% max
Insulation resistance:	@25°C: >100GΩ or >1000ΩF whichever is less @125°C: >10GΩ or >100ΩF whichever is less
Dielectric withstanding voltage	≤200V: 250% 201-500V: 150% or 500V whichever is greater >500V: 120% or 750V whichever is greater
Ageing rate:	<2.0% per decade
Test parameters:	1KHz, 1.0 ±0.2 VRMS, 25°C

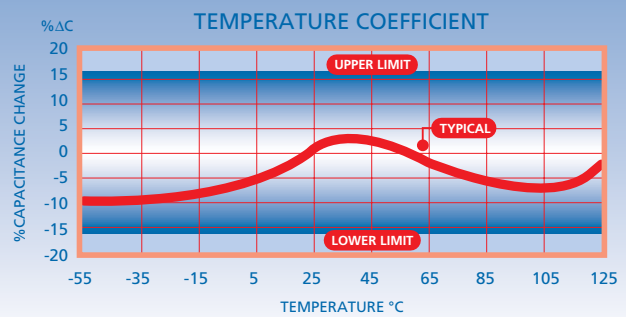

## X7R (C) Stable Non Magnetic

Operating temperature range:	-55°C to 125°C
Temperature coefficient:	±15% ΔC Max.
Dissipation factor	>25V rating: 2.5% max ≤25V rating: 3.5% max
Insulation resistance:	@25°C: >100GΩ or >1000ΩF whichever is less @125°C: >10GΩ or >100ΩF whichever is less
Dielectric withstanding voltage	≤200V: 250% 201-500V: 150% or 500V whichever is greater >500V: 120% or 750V whichever is greater
Ageing rate:	<2.0% per decade
Test parameters:	1KHz, 1.0 ±0.2 VRMS, 25°C

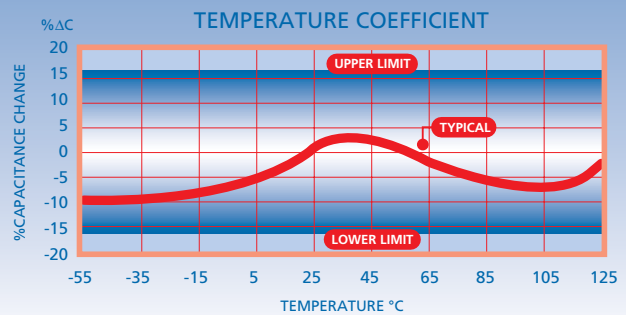

## BX (X) Stable

Operating temperature range:	-55°C to 125°C
Temperature coefficient:	±15% ΔC Max.
Temp-voltage coefficient:	+15% -25% ΔC Max.
Dissipation factor	>25V rating: 2.5% max ≤25V rating: 3.5% max
Insulation resistance:	@25°C: >100GΩ or >1000ΩF whichever is less @125°C: >10GΩ or >100ΩF whichever is less
Dielectric withstanding voltage	≤200V: 250% 201-500V: 150% or 500V whichever is greater >500V: 120% or 750V whichever is greater
Ageing rate:	<2.0% per decade
Test parameters:	1KHz, 1.0 ±0.2 VRMS, 25°C

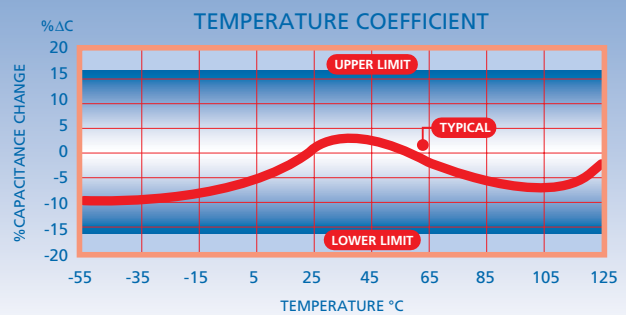

## X8R (S) Stable

Operating temperature range:	-55°C to 150°C
Temp. coefficient ≤150°C:	±15% ΔC Max.
Dissipation factor	>25V rating: 2.5% max ≤25V rating: 3.5% max
Insulation resistance	@25°C: >100GΩ or >1000ΩF whichever is less @150°C: >10GΩ or >100ΩF whichever is less
Dielectric withstanding voltage	≤200V: 250% 201-500V: 150% or 500V whichever is greater >500V: 120% or 750V whichever is greater
Ageing rate:	<2.0% per decade
Test parameters:	1KHz, 1.0 ±0.2 VRMS, 25°C

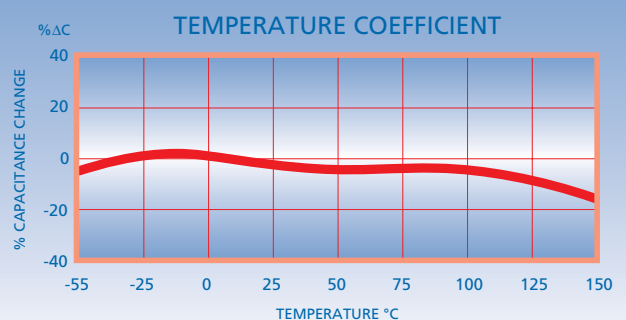



# Dielectric Characteristics



## Class II (G) Stable High Temperature (up to 160°C)

Operating temperature range:	-55°C to 160°C
Temperature coefficient up to 160°C:	+15 -40% ΔC Max.
Dissipation factor @ 25°C:	2.5% Max.
Insulation resistance	@25°C: >100GΩ or >1000ΩF whichever is less @160°C: >1GΩ or >10ΩF whichever is less
Dielectric withstanding voltage	≤200V: 250% 201-500V: 150% or 500V whichever is greater >500V: 120% or 750V whichever is greater
Ageing rate:	< 2.0% per decade
Test parameters:	1KHz, 1.0 ±0.2 VRMS, 25°C

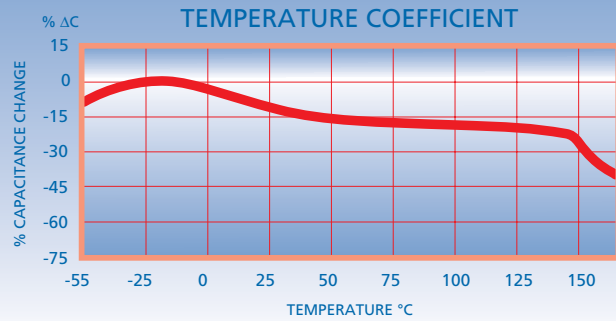

## Class II (E) Stable High Temperature (up to 200°C)

Operating temperature range:	-55°C to 200°C
Temperature coefficient up to 200°C:	+15 -65% ΔC Max.
Dissipation factor @ 25°C:	2.5% Max.
Insulation resistance	@25°C: >100GΩ or >1000ΩF whichever is less @200°C: >1GΩ or >10ΩF whichever is less
Dielectric withstanding voltage	≤200V: 250% 201-500V: 150% or 500V whichever is greater >500V: 120% or 750V whichever is greater
Ageing rate:	< 2.0% per decade
Test parameters:	1KHz, 1.0 ±0.2 VRMS, 25°C

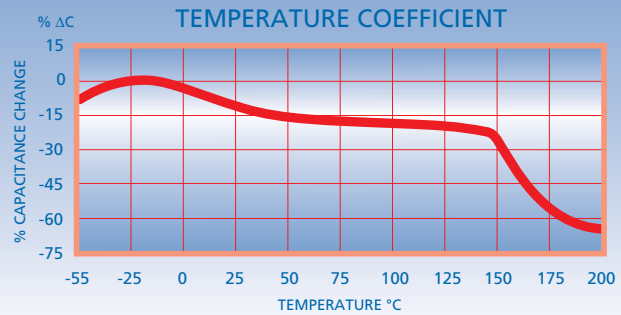

## X5R (W) Stable

Operating temperature range:	-55°C to 85°C
Temperature coefficient up to 200°C:	±15% ΔC Max.
Dissipation factor @ 25°C:	5% Max.
Insulation resistance @25%:	>10GΩ or >500ΩF whichever is less
Dielectric withstanding voltage:	250%
Ageing rate:	< 5.0% per decade
Test parameters:	1KHz, 1.0 ±0.2 VRMS, 25°C Except: 22μF, 47μF & 100μF 120KHz, 0.5 ±0.1 VRMS, 25°C

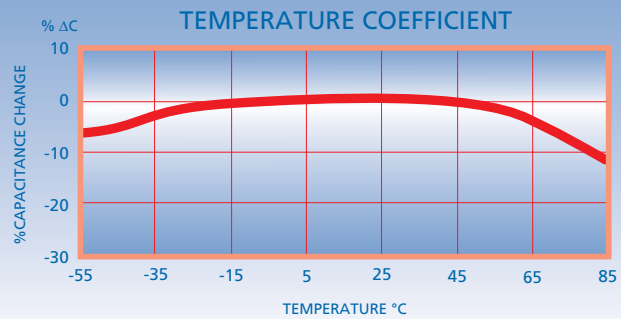

# Capacitor Manufacturing Process

## RoHS compliance

Novacap routinely monitors world wide material restrictions (e.g. EU / China and Korea RoHS mandates) and is actively involved in monitoring future legislation.

In an effort to meet the RoHS directives and its Recast aimed at reducing hazardous substances (Restriction of Hazardous Substances (RoHS) directive 2012/65/EU), Novacap has introduced new RoHS Lead-Free compliant lines. The new dielectric codes for these are "RN" for COG/NPO and "RB" for X7R. This is not a transition from the current product. The current product lines with dielectric codes "N" and "B" will not be phased out and can still be purchased. Please refer to our web site for further details.

Breakdown of material content, SGS analysis reports and tin whisker test results are available on request.

Most Novacap MLCC components are available with non RoHS compliant tin lead (SnPb) solderable termination finish by special request for exempt applications and where pure tin is not acceptable. Other tin free termination finishes may also be available – please refer to Novacap for further details.

Radial components have tin (Sn) plated leads as standard, but Sn/Pb leads are available as a special option. Please refer to the radial section of the catalog for further details.

## REACH (Registration, Evaluation, Authorization and restriction of Chemicals) statement

The main purpose of REACH is to improve the protection of human health and the environment from the risks arising from the use of chemicals.

Novacap maintains both ISO14001, Environmental Management System and OHSAS 18001 Health and Safety Management System approvals that require and ensure compliance with corresponding legislation such as REACH.

For further information, please contact the sales office.

## Novacap's "Green" Policy

It is Novacap policy to comply with the global environmental directives pertaining to the use of hazardous materials in manufacturing and to that end can supply products meeting RoHS standards – details can be found throughout this catalog.

## Process flow diagram for Novacap ceramic chip capacitors

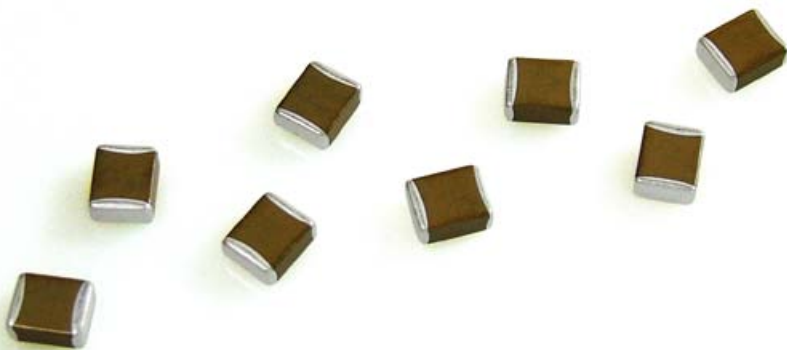
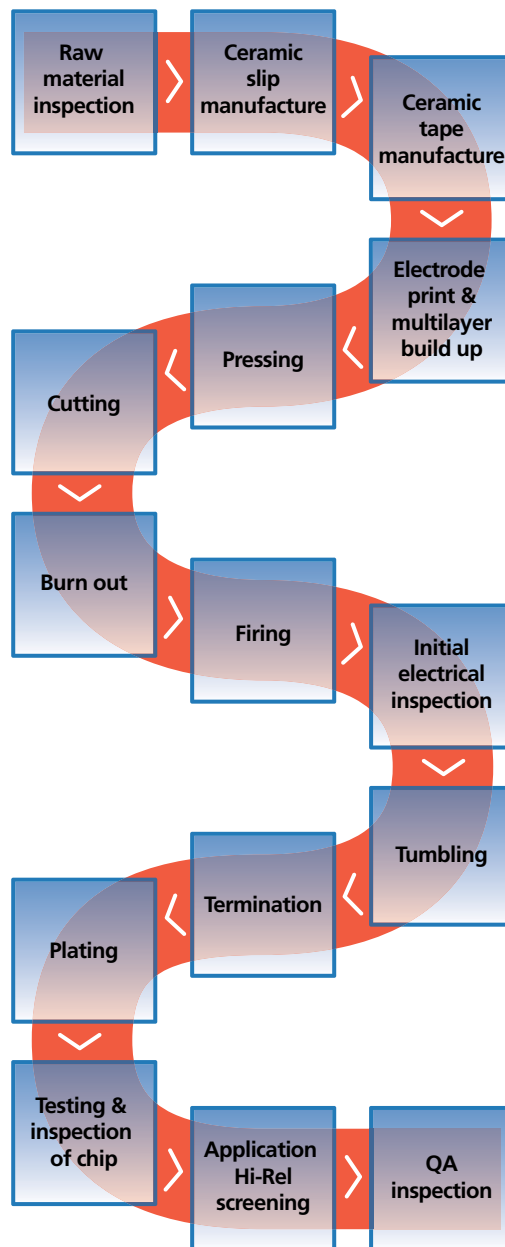

# MIL-PRF-123 Periodic Lot Testing



Test Name	Test Method	Details	Sample Size	Rejects Allowed
<b>Electrical Characteristics</b>				
Capacitance/Dissipation Factor	MIL-STD-202 M305	1Vrms, 1kHz	325	0
Insulation Resistance	MIL-STD-202 M302	Rated Voltage 1000 MΩ - μF min	325	0
Dielectric Withstanding Voltage	MIL-STD-202 M301	2.5x Rated Vdc min	325	0
<b>Group A - Subgroup 1</b>				
Thermal Shock	MIL-PRF-123 4.6.6.1 MIL-STD-202 M107	20 cycles -55°C to +125°C	325	5% PDA (16 pcs) and < 0.2% (0 pcs) in last 48 hrs
Voltage Conditioning	MIL-PRF-123 4.6.6.2	2x Rated Vdc, 125°C, 168-264 Hours		
<b>Group A - Subgroup 2</b>				
"Visual and mechanical inspection; material, physical dimensions, design, construction, marking and workmanship".	MIL-PRF-123 4.6.3	Parts must pass criteria	20	0
<b>Group A - Subgroup 3</b>				
Destructive Physical Analysis	MIL-PRF-123 4.6.11	Parts must pass criteria	10	0
<b>Group B - Subgroup 1</b>				
Thermal Shock	MIL-PRF-123 4.6.6.1 MIL-STD-202 M107	100 cycles -55°C to +125°C	200	Report
Life Test	MIL-PRF-123 4.6.19 MIL-STD-202 M108	2xVdc, 125°C, 1000 Hours		
<b>Group B - Subgroup 2</b>				
Humidity, Steady State Low Voltage	MIL-PRF-123 4.6.16.1 MIL-STD-202 M103	85% RH, 85°C, 240 Hrs, 1.3V	12	0
<b>Group B - Subgroup 3</b>				
Voltage - Temperature Limits	MIL-PRF-123 4.6.15	-55°C -25°C -125°C 1Vrms ±15%(X7R), ±30ppm (COG)	12	1
Moisture Resistance	MIL-PRF-123 4.6.16.2 MIL-STD-202 M106	20 cycles 25V 1st 10 cycles		
<b>Group C - Subgroup 2 Chip Devices</b>				
Terminal Strength	MIL-PRF-123 4.6.12.2 MIL-STD-202 M211	Pull test, nail leads, x-x kg	6	1
Solderability	MIL-PRF-123 4.6.13.2 MIL-STD-202 M208 J-STD 002C	8 Hr Steam Age, SAC305 at 255°C, 5 seconds, 95% coverage	6	
Resistance To Soldering Heat	MIL-PRF-123 4.6.14.2 MIL-STD-202 M210	60/40 Tin/Lead at 230°C, 2 five second dips	6	

COG and X7R test packages available on request.

Bonding of capacitors to substrates can be categorized into two methods, those involving solder, which are prevalent, and those using other materials, such as epoxies and thermo-compression or ultrasonic bonding with wire.

The amount of solder applied to the chip capacitor will influence the reliability of the device. Excessive solder can create thermal and tensile stresses on the component which could lead to fracturing of the chip or the solder joint itself. Insufficient or uneven solder application can result in weak bonds; rotation of the device off line or lifting of one terminal off the pad (tombstoning).

There are practical limitations on capacitor sizes that prohibit reliable direct mounting of chip capacitors larger than 2225 to a substrate. Without mechanical restriction, thermally induced stresses are released once the capacitor attains a steady state condition, at any given temperature. Capacitors bonded to substrates, however, will retain some stress, due primarily to the mismatch of expansion of the component to the substrate; the residual stress on the chip is also influenced by the ductility and hence the ability of the bonding medium to relieve the stress. Unfortunately, the thermal expansions of chip capacitors differ significantly from those of substrate materials. At 25°C to 300°C, capacitors typically range in expansion coefficient from  $8.3 \times 10^{-6}$  to  $12.2 \times 10^{-6}$  in/in/°C, while 99% Alumina is approximately  $6.0 \times 10^{-6}$  in/in/°C and P.C. board is typically  $16.0 \times 10^{-6}$  in/in/°C.

## Soldering

The volume of solder is process and board pad size dependent. Soldering methods commonly used in the industry, and recommended, are Reflow Soldering, Wave Soldering, and to a lesser extent, Vapor Phase Soldering. All these methods involve thermal cycling of the components and

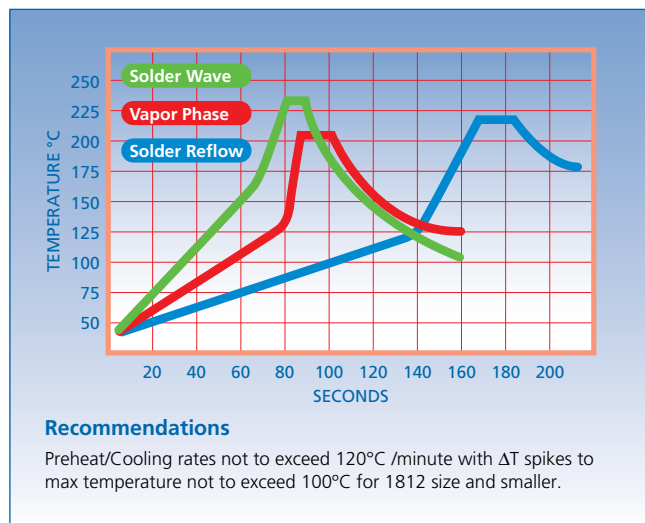

therefore the rate of heating and cooling must be controlled to preclude thermal shocking of the devices. In general, rates which do not exceed 120°C per minute and a T spike of 100°C maximum for any soldering process on sizes 1812 and smaller is advisable. Other precautions include post soldering handling, primarily avoidance of rapid cooling with contact with heat sinks, such as conveyors or cleaning solutions.

Wave Soldering exposes the devices to a large solder volume; hence the pad size area must be restricted to accept an amount of solder which is not detrimental to the chip size utilized. Typically the pad width is 66% of the component width, and the length is .030" (.760 mm) longer than the termination band on the chip. For example, an 0805 chip which is .050" wide and has a .020" termination band therefore requires a pad .033" wide by .050" in length. Opposing pads should be identical in size to preclude uneven solder fillets and mismatched surface tension forces which can misalign the device. It is preferred that the pad layout results in alignment of the long axis of the chips at right angles to the solder wave, to promote even wetting of all terminals. Orientation of components in line with the board travel direction may require dual waves with solder turbulence to preclude cold solder joints on the trailing terminals of the devices, as these are blocked from full exposure to the solder by the body of the capacitor.

Novacap publishes a technical brochure which provides detailed information on the properties of ceramic chip capacitors, dielectric behavior, product classifications, test and quality standards, and other information relevant to their use. The Novacap technical brochure is available upon request. For quick reference see the brochure on the Novacap website at [www.novacap.com](http://www.novacap.com)

Restrictions in chip alignment do not apply to Solder Reflow or Vapor Phase processes, where the solder volume is controlled by the solder paste deposition on the circuit pads. Novacap has adopted the IPC-SM-782 methodology for solder reflow land patterns. The Novacap recommended solder pads brochure is available for reference on our website. Large chips are more prone to thermal shock as their greater bulk will result in sharper thermal gradients within the device during thermal cycling. Units larger than 1812 experience excessive stress if processed through the fast cycles typical of solder wave or vapor phase operations. Solder reflow is most applicable to the larger chips as the rates of heating and cooling can be slowed within safe limits.

Attachment using a soldering iron requires extra care, particularly with large components, as thermal gradients are not easily controlled and may cause cracking of the chip. Precautions include preheating of the assembly to within 100°C of the solder flow temperature; the use of a fine tip iron which does not exceed 30 watts and limitation of contact of the iron to the circuit pad areas only.

## Bonding

Hybrid assembly using conductive epoxy or wire bonding requires the use of silver palladium or gold terminations. Nickel barrier termination is not practical in these applications, as intermetallics will form between the dissimilar metals. The ESR will increase over time and may eventually break contact when exposed to temperature cycling.

## Cleaning

Chip capacitors can withstand common agents such as water, alcohol and degreaser solvents used for cleaning boards. Ascertain that no flux residues are left on the chip surfaces as these diminish electrical performance.

# FlexiCap™ Polymer Termination



## FlexiCap™ termination

MLCCs are widely used in electronic circuit design for a multitude of applications. Their small package size, technical performance and suitability for automated assembly makes them the component of choice.

However, despite the technical benefits, ceramic components are brittle and need careful handling on the production floor.

In some circumstances they may be prone to mechanical stress damage if not used in an appropriate manner. Board flexing, depanelization, mounting through hole components, poor storage and automatic circuit testing may all result in cracking.

Careful process control is important at all stages of circuit board assembly and transportation - from component placement to test and packaging. Any significant board flexing may result in stress fractures in ceramic devices that may not always be evident during the board assembly process. Sometimes it may be the end customer who finds out - when equipment fails!

## The solution - FlexiCap™

FlexiCap™ was developed as a result of listening to customers' experiences of stress damage to MLCCs from many manufacturers, often caused by variations in production processes.

Our answer is a proprietary flexible epoxy polymer termination material, that is applied to the device under the usual nickel barrier finish. FlexiCap™ will accommodate a greater degree of board bending than conventional capacitors.

## FlexiCap™ termination

All capacitance ranges are available with FlexiCap™ termination material offering increased reliability and superior mechanical performance (board flex and temperature cycling) when compared with standard termination materials. FlexiCap™ capacitors enable the board to be bent almost twice as much before mechanical cracking occurs.

FlexiCap™ is also suitable for Space applications having passed thermal vacuum outgassing tests.

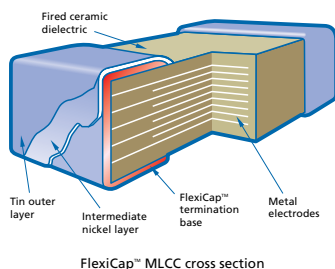

## FlexiCap™ benefits

With traditional termination materials and assembly, the chain of materials from bare PCB to soldered termination, provides no flexibility. In circumstances where excessive stress is applied - the weakest link fails. This means the ceramic itself may fail.

The benefit to the user is to facilitate a wider process window - giving a greater safety margin and substantially reducing the typical root causes of mechanical stress cracking.

FlexiCap™ may be soldered using your traditional wave or reflow solder techniques and needs no adjustment to equipment or current processes.

Novacap has delivered millions of FlexiCap™ components and during that time has collected substantial test and reliability data, working in partnership with customers world wide, to eliminate mechanical cracking.

An additional benefit of FlexiCap™ is that MLCCs can withstand temperature cycling -55°C to 125°C in excess of 1,000 times without cracking.

FlexiCap™ termination has no adverse effect on any electrical parameters, nor affects the operation of the MLCC in any way.

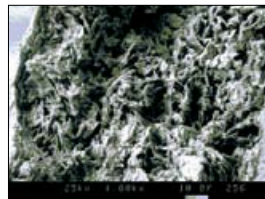

● Picture taken at 1,000x magnification using a SEM to demonstrate the fibrous nature of the FlexiCap™ termination that absorbs increased levels of mechanical stress.

Available on the following ranges:

- All High Reliability ranges
- Standard and High Voltage chips
- X8R High Temperature capacitors

## Summary of PCB bend test results

The bend tests conducted on X7R have proven that the FlexiCap™ termination withstands a greater level of mechanical stress before mechanical cracking occurs.

The AEC-Q200 test for X7R requires a bend level of 2mm minimum and a cap change of less than 10%.

Product X7R	Typical bend performance under AEC-Q200 test conditions
Standard termination	2mm to 3mm
FlexiCap™ termination	Typically 8mm to 10mm

## Application notes

FlexiCap™ may be handled, stored and transported in the same manner as standard terminated capacitors. The requirements for mounting and soldering FlexiCap™ are the same as for standard SMD capacitors.

For customers currently using standard terminated capacitors there should be no requirement to change the assembly process when converting to FlexiCap™.

Based upon board bend tests in accordance with IEC 60384-1 the amount of board bending required to mechanically crack a FlexiCap™ terminated capacitor is significantly increased compared with standard terminated capacitors.

It must be stressed however, that capacitor users must not assume that the use of FlexiCap™ terminated capacitors will totally eliminate mechanical cracking. Good process controls are still required for this objective to be achieved.

Product not available for 200°C applications.

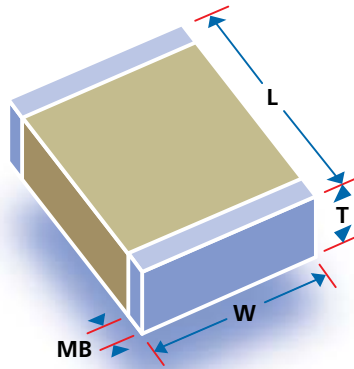

## Dimensions - inches (mm)

Size	Length (L)	Width (W)	Max. Thickness (T)*	Termination Band (MB)
<b>0402</b>	0.040 ± 0.004 (1.02 ± 0.102)	0.020 ± 0.004 (0.508 ± 0.102)	0.024 (0.610)	0.010 ± 0.006 (0.254 ± 0.152)
<b>0504</b>	0.050 ± 0.006 (1.27 ± 0.152)	0.040 ± 0.006 (1.02 ± 0.152)	0.044 (1.12)	0.014 ± 0.006 (0.356 ± 0.152)
<b>RF0505</b>	0.055 +0.015 -0.010 (1.4 +0.38 -0.25)	0.055 ± 0.015 (1.40 ± 0.381)	0.057 (1.45)	0.014 ± 0.006 (0.356 ± 0.152)
<b>0603</b>	0.060 ± 0.006 (1.52 ± 0.152)	0.030 ± 0.006 (0.762 ± 0.152)	0.035 (0.889)	0.014 ± 0.006 (0.356 ± 0.152)
<b>0805</b>	0.080 ± 0.008 (2.03 ± 0.203)	0.050 ± 0.008 (1.27 ± 0.203)	0.054 (1.37)	0.020 ± 0.010 (0.508 ± 0.254)
<b>0907</b>	0.090 ± 0.008 (2.29 ± 0.203)	0.070 ± 0.008 (1.78 ± 0.203)	0.060 (1.52)	0.020 ± 0.010 (0.508 ± 0.254)
<b>1005</b>	0.100 ± 0.008 (2.54 ± 0.203)	0.050 ± 0.008 (1.27 ± 0.203)	0.054 (1.37)	0.020 ± 0.010 (0.508 ± 0.254)
<b>RF1111</b>	0.110+0.025 -0.010 (2.79 +0.64 -0.25)	0.110 ± 0.015 (2.79 ± 0.381)	0.102 (2.59)	0.020 ± 0.010 (0.508 ± 0.254)
<b>1206</b>	0.125 ± 0.008 (3.18 ± 0.203)	0.060 ± 0.008 (1.52 ± 0.203)	0.064 (1.63)	0.020 ± 0.010 (0.508 ± 0.254)
<b>1210</b>	0.125 ± 0.008 (3.18 ± 0.203)	0.100 ± 0.008 (2.54 ± 0.203)	0.065 (1.65)	0.020 ± 0.010 (0.508 ± 0.254)
<b>1515</b>	0.150 ± 0.015 (3.81 ± 0.381)	0.150 ± 0.015 (3.81 ± 0.381)	0.130 (3.30)	0.030 ± 0.015 (0.762 ± 0.381)
<b>1808</b>	0.180 ± 0.012 (4.57 ± 0.305)	0.080 ± 0.008 (2.03 ± 0.203)	0.065 (1.65)	0.024 ± 0.014 (0.610 ± 0.356)
<b>1812</b>	0.180 ± 0.012 (4.57 ± 0.305)	0.125 ± 0.008 (3.18 ± 0.203)	0.065 (1.65)	0.024 ± 0.014 (0.610 ± 0.356)
<b>1825</b>	0.180 ± 0.012 (4.57 ± 0.305)	0.250 ± 0.015 (6.35 ± 0.381)	0.080 (2.03)	0.024 ± 0.014 (0.610 ± 0.356)
<b>2020</b>	0.200 ± 0.015 (5.08 ± 0.381)	0.200 ± 0.015 (5.08 ± 0.381)	0.180 (4.57)	0.024 ± 0.014 (0.610 ± 0.356)
<b>2221</b>	0.220 ± 0.015 (5.59 ± 0.381)	0.210 ± 0.015 (5.33 ± 0.381)	0.080 (2.03)	0.030 ± 0.015 (0.762 ± 0.381)
<b>2225</b>	0.220 ± 0.015 (5.59 ± 0.381)	0.250 ± 0.015 (6.35 ± 0.381)	0.080 (2.03)	0.030 ± 0.015 (0.762 ± 0.381)
<b>2520</b>	0.250 ± 0.015 (6.35 ± 0.381)	0.200 ± 0.015 (5.08 ± 0.381)	0.180 (4.57)	0.030 ± 0.015 (0.762 ± 0.381)
<b>RF2525</b>	0.230 +0.020 -0.012 (5.84 +0.51 -0.30)	0.250 ± 0.015 (6.35 ± 0.381)	0.165 (4.19)	0.030 ± 0.015 (0.762 ± 0.381)
<b>3333</b>	0.330 ± 0.017 (8.38 ± 0.432)	0.330 ± 0.017 (8.38 ± 0.432)	0.250 (6.35)	0.030 ± 0.015 (0.762 ± 0.381)
<b>3530</b>	0.350 ± 0.018 (8.89 ± 0.457)	0.300 ± 0.015 (7.62 ± 0.381)	0.250 (6.35)	0.030 ± 0.015 (0.762 ± 0.381)
<b>4040</b>	0.400 ± 0.020 (10.2 ± 0.508)	0.400 ± 0.020 (10.2 ± 0.508)	0.300 (7.62)	0.040 ± 0.020 (1.02 ± 0.508)
<b>4540</b>	0.450 ± 0.023 (11.4 ± 0.584)	0.400 ± 0.020 (10.2 ± 0.508)	0.300 (7.62)	0.040 ± 0.020 (1.02 ± 0.508)
<b>5440</b>	0.540 ± 0.027 (13.7 ± 0.686)	0.400 ± 0.020 (10.2 ± 0.508)	0.300 (7.62)	0.040 ± 0.020 (1.02 ± 0.508)
<b>5550</b>	0.550 ± 0.028 (14.0 ± 0.711)	0.500 ± 0.025 (12.7 ± 0.635)	0.300 (7.62)	0.040 ± 0.020 (1.02 ± 0.508)
<b>6560</b>	0.650 ± 0.033 (16.5 ± 0.838)	0.600 ± 0.030 (15.2 ± 0.762)	0.300 (7.62)	0.040 ± 0.020 (1.02 ± 0.508)
<b>7565</b>	0.750 ± 0.038 (19.1 ± 0.965)	0.650 ± 0.033 (16.5 ± 0.838)	0.300 (7.62)	0.040 ± 0.020 (1.02 ± 0.508)

\* Non standard thicknesses are available - consult the sales office for details.

# Chip Marking System



If required, we can mark capacitors with the EIA 198 two digit code to show the capacitance value of the part. On chips larger than 3333, or for leaded encapsulated devices, ink marking is available. However, for chip sizes 0805 through to 3333 identification marking is accomplished by using either laser or ink jet printer. This system does not degrade the ceramic surface, or induce microcracks in the part.

Marking for other sizes may be available upon special request to determine if applicable; please contact the sales office.

Marking is an option, and needs to be specified when ordering by using the letter M in the part number code, see page 15 for details.



Two position alpha numeric marking is available on chip sizes 0805 through 3333.

The marking denotes retma value and significant figures of capacitance (see table) eg: A5 = 100,000pF.

Three position alpha numeric marking is available on chip sizes 1206 and larger.

The making denotes Novacap as vendor (N), followed by the standard two digit alpha numeric identification.

## Marking Code - value in picofarads for alpha-numeric code

Number	0	1	2	3	4	5	6	7	
Letter	A	1.0	10	100	1,000	10,000	100,000	1,000,000	10,000,000
	B	1.1	11	110	1,100	11,000	110,000	1,100,000	11,000,000
	C	1.2	12	120	1,200	12,000	120,000	1,200,000	12,000,000
	D	1.3	13	130	1,300	13,000	130,000	1,300,000	13,000,000
	E	1.5	15	150	1,500	15,000	150,000	1,500,000	15,000,000
	F	1.6	16	160	1,600	16,000	160,000	1,600,000	16,000,000
	G	1.8	18	180	1,800	18,000	180,000	1,800,000	18,000,000
	H	2.0	20	200	2,000	20,000	200,000	2,000,000	20,000,000
	J	2.2	22	220	2,200	22,000	220,000	2,200,000	22,000,000
	K	2.4	24	240	2,400	24,000	240,000	2,400,000	24,000,000
	L	2.7	27	270	2,700	27,000	270,000	2,700,000	27,000,000
	M	3.0	30	300	3,000	30,000	300,000	3,000,000	30,000,000
	N	3.3	33	330	3,300	33,000	330,000	3,000,000	33,000,000
	P	3.6	36	360	3,600	36,000	360,000	3,600,000	36,000,000
	Q	3.9	39	390	3,900	39,000	390,000	3,900,000	39,000,000
	R	4.3	43	430	4,300	43,000	430,000	4,300,000	43,000,000
	S	4.7	47	470	4,700	47,000	470,000	4,700,000	47,000,000
	T	5.1	51	510	5,100	51,000	510,000	5,100,000	51,000,000
	U	5.6	56	560	5,600	56,000	560,000	5,600,000	56,000,000
	V	6.2	62	620	6,200	62,000	620,000	6,200,000	62,000,000
	W	6.8	68	680	6,800	68,000	680,000	6,800,000	68,000,000
	X	7.5	75	750	7,500	75,000	750,000	7,500,000	75,000,000
	Y	8.2	82	820	8,200	82,000	820,000	8,200,000	82,000,000
	Z	9.1	91	910	9,100	91,000	920,000	9,200,000	92,000,000
	a	2.5	25	250	2,500	25,000	250,000	2,500,000	25,000,000
	b	3.5	35	350	3,500	35,000	350,000	3,500,000	35,000,000
d	4.0	40	400	4,000	40,000	400,000	4,000,000	40,000,000	
e	4.5	45	450	4,500	45,000	450,000	4,500,000	45,000,000	
f	5.0	50	500	5,000	50,000	500,000	5,000,000	50,000,000	
m	6.0	60	600	6,000	60,000	600,000	6,000,000	60,000,000	
n	7.0	70	700	7,000	70,000	700,000	7,000,000	70,000,000	
t	8.0	80	800	8,000	80,000	800,000	8,000,000	80,000,000	
y	9.0	90	900	9,000	90,000	900,000	9,000,000	90,000,000	

# Chip Tape and Reel Details

Novacap chip capacitors are available packaged in 8mm to 24mm embossed carrier, per EIA 481. Specify the reeled option (T) in the Novacap part number code. Chips are also supplied in bulk or waffle pack.

Units per reel (typical)				
Chip size	Tape width	Tape pocket pitch	Units per reel*	
			7" (178mm) dia.	13" (330mm) dia.
0402	8 mm	2 mm	10,000	•
0504	8 mm	4 mm	3,000-4,000	15,000
0603	8 mm	4 mm	3,000-4,000	15,000
0805	8 mm	4 mm	3,000-4,000	15,000
1005	8 mm	4 mm	2,000-4,000	15,000
1206	8 mm	4 mm	2,000-4,000	15,000
1210	8 mm	4 mm	2,000-3,000	10,000
1505	12 mm	4 mm	2,000-3,000	10,000
1808	12 mm	4 mm	2,000-3,000	10,000
1812	12 mm	8 mm	1,000	10,000
1825	12 mm	8 mm	1,000	5,000
2221	12 mm	8 mm	1,000	5,000
2225	12 mm	8 mm	1,000	5,000
2628	16 mm	12 mm	•	1,000
3333	16 mm	12 mm	•	1,000
3530	16 mm	12 mm	•	1,000
4040	16 mm	12 mm	•	1,000

\* Quantity per reel varies with chip thickness. Thicker chips (typically higher capacitance values) will result in lesser quantities. Please specify preferred reel size when ordering.

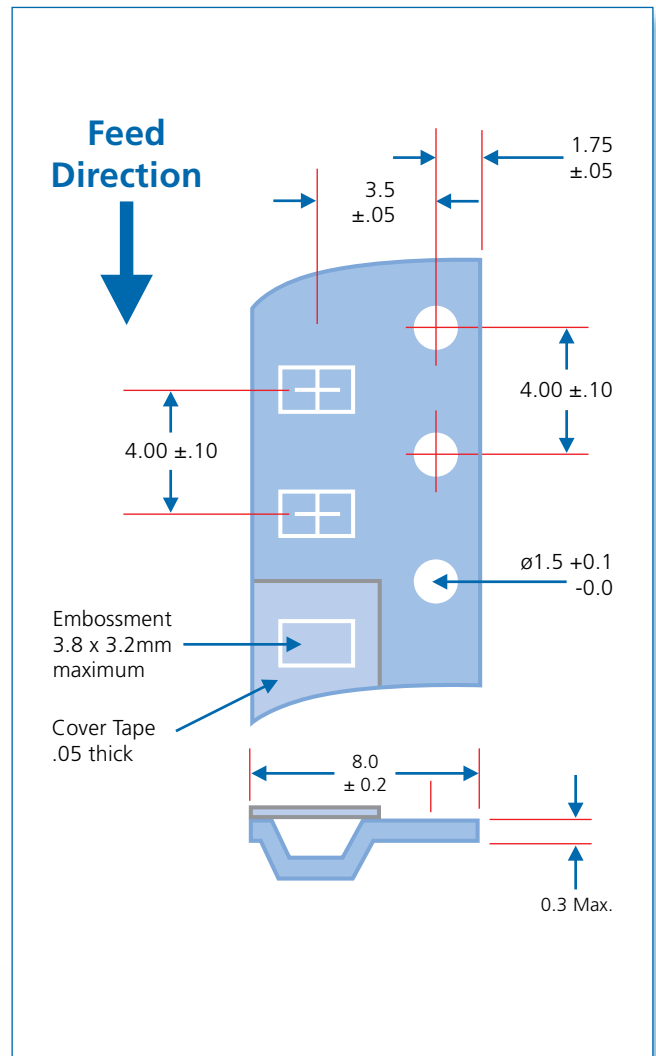

Dimensions for 8mm tape with 4mm pitch.

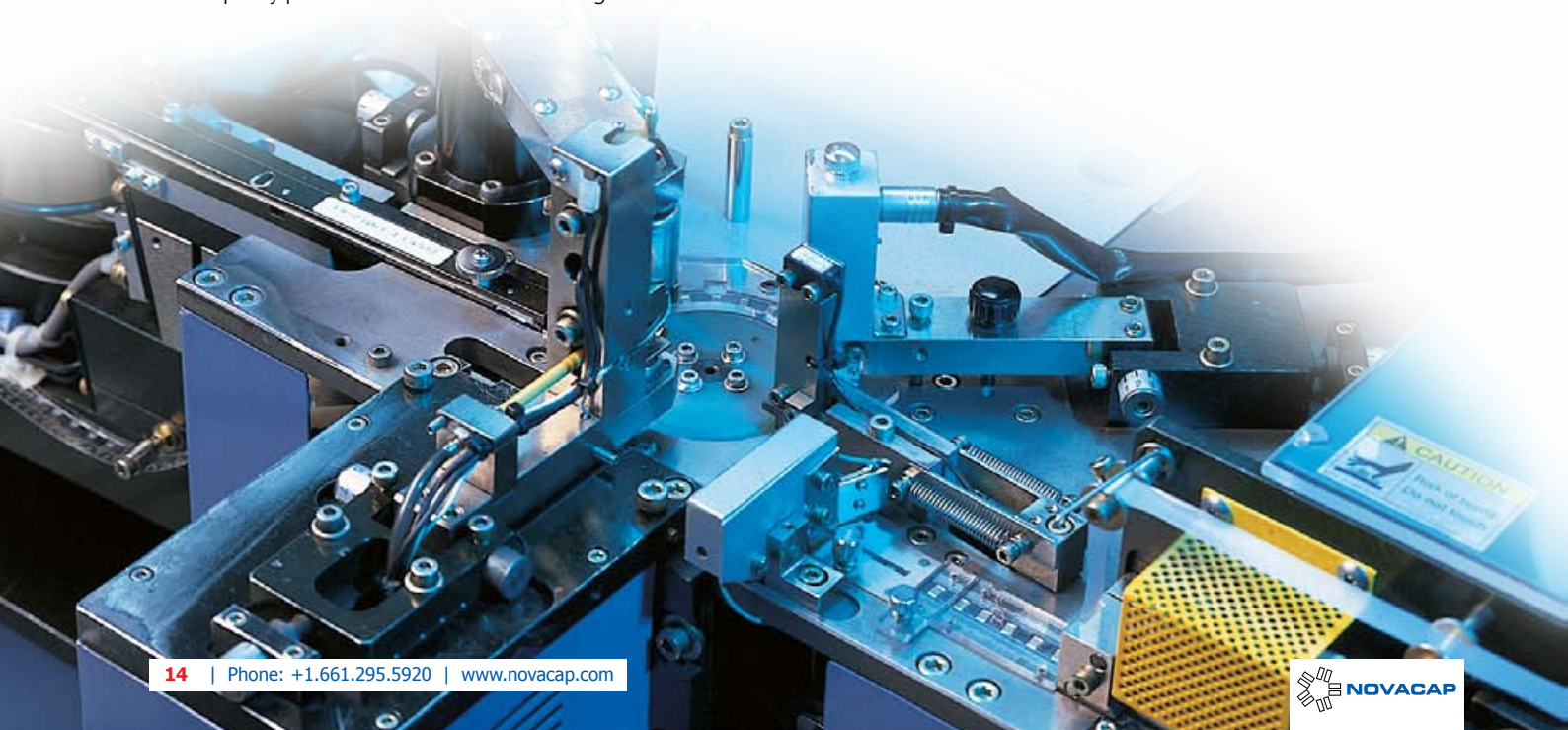



# Chip Ordering Information

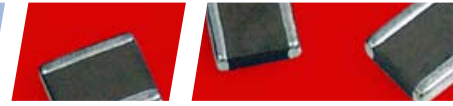

Prefix	Case Size	Dielectric	Capacitance	Capacitance Tolerance	Voltage	Termination	Special Thickness	High Reliability Testing	Packaging	Marking	High Reliability Test Criteria
XX	1206	N	472	J	101	N	X050	H	T	M	HB

### Capacitance Code

1st two digits are significant, third digit denotes number of zeros, R = decimal  
Examples:

1R0	= 1.0pF
120	= 12pF
471	= 470pF
102	= 1,000pF
273	= 0.027μF
474	= 0.47μF
105	= 1.0μF

### Special Thickness

None	Standard thickness as per Novacap catalog specifications
X	Denotes a special thickness other than standard. Specify in inches if required. (As shown above X = 0.050")

### Packaging

None	Bulk
T	Tape & Reel
W	Waffle Pack

### Marking

None	Unmarked
M	Marked *Marking not available on sizes ≤ 0603

### High Reliability Testing

None	Standard product
H	High Reliability Testing
H	High Temp Screening

### Hi-Reliability Testing Criteria

HB	MIL-PRF-55681 Group A
HV	MIL-PRF-49467 Group A
HS	MIL-PRF-123 Group A

### Dielectric Codes

N	C0G/NP0	Ultra Stable
M	C0G/NP0	Ultra Stable Magnetic Free
F	C0G/NP0	High Temp. (up to 160°C)
D	C0G/NP0	High Temp. (up to 200°C)
K	R3L	Ultra Stable
R	R2D	Pulse Energy
Y	Y5V	General Purpose
Z	Z5U	General Purpose
B	X7R	Stable
C	X7R	Stable Magnetic Free
X	BX	MIL
S	X8R	High Temp. (up to 150°C)
E	Class II	High Temp. (up to 200°C)
G	Class II	High Temp. (up to 160°C)
W	X5R	Stable
RN	Lead free C0G/NP0	Ultra Stable
RB	Lead free X7R	Stable
BB	X7R BME	Stable
BW	X5R BME	Stable

### Voltage Code

1st two digits are significant, third digit denotes number of zeros. For example:

160	= 16 Volts
101	= 100 Volts
501	= 500 Volts
102	= 1,000 Volts
502	= 5,000 Volts
103	= 10,000 Volts

### Termination Codes

P	Palladium Silver	
PR	Palladium Silver*	
K	Solderable Palladium Silver*	
N	Nickel Barrier*	100% tin
Y	Nickel Barrier	90% tin, 10% lead
NG	Nickel Barrier Gold Flash*	
C	FlexiCap™/Nickel Barrier*	100% tin
D	FlexiCap™/Nickel Barrier	90% tin, 10% lead
B	Copper Barrier*	100% tin
E	Copper Barrier	90% tin, 10% lead
S	Silver*	

\* Indicates RoHS terminations

### Capacitance Tolerance Codes

Code	Tolerance	Capacitance Tolerance Codes												
		C0G/NP0			R3L	R2D	Y5V/Z5U	X7R	BX	X8R	Class II	X5R	Positive VTC	
	* Not RF series	N	M	F/D	K	R	Y/Z	B	C	X	S	E/G	W	P
B	±0.10pF	•	•											
C	±0.25pF	•	•		•									
D	±0.50pF	•	•		•									
F	±1%	•	•	•										
G	±2%	•	•	•	•									
J	±5%	•	•	•	•	•		•*	•	•*	•	•		
K	±10%	•	•	•	•	•		•	•	•	•	•	•	•
M	±20%	•		•	•	•	•	•	•	•	•	•	•	•
Z	+80% -20%	•				•	•	•*						•
P	+100% -0%	•				•	•	•*						•

### Prefix Definitions

None	Standard chip	
RF	Improved ESR Capacitor	p. 23
LS	Y <sup>3</sup> Certified Safety Capacitor	p. 42 - 43
ES	Y <sup>2</sup> Certified Safety Capacitor	p. 42 - 43
ST	Stacked Capacitor Assembly	p. 48 - 53
SM	Stacked Hi-Rel Capacitor Assembly	p. 48 - 53
CR	Cap-Rack Capacitor Array	p. 54
RC	Bleed Resistor	p. 58 - 61

# Commercial Chip - COG 16Vdc to 10kVdc

A range of commercial MLC chip capacitors in Ultra stable EIA Class I COG, or NP0, dielectric. COG chips are used in precision circuitry requiring Class I stability and exhibit linear temperature coefficient, low loss and stable electrical properties with time, voltage and frequency.

Designed for surface mount application with nickel barrier terminations making them suitable for solder wave and reflow solder board attachment as well as vapor phase attachment for part sizes 2225 or smaller. Silver-palladium terminations are also available for hybrid use with conductive epoxy.

Standard EIA case sizes and available C/V values are listed below - special sizes, thicknesses and other voltage ratings are available; please contact the sales office for information.



## Capacitance and voltage selection for popular chip sizes

Size	0402	0504	0603	0805	1005	1206	1210	1515	1808	1812	1825			
Min cap.	0R3	0R5	0R3	0R5	0R5	3R0	5R0	3R0	5R0	5R0	100	100	150	150
Tmax inches: mm:	0.024 0.61	0.044 1.12	0.035 0.89	0.054 1.37	0.054 1.37	0.064 1.63	0.065 1.63	0.130 3.02	0.065 1.63	0.080* 2.03	0.065 1.63	0.100* 2.54	0.080 2.03	0.140* 3.56
16V	271	222	152	562	822	153	273	473	393	393	563	563	104	104
25V	221	182	122	472	682	123	273	393	333	333	563	563	104	104
50V	181	152	102	392	562	123	223	333	223	273	393	393	104	104
100V	181	152	102	392	562	103	183	333	153	223	273	393	683	823
200V	101	821	561	182	272	562	103	223	103	153	183	273	473	683
250V	560	561	331	152	222	392	822	223	682	103	153	223	393	563
300V	•	•	•	821	122	272	472	153	472	562	103	153	223	473
400V	•	•	•	821	122	182	472	103	472	472	103	123	223	333
500V	•	•	•	821	122	182	392	822	472	472	103	123	223	273
600V	•	•	•	681	102	152	332	682	392	472	822	103	183	183
800V†	•	•	•	681	102	152	332	682	392	472	822	103	183	183
1kV†	•	•	•	471	391	102	222	562	222	332	472	822	103	153
1.5kV†	•	•	•	•	•	561	122	392	122	182	272	472	562	103
2kV†	•	•	•	•	•	391	821	272	821	122	182	272	272	562
3kV†	•	•	•	•	•	•	•	122	391	471	821	122	122	222
4kV†	•	•	•	•	•	•	•	681	221	271	471	821	681	122
5kV†	•	•	•	•	•	•	•	•	•	•	•	•	391	821
6kV†	•	•	•	•	•	•	•	•	•	•	•	•	•	•
7kV†	•	•	•	•	•	•	•	•	•	•	•	•	•	•
8kV†	•	•	•	•	•	•	•	•	•	•	•	•	•	•
9kV†	•	•	•	•	•	•	•	•	•	•	•	•	•	•
10kV†	•	•	•	•	•	•	•	•	•	•	•	•	•	•

† Units rated above 800V may require conformal coating to preclude arcing over chip surface



# Commercial Chip - COG 16Vdc to 10kVdc



- For dielectric characteristics see page 4.
- For dimensions see page 12.
- For termination options see pages 3 & 15.
- For capacitance tolerances available see page 15.
- For ordering information see page 15.

**Note:** Maximum capacitance values are shown below as 3 digit code: 2 significant figures followed by the no. of zeros e.g. 183 = 18,000pF. R denotes decimal e.g. 2R7 = 2.7pF.



## Capacitance and voltage selection for popular chip sizes

	2020	2221	2225		2520	3333	3530	4040	4540	5440	5550	6560	7565	Size	
	270	270	270	270	390	390	390	390	390	390	390	560	101	Min cap.	
	0.180 4.57	0.080 2.03	0.080 2.03	0.150* 3.81	0.180 4.57	0.250 6.35	0.250 6.35	0.300 7.62	0.300 7.62	0.300 7.62	0.300 7.62	0.300 7.62	0.300 7.62	inches mm	Tmax
	683	104	124	124	104	184	184	334	334	394	394	684	824	16V	
	683	104	124	124	104	184	184	334	334	394	394	684	824	25V	
	683	104	124	124	104	154	184	274	334	394	394	684	824	50V	
	563	683	823	104	823	124	154	224	274	274	274	474	564	100V	
	563	473	563	823	683	104	124	184	224	274	274	474	564	200V	
	473	393	473	683	563	104	124	184	204	224	224	394	474	250V	
	393	223	273	563	473	823	104	154	184	224	224	394	474	300V	
	333	223	273	393	393	563	823	124	154	184	184	334	394	400V	
	273	223	273	333	393	473	683	104	124	154	184	274	334	500V	
	153	183	273	273	223	393	393	823	823	104	154	224	274	600V	
	153	183	273	273	183	333	333	563	683	823	124	184	224	800V <sup>†</sup>	
	103	103	153	223	123	273	273	563	563	683	104	154	184	1kV <sup>†</sup>	
	822	562	822	153	103	183	223	393	393	393	563	823	124	1.5kV <sup>†</sup>	
	472	272	392	822	562	153	153	273	333	333	473	683	104	2kV <sup>†</sup>	
	222	122	182	332	272	822	103	183	223	223	333	473	683	3kV <sup>†</sup>	
	122	681	102	182	152	332	562	123	123	123	183	273	393	4kV <sup>†</sup>	
	821	391	561	122	102	222	332	682	822	822	123	183	223	5kV <sup>†</sup>	
	•	•	•	•	•	182	182	392	392	472	562	103	123	6kV <sup>†</sup>	
	•	•	•	•	•	•	122	272	272	332	472	682	822	7kV <sup>†</sup>	
	•	•	•	•	•	•	102	222	222	272	332	562	682	8kV <sup>†</sup>	
	•	•	•	•	•	•	821	152	182	182	272	392	472	9kV <sup>†</sup>	
	•	•	•	•	•	•	681	122	152	152	222	332	392	10kV <sup>†</sup>	

\* Denotes non standard chip thickness.  
Order code needs to have an 'X' inserted together with the dimension in inches e.g. X080 where dimension is 0.080"

# Commercial Chip - R3L 16Vdc to 5kVdc

A range of commercial MLC chip capacitors in R3L dielectric. This is a Class I temperature compensating N2200 dielectric with an energy density that exceeds conventional Class I materials. R3L has a predictable negative temperature coefficient, low loss, stable electrical properties with time, voltage, and frequency. The components are non-piezoelectric and are well suited for repetitive high current and pulse type applications. With exceptionally low ESR, ESL, and low signal distortion applications include power supply filtering, energy storage, coupling/decoupling and snubber.

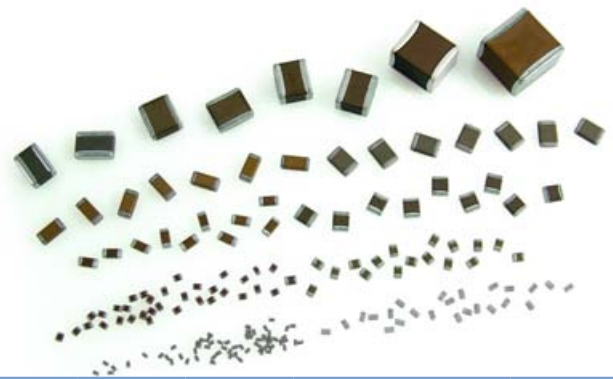

## Capacitance and voltage selection for popular chip sizes

Size	0402	0504	0603	0805	1206	1210	1515	1808	1812	1825	2020
Min cap.	1R5	2R2	2R2	2R2	8R2	220	220	220	390	680	101
Tmax inches: mm:	0.024 0.61	0.044 1.12	0.035 0.89	0.054 1.37	0.064 1.63	0.065 1.63	0.130 3.02	0.065 1.63	0.065 1.63	0.080 2.03	0.180 4.57
16V	391	472	222	103	223	473	823	473	104	184	154
25V	391	472	222	103	223	473	823	473	104	184	154
50V	391	472	222	103	223	393	683	333	683	184	154
100V	391	472	222	103	223	393	683	333	683	154	124
200V	221	272	122	472	123	223	473	223	393	104	104
250V	121	152	821	332	103	183	473	183	333	823	823
300V	•	•	•	222	562	123	333	103	223	563	683
400V	•	•	•	182	392	103	223	103	223	563	683
500V	•	•	•	182	392	822	223	822	183	473	563
600V	•	•	•	152	272	682	123	682	153	333	393
800V†	•	•	•	821	152	392	103	392	103	153	223
1kV†	•	•	•	471	102	222	822	222	562	123	153
1.5kV†	•	•	•	•	471	122	392	122	272	682	103
2kV†	•	•	•	•	271	561	182	561	122	332	562
3kV†	•	•	•	•	•	•	102	271	681	152	272
4kV†	•	•	•	•	•	•	471	151	331	821	152
5kV†	•	•	•	•	•	•	•	•	•	561	102

† Units rated above 800V may require conformal coating to preclude arcing over chip surface

# Commercial Chip - R3L 16Vdc to 5kVdc

- For dielectric characteristics see page 5.
- For dimensions see page 12.
- For termination options see pages 3 & 15.
- For capacitance tolerances available see page 15.
- For ordering information see page 15.

**Note:** Maximum capacitance values are shown below as 3 digit code: 2 significant figures followed by the no. of zeros e.g. 183 = 18,000pF. R denotes decimal e.g. 2R7 = 2.7pF.

## Capacitance and voltage selection for popular chip sizes

	2221	2225	2520	3333	3530	4040	4540	5440	5550	6560	7565	Size
	101	101	101	151	151	151	151	151	151	221	391	Min cap.
	0.080 2.03	0.080 2.03	0.180 4.57	0.250 6.35	0.250 6.35	0.300 7.62	0.300 7.62	0.300 7.62	0.300 7.62	0.300 7.62	0.300 7.62	.inches Tmax .mm
	184	224	224	334	334	564	564	684	824	125	185	16V
	184	224	184	334	334	564	564	684	824	125	185	25V
	184	224	184	334	334	564	564	684	824	125	185	50V
	154	184	184	334	334	474	564	684	824	125	155	100V
	104	124	154	224	224	394	394	474	684	105	125	200V
	823	104	124	184	184	334	334	394	564	824	105	250V
	563	683	104	184	184	274	274	334	474	684	824	300V
	473	563	823	154	154	224	224	274	394	564	684	400V
	393	473	683	124	124	224	224	274	334	474	564	500V
	333	393	563	104	104	184	184	224	274	394	474	600V
	223	273	393	563	563	104	124	124	184	274	334	800V <sup>†</sup>
	123	153	223	473	473	823	104	104	154	224	274	1kV <sup>†</sup>
	562	822	123	333	333	563	563	563	104	154	184	1.5kV <sup>†</sup>
	332	392	682	223	223	393	473	473	683	104	124	2kV <sup>†</sup>
	152	182	332	103	103	223	273	273	393	563	683	3kV <sup>†</sup>
	821	102	182	682	682	123	153	153	223	273	393	4kV <sup>†</sup>
	561	821	122	392	392	822	103	103	123	183	223	5kV <sup>†</sup>

<sup>†</sup> Units rated above 800V may require conformal coating to preclude arcing over chip surface

# Commercial Chip - X7R 16Vdc to 10kVdc

A range of commercial MLC chip capacitors in Stable EIA Class II dielectric. Class II X7R chips are used as decoupling, by-pass, filtering and transient voltage suppression elements and exhibit +/-15% temperature coefficient and predictable variation of electrical properties with time, temperature and voltage.

Designed for surface mount application with nickel barrier terminations making them suitable for solder wave and reflow solder board attachment as well as vapor phase attachment for part sizes 2225 or smaller. Silver-palladium terminations are also available for hybrid use with conductive epoxy.

Standard EIA case sizes and available C/V values are listed below - special sizes, thicknesses and other voltage ratings are available; please contact the sales office for information.

## Capacitance and voltage selection for popular chip sizes

Size	0402	0504	0603	0805	1005	1206	1210	1515	1808	1812	1825			
Min cap.	121	121	121	121	121	121	121	151	151	151	151	471	471	
Tmax inches: mm:	0.024 0.61	0.044 1.12	0.035 0.89	0.054 1.37	0.054 1.37	0.064 1.63	0.065 1.63	0.130 3.02	0.065 1.63	0.080* 2.03	0.065 1.63	0.100* 2.54	0.080 2.03	0.140* 3.56
16V	562	393	273	124	154	334	474	125	684	824	125	155	185	225
25V	472	333	223	104	124	274	474	105	564	564	105	125	155	225
50V	472	333	223	104	124	274	474	824	394	564	824	125	155	225
100V	472	333	223	683	823	184	334	684	274	394	564	824	125	185
200V	222	153	103	333	473	104	184	564	184	224	334	564	824	155
250V	152	103	682	273	393	683	124	394	124	154	224	394	684	125
300V	•	•	•	153	183	473	823	274	823	104	154	224	474	824
400V	•	•	•	123	123	273	563	224	563	823	104	184	334	564
500V	•	•	•	123	822	223	563	154	563	683	104	154	334	474
600V	•	•	•	822	822	183	393	124	393	563	683	124	224	394
800V†	•	•	•	472	472	103	273	823	273	333	473	683	124	274
1kV†	•	•	•	272	272	682	153	563	153	223	273	473	823	154
1.5kV†	•	•	•	•	•	222	472	183	472	682	822	153	273	563
2kV†	•	•	•	•	•	102	222	822	272	332	472	682	123	273
3kV†	•	•	•	•	•	•	•	152	561	821	122	222	272	472
4kV†	•	•	•	•	•	•	•	122	331	391	681	122	152	272
5kV†	•	•	•	•	•	•	•	•	•	•	•	•	821	182
6kV†	•	•	•	•	•	•	•	•	•	•	•	•	•	•
7kV†	•	•	•	•	•	•	•	•	•	•	•	•	•	•
8kV†	•	•	•	•	•	•	•	•	•	•	•	•	•	•
9kV†	•	•	•	•	•	•	•	•	•	•	•	•	•	•
10kV†	•	•	•	•	•	•	•	•	•	•	•	•	•	•

† Units rated above 800V may require conformal coating to preclude arcing over chip surface

# Commercial Chip - X7R 16Vdc to 10kVdc

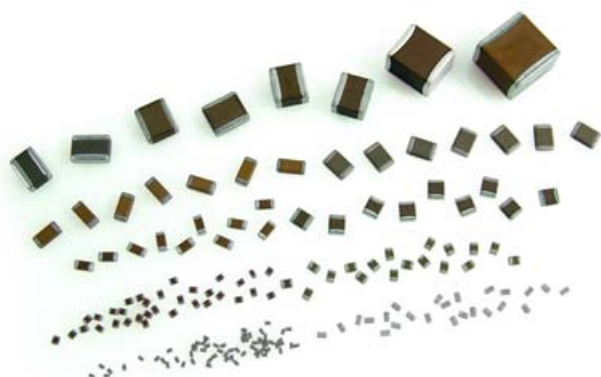

- For dielectric characteristics see page 6.
- For dimensions see page 12.
- For termination options see pages 3 & 15.
- For capacitance tolerances available see page 15.
- For ordering information see page 15.

**Note:** Maximum capacitance values are shown below as 3 digit code: 2 significant figures followed by the no. of zeros e.g. 183 = 18,000pF.

## Capacitance and voltage selection for popular chip sizes

	2020	2221	2225		2520	3333	3530	4040	4540	5440	5550	6560	7565	Size	
	471	471	471	471	102	102	102	102	102	102	102	222	222	Min cap.	
	0.180 4.57	0.080 2.03	0.080 2.03	0.150* 3.81	0.180 4.57	0.250 6.35	0.250 6.35	0.300 7.62	0.300 7.62	0.300 7.62	0.300 7.62	0.300 7.62	0.300 7.62	inches mm	Tmax
	185	155	225	275	355	525	525	825	905	106	126	206	256	16V	
	155	125	185	225	325	505	505	755	805	106	106	186	226	25V	
	155	125	185	225	325	425	425	705	755	905	106	156	206	50V	
	155	125	155	225	275	405	405	625	685	825	905	126	186	100V	
	125	684	105	185	225	355	355	565	625	705	825	825	156	200V	
	105	564	824	155	185	325	325	505	605	685	805	825	126	250V	
	824	394	474	105	125	225	225	475	505	575	705	755	106	300V	
	564	274	394	684	824	125	125	255	275	305	375	545	875	400V	
	474	274	334	564	684	105	105	185	185	185	225	335	475	500V	
	274	224	274	474	394	684	684	155	155	155	225	275	395	600V	
	224	124	154	334	274	474	394	684	824	105	155	225	275	800V <sup>†</sup>	
	154	823	104	224	184	334	334	564	684	684	105	155	185	1kV <sup>†</sup>	
	393	273	333	683	563	124	124	274	334	344	474	684	824	1.5kV <sup>†</sup>	
	273	123	153	333	273	823	683	154	184	184	274	394	474	2kV <sup>†</sup>	
	472	272	332	682	822	333	273	473	563	683	823	124	184	3kV <sup>†</sup>	
	272	152	152	332	472	183	153	223	333	393	473	823	104	4kV <sup>†</sup>	
	152	821	102	222	272	123	103	123	183	223	333	473	563	5kV <sup>†</sup>	
	•	•	•	•	•	682	562	822	123	153	223	333	393	6kV <sup>†</sup>	
	•	•	•	•	•	472	472	562	822	103	153	223	273	7kV <sup>†</sup>	
	•	•	•	•	•	•	332	472	682	822	123	153	223	8kV <sup>†</sup>	
	•	•	•	•	•	•	272	332	472	562	103	123	183	9kV <sup>†</sup>	
	•	•	•	•	•	•	182	272	392	472	682	103	123	10kV <sup>†</sup>	



\* Denotes non standard chip thickness.  
Order code needs to have an 'X' inserted together with the dimension in inches e.g. X080 where dimension is 0.080"

# Commercial Chip - BX

Manufactured with layer thickness, and minimal voltage coefficient, to meet BX requirements. BX characteristics are identical to X7R dielectric with the added restriction that the Temperature-Voltage Coefficient (TVC) does not exceed -25% DC at rated voltage, over -55°C to 125°C operating temperature.

High Reliability Testing available: HB = MIL-PRF-55681 Group A.  
HK = MIL-PRF-38534 Class K. HS = MIL-PRF-123 Group A

- For dielectric characteristics see page 6.
- For dimensions see page 12.
- For termination options see pages 3 & 15.
- For capacitance tolerances available see page 15.
- For ordering information see page 15.

**Note:** Maximum capacitance values are shown below as 3 digit code: 2 significant figures followed by the no. of zeros e.g. 183 = 18,000pF.

## BX - Capacitance and Voltage Selection

Size	0402	0504	0603	0805	1005	1206	1210	1808	1812	1825	2221	2225
Min cap.	121	121	121	121	121	121	121	151	151	471	471	471
16V	562	393	273	104	124	274	474	564	105	185	155	225
25V	472	333	223	104	124	274	474	564	105	155	125	185
50V	182	183	123	473	683	124	274	274	564	125	125	155
100V	681	682	472	183	183	473	104	104	184	394	334	474
200V	221	182	122	562	822	153	273	333	563	104	823	124
250V	•	681	391	182	272	472	103	103	223	563	473	683
300V	•	•	•	122	122	332	562	682	123	393	333	473
400V	•	•	•	681	681	182	332	392	562	183	183	223
500V	•	•	•	391	471	102	222	222	392	123	103	153

# Commercial Chip - Z5U & Y5V

General purpose Class III dielectrics, very stable with time, exhibiting +22% to -56% (Z5U) and +22% -82% (Y5V) temperature coefficients with very high capacitance density - typically aging less than 4% per decade.

They find application in by-pass and decoupling functions along with other applications where capacitance change over the operating temperature range is not critical. FlexiCap™ is the preferred termination to reduce the chance of mechanical cracking due to board flexure.

## Z5U/Y5V - Capacitance and Voltage Selection

Size	0402	0504	0603	0805	1005	1206	1210	1808	1812	1825	2221	2225
Min cap.	121	121	121	471	681	681	681	222	332	103	103	103
16V	563	474	334	125	185	225	475	565	106	226	186	226
25V	473	394	224	105	155	225	395	395	685	186	156	226
50V	333	224	154	684	105	185	335	335	565	156	126	186
100V	103	823	563	224	334	474	105	105	185	395	395	475
200V	682	223	153	563	823	154	334	334	564	155	155	185
250V	222	183	123	473	683	104	224	224	394	105	105	125



# Commercial Chip - RF Series BX & X7R



A range of commercial MLC chip capacitors with improved ESR performance. This series has been designed for rugged environments in high power broadband coupling and switching power supplies. The Class II ceramic dielectric (BX or X7R dependant on chip size) affords high volumetric efficiency with negligible piezoelectric effects.

Please consult the Sales Office if your specific requirement exceeds our catalog maximums (size, capacitance value, and voltage).

- For dielectric characteristics see page 6.
- For dimensions see page 12.
- Termination options:
  - P = Palladium/Silver
  - N = Nickel barrier 100% Tin (RoHS)
  - Y = Nickel barrier 90% Tin/10% Lead
  - B = Copper barrier 100% Tin (RoHS)
  - E = Copper barrier 90% Tin/10% Lead
- Capacitance tolerances available  $\pm 10\%$ ,  $\pm 20\%$
- For ordering information see page 15.

**Note:** Maximum capacitance values are shown below as 3 digit code: 2 significant figures followed by the no. of zeros e.g. 183 = 18,000pF.

## RF Series BX & X7R Capacitance and Voltage Selection

Size	0505	1111	2525				
Tmax inches - mm:	0.057 - 1.45*	0.102 - 2.59*	0.165 - 4.19*				
Dielectric	BX	BX	X7R				
Rated Voltage	50	50	100	150	200	250	300
471	•						
561	•						
681	•						
821	•						
102	•						
122	•						
152	•						
182	•						
222	•						
272	•						
332	•						
392	•						
472	•	•					
502	•	•					
562	•	•					
682	•	•					
822	•	•					
103	•	•					•
123		•					•
153		•					•
183		•					•
223		•					•
273		•					
333		•				•	
393		•				•	
473		•				•	
503		•					
563		•					
683		•				•	
823		•			•		
104		•			•		
124					•		
154					•		
224					•		
334				•			
474				•			
564				•			
684				•			
824			•				
105			•				

\* Denotes non standard chip thickness. Order code needs to have an 'X' inserted together with the dimension in inches e.g. X057 where dimension is 0.057"

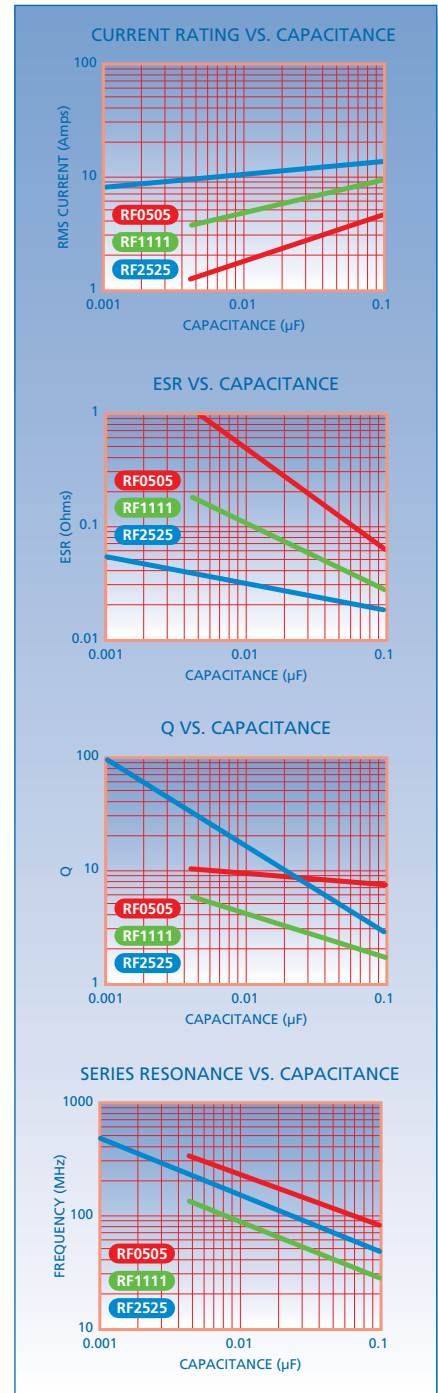

# Commercial Radial Lead 50V to 5kV

RoHS compliant interconnects, small case size, Radial Leaded Capacitors available in COG, X7R and X8R dielectrics. The conformal coating and lead mounting style provide a rugged configuration for optimum performance. Units exhibit high capacitance efficiency per KV rating and find application in commercial/industrial use up to 5kV, such as power supplies and voltage multiplier circuits. They are offered in bulk pack or taped form, Ref EIA-RS468, making them suitable for automatic insertion.

For dielectric characteristics see pages 4 & 6.

For capacitance tolerances available see page 26.

For ordering information see page 26.

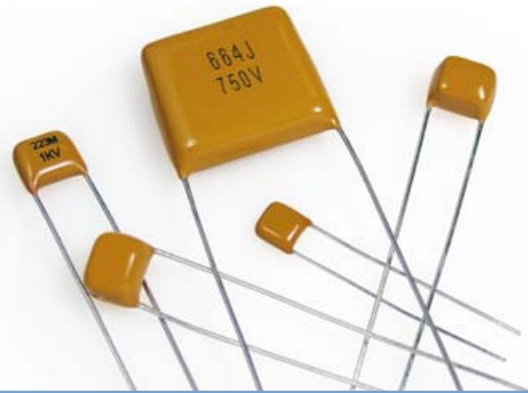

## Dimensions - inches/mm

Lead Style	LE	LD	LR	LD	LQ	LD	LE	LB
Size	0805	0805	1206	1206	1206	1210	1812	2225
Wmax inches: mm:	0.150 3.81	0.150 3.81	0.200 5.08	0.200 5.08	0.200 5.08	0.200 5.08	0.300 7.62	0.350 8.89
Hmax inches: mm:	0.150 3.81	0.150 3.81	0.150 3.81	0.150 3.81	0.150 3.81	0.200 5.08	0.250 6.35	0.350 8.89
Tmax inches: mm:	0.100 2.54	0.100 2.54	0.125 3.18	0.125 3.18	0.125 3.18	0.175 4.45	0.200 5.08	0.200 5.08
HSmax inches: mm:	0.200 5.08	0.250 6.35	0.250 6.35	0.250 6.35	0.250 6.35	0.300 7.62	0.350 8.89	0.500 12.70
S inches $\pm 0.02$ : mm $\pm 0.51$ :	0.100 2.54	0.200 5.08	0.100 2.54	0.200 5.08	0.250 6.35	0.200 5.08	0.200 5.08	0.200 5.08
WD inches $\pm 0.02$ : mm $\pm 0.51$ :	0.020 0.51	0.020 0.51	0.020 0.51	0.020 0.51	0.020 0.51	0.020 0.51	0.025 0.64	0.025 0.64

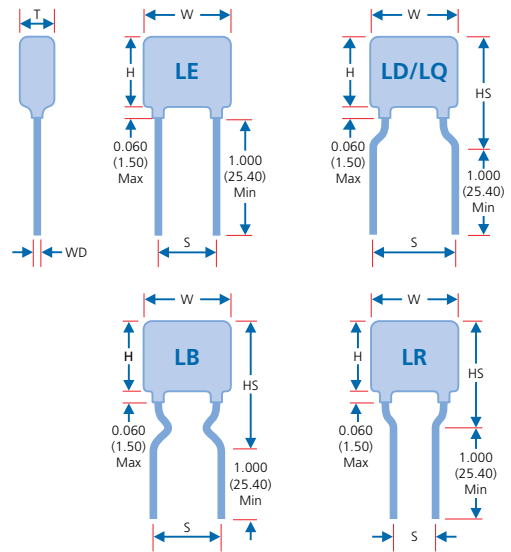

## Capacitance and Voltage Selection

Size	0805			1206			1210			1812			2225		
Min cap.	100	121	121	100	121	221	100	121	331	101	151	221	101	471	102
	COG	X7R	X8R	COG	X7R	X8R	COG	X7R	X8R	COG	X7R	X8R	COG	X7R	X8R
50V	392	104	473	123	274	154	223	474	274	393	125	564	124	185	125
100V	392	683	333	103	184	104	183	334	184	273	824	394	823	155	105
250V	152	273	183	392	683	333	822	124	823	223	394	154	473	824	564
500V	821	123	562	182	223	153	472	563	393	123	154	563	273	334	154
1kV	471	272	•	102	682	•	222	153	•	822	473	•	153	104	•
2kV	•	•	•	391	102	•	821	222	•	272	682	•	392	153	•
3kV	•	•	•	•	•	•	•	•	•	122	272	•	182	562	•
4kV	•	•	•	•	•	•	•	•	•	821	122	•	102	152	•
5kV	•	•	•	•	•	•	•	•	•	•	•	•	561	102	•

**Note:** Maximum capacitance values are shown above as 3 digit code: 2 significant figures followed by the no. of zeros e.g. 183 = 18,000pF. R denotes decimal e.g. 2R7 = 2.7pF.

# Commercial Radial Lead 500V to 10kV

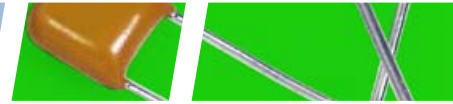

RoHS or Non RoHS Radial Leaded Capacitors available in COG and X7R dielectrics with high voltage ratings from 500V. The conformal coating and lead mounting style provide a rugged configuration for optimum performance. Units exhibit high capacitance efficiency per KV rating and find application in commercial/industrial use up to 10kV, such as power supplies and voltage multiplier circuits. They are also offered without the conformal coating for less harsh environmental applications.

- For dielectric characteristics see pages 4 & 6.
- For capacitance tolerances available see page 26.
- For ordering information see page 26.

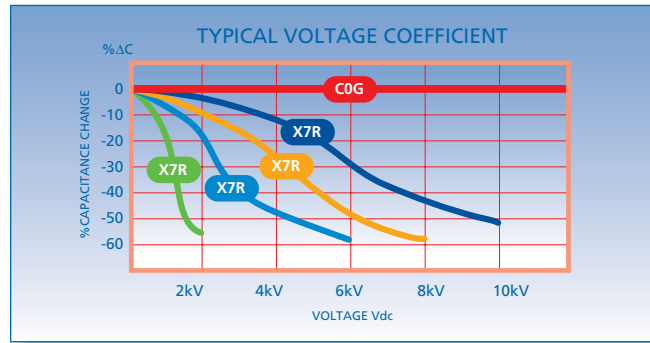

## Dimensions - inches/mm

Lead Style	LE with conformal coating - LO without							
	Size	1515	2520	3530	4540	5550	6560	7565
<b>Wmax</b>	inches: mm:	0.250 6.35	0.400 10.20	0.500 12.70	0.600 15.20	0.700 17.80	0.800 20.30	0.900 22.80
<b>Hmax</b>	inches: mm:	0.250 6.35	0.350 8.89	0.450 11.40	0.550 14.00	0.650 16.50	0.750 19.00	0.850 21.60
<b>Tmax</b>	inches: mm:	0.200 5.08	0.250 6.35	0.350 8.89	0.400 10.20	0.400 10.20	0.400 10.20	0.400 10.20
<b>S</b>	inches ±0.02: mm ±0.51:	0.170 4.32	0.280 7.10	0.380 9.65	0.480 12.20	0.580 14.70	0.680 17.30	0.780 19.80

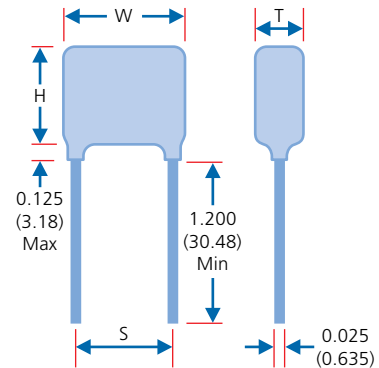

## Capacitance and Voltage Selection

Size	1515		2520		3530		4540		5550		6560		7565	
<b>Min cap.</b>	100	151	390	102	390	102	390	102	390	102	560	222	101	222
	COG	X7R	COG	X7R	COG	X7R	COG	X7R	COG	X7R	COG	X7R	COG	X7R
<b>500V</b>	822	154	393	684	683	105	124	185	184	225	274	335	334	475
<b>600V</b>	682	124	223	394	393	684	823	155	154	225	224	275	274	395
<b>800V</b>	682	823	183	274	333	394	683	824	124	155	184	225	224	275
<b>1kV</b>	562	563	123	184	273	334	563	684	104	105	154	155	184	225
<b>2kV</b>	272	822	562	273	153	683	333	184	473	274	683	394	104	474
<b>3kV</b>	122	332	272	123	103	273	223	683	333	124	473	184	563	224
<b>4kV</b>	681	122	152	472	562	153	123	333	183	473	273	823	393	104
<b>5kV</b>	•	•	102	272	332	103	822	183	123	333	183	473	223	563
<b>6kV</b>	•	•	•	•	182	562	392	123	562	223	103	333	123	393
<b>7kV</b>	•	•	•	•	122	472	272	822	472	153	682	223	822	273
<b>8kV</b>	•	•	•	•	102	332	222	682	332	123	562	153	682	223
<b>9kV</b>	•	•	•	•	•	272	182	472	272	103	392	123	472	183
<b>10kV</b>	•	•	•	•	•	182	152	392	222	682	332	103	392	123

**Note:** Maximum capacitance values are shown above as 3 digit code: 2 significant figures followed by the no. of zeros: e.g. 183 = 18,000pF.

# Radial Ordering Information

## How to Order - Radial Lead - Commercial & High Rel

0805	B	123	K	501	LE	H	A	R
<b>SIZE</b> See charts	<b>DIELECTRIC</b> N = COG B = X7R RN = COG RoHS 2013 ≤ 200V RB = X7R RoHS 2013 ≤ 200V S = X8R not RoHS compliant	<b>CAPACITANCE</b> Value in Picofarads. Two significant figures, followed by number of zeros: 123 = 12,000pF	<b>TOLERANCE</b> F = ±1%* G = ±2%* J = ± 5% K = ± 10% M = ± 20%	<b>VOLTAGE-VDCW</b> Two significant figures, followed by number of zeros: 501 = 500V	<b>LEAD STYLES</b> LE, LB, LD, LR, LQ* = Yellow conformal coated LO = without any coating	<b>HIGH RELIABILITY</b> Specify testing - see page 27	<b>PACKING</b> No suffix = Bulk A = Ammo pack 2K/pack T = Tape & Reel 4K/Reel	<b>RoHS</b> R = RoHS Compliant
			*COG parts only		* Product & Case size dependant			

## How to Order - Radial Lead - High Temperature

2520	E	563	K	501	LG	H	W	R
<b>SIZE</b> See charts	<b>DIELECTRIC</b> D = 200°C COG E = 200°C Class II	<b>CAPACITANCE</b> Value in Picofarads. Two significant figures, followed by number of zeros: 563 = 56,000pF	<b>TOLERANCE</b> F = ±1%* G = ±2%* J = ± 5% K = ± 10% M = ± 20%	<b>VOLTAGE-VDCW</b> Two significant figures, followed by number of zeros: 501 = 500V	<b>LEAD STYLES</b> LC = Encapsulated LG = Black Epoxy Coated LO = without any coating	<b>HIGH TEMP SCREENING</b> Novacap High Temperature screening procedure	<b>PACKING</b> No suffix = Bulk W = Waffle pack	<b>RoHS</b> R = RoHS Compliant Only available on ≥250V
			*COG parts only					



# High Reliability Testing



Our High Rel products are designed for optimum reliability and are burned in at elevated voltage and temperature levels. They are 100% electrically inspected to ascertain conformance to a strict performance criteria.

Applications for High Reliability products include medical implanted devices, aerospace, airborne, various military applications, and consumer uses requiring safety margins not attainable with conventional product.

We have the ability to test surface mount and leaded capacitors to High Reliability standards as detailed below, or to customer SCD.

Military performance specifications are designed and written for the voltage/capacitance ratings of the individual product slash numbers associated with the specification.

Some of the requirements of the military document may not apply to the NOVACAP High Reliability product. The following details the intent of the individual military specifications available for test and the deviations that may apply.

Product voltage ratings outside of the intended military specification will follow the NOVACAP voltage test potential outlined.

Contact the sales office with any requirements or deviations that are not covered here.

## Environmental Testing

We also have the capability to perform all the Environmental Group B, Group C, and Qualification testing to the referenced military specifications.

Testing abilities include the following:

- Nondestructive internal examination
- Destructive physical analysis
- Radiographic inspection
- Terminal strength
- Resistance to soldering heat
- Voltage-temperature limits
- Temperature coefficient
- Moisture resistance
- Humidity, steady state, low voltage
- Vibration
- Resistance to solvents
- Life
- Thermal shock and immersion
- Low temperature storage
- Barometric pressure
- Shock, specified pulse
- Mechanical shock
- Constant acceleration
- Wire bond evaluation
- Partial discharge (corona)
- 200°C Voltage Conditioning

## Military Performance Specifications

### MIL-PRF-55681 (GROUP A)

General purpose military high reliability specification for surface mount sizes 0805 through 2225 in 50V and 100V.

- VOLTAGE CONDITIONING
- 100 HRS, 2X VDCW, 125°C
- DWV, IR, 125°C IR, CAP, DF TEST
- VISUAL & MECH. INSPECTION (AQL SAMPLE PLAN)
- SOLDERABILITY, SAMPLE 13(0)
- 8% PDA MAXIMUM

### MIL-PRF-123 (GROUP A)

The specification affords an increased reliability level over MIL-PRF-55681 for space, missile and other high reliability applications such as medical implantable or life support equipment. The specification covers surface mount sizes 0805 through 2225 in 50V rating and various radial / axial leaded products in 50V, 100V, and 200V ratings.

- THERMAL SHOCK, 20 CYCLES
- VOLTAGE CONDITIONING 168/264 HRS, 2X VDCW, 125°C
- DWV, IR, 125°C IR, CAP, DF TEST
- VISUAL & MECH. INSPECTION SAMPLE 20(0)
- DPA<sup>(1)</sup>
- PDA, 3% (0.1%), 5% (0.2%) MAX<sup>(2)</sup>

### MIL-PRF-39014 (GROUP A)

The specification covers general military purpose radial / axial leaded and encapsulated product in 50V, 100V, and 200V ratings.

- THERMAL SHOCK, 5 CYCLES
- VOLTAGE CONDITIONING 96 HRS, 2X VDCW, 125°C
- DWV, IR, 125°C IR, CAP, DF TEST
- VISUAL & MECH. INSPECTION (AQL SAMPLE PLAN)
- SOLDERABILITY, SAMPLE 13(0)
- 8% PDA MAXIMUM

### MIL-PRF-49467 (GROUP A)

General purpose military high reliability specification for radial leaded epoxy coated. The specification covers sizes 1515 through 13060 with 600V, 1000V, 2000V, 3000V, 4000V, and 5000V ratings.

- THERMAL SHOCK, 5 CYCLES
- VOLTAGE CONDITIONING 96 HRS, RATED VDCW, 125°C
- PARTIAL DISCHARGE (OPTION) <sup>(3)</sup>
- DWV, IR, 125°C IR, CAP, DF TEST
- VISUAL & MECH. INSPECTION SAMPLE 13(0)
- SOLDERABILITY, SAMPLE 5(0)
- 10% PDA MAXIMUM

### MIL-PRF-49470 (DSCC 87106) (GROUP A)

General purpose military high reliability specification for stacked and leaded capacitors for switch mode power supplies. The specification covers sizes 2225 through 120200 in 50V, 100V, 200V and 500V ratings.

- THERMAL SHOCK, 5 CYCLES
- VOLTAGE CONDITIONING 96 HRS, 2X VDCW<sup>(4)</sup>, 125°C
- DWV, IR, 125°C IR, CAP, DF TEST
- VISUAL & MECH. INSPECTION SAMPLE 13(0)
- SOLDERABILITY, SAMPLE 5(0)
- 10% PDA MAXIMUM

### MIL-PRF-38534

Specification for Hybrid Microcircuits with a section for Element Evaluation on passive components.

There are two classification levels of reliability. Class H is for a standard military quality level. Class K is for the highest reliability level intended for space application.

Novacap will perform a 100-hour burn-in on all Class K products. Novacap assumes Class K Subgroup 3 samples will be unmounted and Subgroup 4 (wirebond) shall not apply unless otherwise stated.

### NOVACAP TEST VOLTAGE (VDC)

This test potential shall be used on all High Reliability Testing unless otherwise specified.

	WVDC	DWV	V/C*
<200		2.5X Rated	2.0X Rated
250		500V	400V
300		500V	400V
400		600V	500V
500		750V	600V
600		750V	600V
*V/C Is Voltage Conditioning.	>700	1.2X Rated	1.0X Rated

- (1) MIL-PRF-123 DPA shall be per TABLE XIV AQL requirements unless otherwise specified.
- (2) MIL-PRF-123 allowable PDA shall be 3% overall and 0.1% in the last 48 hours for capacitance/voltage values listed in MIL-PRF-123, and be 5% overall and 0.2% in the last 48 hours for capacitance/voltage values beyond MIL-PRF-123.
- (3) MIL-PRF-49467 standard Group A is without Partial Discharge. Partial Discharge test is optional and must be specified.
- (4) MIL-PRF-49470 (DSCC 87106) 500V rated product has Voltage Conditioning at 1.2X VDCW.

# High Reliability Chip - COG 16Vdc to 10kVdc

A range of MLC chip capacitors in Ultra stable EIA Class I COG, or NPO, dielectric with special testing for long term reliability. They are designed for optimum reliability; burned in at elevated voltage and temperature, and 100% physically and electrically inspected to ascertain conformance to strict performance criteria. Units may be tested in accordance with MIL-PRF-55681, MIL-PRF-123, MIL-PRF-49467, or customer SCD.

Designed for surface mount application with nickel barrier terminations making them suitable for solder wave and reflow solder board attachment as well as vapor phase attachment for part sizes 2225 or smaller. Silver-palladium terminations are also available for hybrid use with conductive epoxy.

COG chips are used in precision circuitry requiring Class I stability and exhibit linear temperature coefficient, low loss and stable electrical properties with time, voltage & frequency.

They find application for High Reliability use such as medical implanted devices, aerospace, airborne and military use as well as consumer uses requiring safety margins not attainable with commercial products.

Standard EIA case sizes and available C/V values are listed below - special sizes, thicknesses and other voltage ratings are available; please contact the sales office for information.

## Capacitance and voltage selection for popular chip sizes

Size	0402	0504	0603	0805	1206	1206	1210	1515	1808	1812	1825			
Min cap.	0R3	0R5	0R3	0R5	0R5	3R0	5R0	3R0	5R0	5R0	100	100	150	150
Tmax inches: mm:	0.024 0.61	0.044 1.12	0.035 0.89	0.054 1.37	0.054 1.37	0.064 1.63	0.065 1.63	0.130 3.02	0.065 1.63	0.080* 2.03	0.065 1.63	0.100* 2.54	0.080 2.03	0.140* 3.56
16V	81	152	102	392	562	103	223	393	223	273	473	473	104	104
25V	181	152	102	392	562	123	223	393	223	273	473	473	104	104
50V	181	152	102	392	562	123	223	333	183	223	393	393	104	104
100V	101	821	561	222	332	682	123	273	123	183	273	273	683	823
200V	101	561	331	152	222	392	822	223	822	103	153	273	473	683
250V	390	391	271	102	152	272	562	183	562	682	123	183	273	473
300V	•	•	•	681	681	182	392	123	392	472	822	123	223	273
400V	•	•	•	681	561	152	392	822	392	472	822	103	183	183
500V	•	•	•	681	561	152	392	682	392	392	822	103	183	183
600V	•	•	•	•	•	122	392	682	392	392	822	103	183	183
800V†	•	•	•	•	•	102	222	472	222	222	472	682	123	153
1kV†	•	•	•	•	•	681	152	392	152	152	332	562	822	123
1.5kV†	•	•	•	•	•	271	681	222	681	102	152	222	392	682
2kV†	•	•	•	•	•	151	391	122	391	391	821	122	222	392
3kV†	•	•	•	•	•	•	•	561	181	181	391	561	102	182
4kV†	•	•	•	•	•	•	•	•	•	•	•	•	391	681
5kV†	•	•	•	•	•	•	•	•	•	•	•	•	221	471
6kV†	•	•	•	•	•	•	•	•	•	•	•	•	•	•
7kV†	•	•	•	•	•	•	•	•	•	•	•	•	•	•
8kV†	•	•	•	•	•	•	•	•	•	•	•	•	•	•
9kV†	•	•	•	•	•	•	•	•	•	•	•	•	•	•
10kV†	•	•	•	•	•	•	•	•	•	•	•	•	•	•

† Units rated above 800V may require conformal coating to preclude arcing over chip surface  
Maximum voltage for MIL-PRF-123 tested parts is 1kV

# High Reliability Chip - C0G 16Vdc to 10kVdc



- For dielectric characteristics see page 4.
- For dimensions see page 12.
- For termination options see pages 3 & 15.
- For capacitance tolerances available see page 15.
- For ordering information see page 15.

**Note:** Maximum capacitance values are shown below as 3 digit code: 2 significant figures followed by the no. of zeros e.g. 183 = 18,000pF.

## Capacitance and voltage selection for popular chip sizes

	2020	2221	2225		2520	3333	3530	4040	4540	5440	5550	6560	7565	Size
	270	270	270	270	390	390	390	390	390	390	390	560	101	Min cap.
	0.180 4.57	0.080 2.03	0.080 2.03	0.150* 3.81	0.180 4.57	0.250 6.35	0.250 6.35	0.300 7.62	0.300 7.62	0.300 7.62	0.300 7.62	0.300 7.62	0.300 7.62	inches Tmax mm
	683	104	124	124	104	184	184	334	334	334	394	684	824	16V
	683	104	124	124	104	184	184	334	334	334	394	684	824	25V
	683	104	124	124	104	154	184	274	334	274	394	564	824	50V
	563	683	823	104	823	124	154	224	274	224	274	474	564	100V
	473	393	473	823	683	104	104	184	184	184	224	394	474	200V
	393	223	273	563	563	823	104	154	184	184	224	394	474	250V
	333	183	273	473	473	823	823	154	154	154	184	334	394	300V
	223	183	273	273	333	563	563	124	124	124	154	274	334	400V
	153	183	273	273	183	473	473	823	104	104	124	224	274	500V
	153	183	273	273	183	393	393	683	823	823	124	184	274	600V
	103	103	153	223	123	333	333	563	683	683	104	154	184	800V <sup>†</sup>
	103	822	123	183	123	273	273	473	563	563	823	124	184	1kV <sup>†</sup>
	682	392	562	103	822	183	183	333	393	393	563	823	124	1.5kV <sup>†</sup>
	392	182	272	562	472	153	153	223	273	333	473	683	823	2kV <sup>†</sup>
	182	821	122	272	222	682	682	153	183	183	273	393	473	3kV <sup>†</sup>
	681	331	471	102	102	272	272	562	682	822	103	153	223	4kV <sup>†</sup>
	391	221	331	681	561	182	182	392	472	472	682	103	123	5kV <sup>†</sup>
	•	•	•	•	•	152	152	272	332	332	472	822	822	6kV <sup>†</sup>
	•	•	•	•	•	•	821	152	182	182	272	392	472	7kV <sup>†</sup>
	•	•	•	•	•	•	•	102	122	122	182	272	392	8kV <sup>†</sup>
	•	•	•	•	•	•	•	•	821	102	122	222	272	9kV <sup>†</sup>
	•	•	•	•	•	•	•	•	681	821	122	182	222	10kV <sup>†</sup>

\* Denotes non standard chip thickness.

Order code needs to have an 'X' inserted together with the dimension in inches e.g. X080 where dimension is 0.080"

# High Reliability Chip - X7R 16Vdc to 10kVdc

A range of MLC chip capacitors in Stable EIA Class II dielectric with special testing for long term reliability. They are designed for optimum reliability; burned in at elevated voltage and temperature, and 100% physically and electrically inspected to ascertain conformance to strict performance criteria. Units may be tested in accordance with MIL-PRF-55681, MIL-PRF-123, MIL-PRF-49467, or customer SCD.

Designed for surface mount application with nickel barrier terminations making them suitable for solder wave and reflow solder board attachment as well as vapor phase attachment for part sizes 2225 or smaller. Silver-palladium terminations are also available for hybrid use with conductive epoxy.

Class II X7R chips are used as decoupling, by-pass, filtering and transient voltage suppression elements and exhibit +/-15% temperature coefficient and predictable variation of electrical properties with time, temperature and voltage.

They find application for High Reliability use such as medical implanted devices, aerospace, airborne and military use as well as consumer uses requiring safety margins not attainable with commercial products.

Standard EIA case sizes and available C/V values are listed below - special sizes, thicknesses and other voltage ratings are available; please contact the sales office for information.

## Capacitance and voltage selection for popular chip sizes

Size	0402	0504	0603	0805	1005	1206	1210	1515	1808	1812	1825			
Min cap.	121	121	121	121	121	121	121	151	151	151	151	471	471	
Tmax inches: mm:	0.024 0.61	0.044 1.12	0.035 0.89	0.054 1.37	0.054 1.37	0.064 1.63	0.065 1.63	0.130 3.02	0.065 1.63	0.080* 2.03	0.065 1.63	0.100* 2.54	0.080 2.03	0.140* 3.56
16V	472	333	223	104	124	274	474	105	394	684	824	824	155	225
25V	472	333	223	104	124	274	474	824	394	564	824	824	155	225
50V	472	333	223	823	104	224	394	824	334	474	684	684	125	185
100V	392	273	183	563	683	154	274	684	224	334	474	474	105	185
200V	182	123	822	223	333	823	124	394	124	154	224	394	564	105
250V	102	822	562	183	273	393	823	224	683	104	124	124	394	684
300V	•	•	•	103	123	273	563	184	563	683	104	154	274	474
400V	•	•	•	682	682	183	333	104	333	393	563	124	184	334
500V	•	•	•	472	472	123	273	823	273	333	473	683	124	274
600V	•	•	•	332	272	682	153	563	183	223	273	473	823	184
800V†	•	•	•	222	182	472	103	333	103	123	183	273	563	104
1kV†	•	•	•	122	821	222	562	183	562	822	103	183	333	563
1.5kV†	•	•	•	•	•	102	222	822	272	332	392	822	123	273
2kV†	•	•	•	•	•	471	102	392	122	152	182	332	682	123
3kV†	•	•	•	•	•	•	•	102	391	471	821	152	152	332
4kV†	•	•	•	•	•	•	•	•	181	271	391	681	821	182
5kV†	•	•	•	•	•	•	•	•	•	•	•	•	561	102
6kV†	•	•	•	•	•	•	•	•	•	•	•	•	•	•
7kV†	•	•	•	•	•	•	•	•	•	•	•	•	•	•
8kV†	•	•	•	•	•	•	•	•	•	•	•	•	•	•
9kV†	•	•	•	•	•	•	•	•	•	•	•	•	•	•
10kV†	•	•	•	•	•	•	•	•	•	•	•	•	•	•

† Units rated above 800V may require conformal coating to preclude arcing over chip surface. Maximum voltage for MIL-PRF-123 tested parts is 1kV.



# High Reliability Chip - X7R 16Vdc to 10kVdc

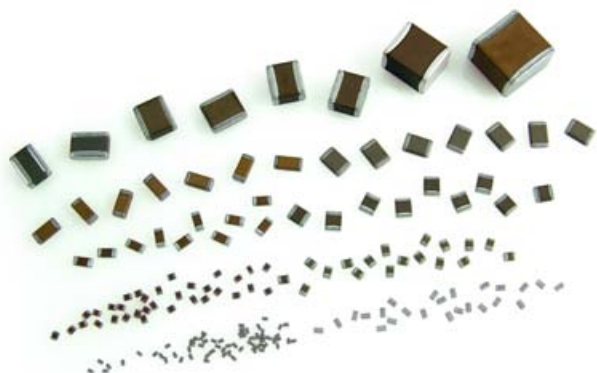

- For dielectric characteristics see page 6.
- For dimensions see page 12.
- For termination options see pages 3 & 15.
- For capacitance tolerances available see page 15.
- For ordering information see page 15.

**Note:** Maximum capacitance values are shown below as 3 digit code: 2 significant figures followed by the no. of zeros e.g. 183 = 18,000pF.

## Capacitance and voltage selection for popular chip sizes

	2020	2221	2225		2520	3333	3530	4040	4540	5440	5550	6560	7565	Size	
	102	471	471	471	102	102	102	102	102	102	102	222	222	Min cap.	
	0.180 4.57	0.080 2.03	0.080 2.03	0.150* 3.81	0.180 4.57	0.250 6.35	0.250 6.35	0.300 7.62	0.300 7.62	0.300 7.62	0.300 7.62	0.300 7.62	0.300 7.62	inches mm	Tmax
	185	125	185	275	225	475	475	825	825	106	126	186	226	16V	
	155	125	185	225	225	475	475	685	825	106	126	186	206	25V	
	155	125	155	225	155	395	395	685	685	825	106	156	186	50V	
	125	824	125	185	125	335	335	565	685	685	825	106	156	100V	
	105	474	564	125	125	275	275	475	475	565	685	825	106	200V	
	684	394	394	684	804	225	225	475	475	565	685	825	106	250V	
	564	224	334	684	684	185	185	335	335	395	475	685	825	300V	
	334	154	184	394	394	105	105	185	225	225	275	335	565	400V	
	224	154	154	334	274	684	684	125	155	155	185	275	395	500V	
	154	823	104	224	184	474	474	824	824	105	155	225	275	600V	
	104	563	683	124	124	334	334	564	684	824	125	185	225	800V <sup>†</sup>	
	563	273	393	823	683	184	184	394	474	474	684	105	125	1kV <sup>†</sup>	
	123	123	153	333	333	823	823	184	184	224	274	474	564	1.5kV <sup>†</sup>	
	123	562	822	153	153	473	473	104	104	124	184	224	334	2kV <sup>†</sup>	
	272	182	222	392	562	223	223	333	473	473	683	104	154	3kV <sup>†</sup>	
	182	821	102	222	272	123	123	183	223	273	393	563	823	4kV <sup>†</sup>	
	102	561	561	122	182	682	822	103	153	183	273	393	473	5kV <sup>†</sup>	
	•	•	•	•	•	472	562	682	103	123	183	273	333	6kV <sup>†</sup>	
	•	•	•	•	•	•	392	472	682	822	123	183	273	7kV <sup>†</sup>	
	•	•	•	•	•	•	272	392	562	682	103	153	183	8kV <sup>†</sup>	
	•	•	•	•	•	•	222	272	392	472	682	123	153	9kV <sup>†</sup>	
	•	•	•	•	•	•	152	222	332	392	562	822	123	10kV <sup>†</sup>	

\* Denotes non standard chip thickness.  
Order code needs to have an 'X' inserted together with the dimension in inches e.g. X080 where dimension is 0.080"

# High Reliability Radial Lead 500V to 10kV

Radial Leaded Capacitors available in COG and X7R characteristics with special testing for long term reliability. The conformal coating and lead mounting style provide a rugged configuration for optimum performance. Units may be tested to MIL-PRF-49467 and/ or MIL-PRF-39014 and find application for High Reliability use such as power supplies, voltage multiplier circuits, aerospace, airborne and military use for radar. They are also offered without the conformal coating for less harsh environmental applications, and as RoHS compliant parts upon request.

- For dielectric characteristics see pages 4 & 6.
- For capacitance tolerances available see page 15.
- For ordering information see page 26.

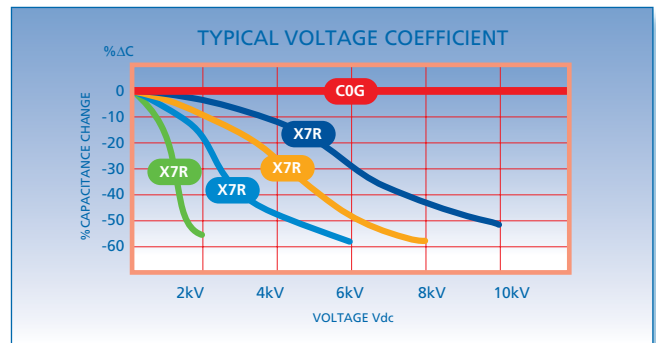

## Dimensions - inches/mm

Lead Style	LE with conformal coating - LO without coating							
	Size	1515	2520	3530	4540	5550	6560	7565
Wmax	inches: mm:	0.250 6.35	0.400 10.20	0.500 12.70	0.600 15.20	0.700 17.80	0.800 20.30	0.900 22.80
Hmax	inches: mm:	0.250 6.35	0.350 8.89	0.450 11.40	0.550 14.0	0.650 16.50	0.750 19.0	0.850 21.60
Tmax	inches: mm:	0.200 5.08	0.250 6.35	0.350 8.89	0.400 10.20	0.400 10.20	0.400 10.20	0.400 10.20
S	inches ±0.02: mm ±0.51:	0.170 4.32	0.280 7.10	0.380 9.65	0.480 12.20	0.580 14.70	0.680 17.30	0.780 19.80

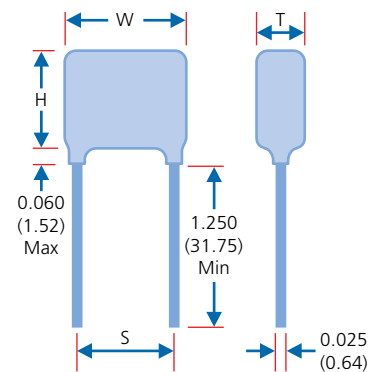

## Capacitance and Voltage Selection

Size	1515		2520		3530		4540		5550		6560		7565	
Min cap.	3R0	151	390	102	390	102	390	102	390	102	560	222	101	222
Dielectric	COG	X7R	COG	X7R	COG	X7R	COG	X7R	COG	X7R	COG	X7R	COG	X7R
500V	682	823	183	274	473	684	823	155	124	185	224	275	274	395
600V	682	563	183	184	393	474	823	824	124	155	184	225	274	275
800V	472	333	123	124	333	334	683	684	104	125	154	185	184	225
1kV	392	183	123	683	273	184	563	474	823	684	124	105	184	125
2kV	122	392	472	153	153	473	273	104	473	184	683	224	823	334
3kV	561	152	222	562	682	223	183	472	273	683	393	104	473	154
4kV	•	•	102	272	272	123	682	223	103	393	153	563	223	823
5kV	•	•	561	182	182	822	472	153	682	273	103	393	123	473
6kV	•	•	•	•	152	562	332	103	472	183	822	273	822	333
7kV	•	•	•	•	821	392	182	682	272	123	392	183	472	273
8kV	•	•	•	•	•	272	122	562	182	103	272	153	392	183
9kV	•	•	•	•	•	•	821	392	122	682	222	123	272	153
10kV	•	•	•	•	•	•	681	332	122	562	182	822	222	123

**Note:** Maximum capacitance values are shown above as 3 digit code: 2 significant figures followed by the no. of zeros e.g. 183 = 18,000pF. R denotes decimal e.g. 2R7 = 2.7pF.

# DSCC Approved Radial Lead



A range of High Voltage leaded capacitors available in ten DSCC approved specifications.

The below referenced DSCC (Defense Supply Center Columbus) drawing numbers cover the NPO and X7R dielectrics with a voltage rating from 1kV to 10kVDC.

Novacap Vendor CAGE code is 65238.

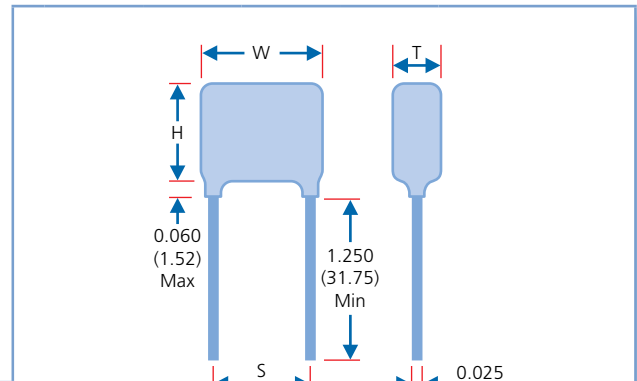

## Dimensions - inches/mm

Lead Style	LE with conformal coating											
	1515	2020	2520	3015	3530	4020	4540	5550	6560	9040	11050	13060
<b>Wmax</b> inches: mm:	0.250 6.35	0.320 8.13	0.370 9.40	0.450 11.43	0.470 11.94	0.550 13.97	0.570 14.48	0.670 17.02	0.770 19.56	1.050 26.67	1.250 31.75	1.450 36.83
<b>Hmax</b> inches: mm:	0.220 5.59	0.280 7.11	0.300 7.62	0.220 5.59	0.400 10.16	0.280 7.11	0.500 12.70	0.600 15.24	0.720 18.29	0.500 12.7	0.600 15.24	0.720 18.29
<b>Tmax</b> inches: mm:	0.200 5.08	0.250 6.35	0.250 6.35	0.270* 6.86	0.270 6.86	0.250 6.35	0.270 6.86	0.270 6.86	0.270 6.86	0.270 6.86	0.270 6.86	0.270 6.86
<b>S</b> ±0.03 inches: ±0.76 mm:	0.170 4.32	0.220 5.59	0.275 6.98	0.300 7.62	0.375 9.53	0.400 10.16	0.475 12.07	0.575 14.61	0.675 17.15	0.900 22.86	1.100 27.94	1.300 33.02

\*Maximum thickness for 87076 is 0.200/5.08

## Dash Numbers

DSCC#	Rated Voltage	1515	2020	2520	3015	3530	4020	4540	5550	6560	9040	11050	13060
87043	1kV	01-50	51-58	59-60	•	61-70	•	71-78	79-84	85-90	•	•	•
87046	1kV	01-50	51-56	57-58	•	59-66	•	67-74	75-80	81-84	•	•	•
87040	2kV	04-40	41-46	47-50	•	51-60	•	61-66	67-70	71-74	•	75-78	79-82
87047	3kV	•	01-38	39-42	•	43-54	•	55-62	63-64	65-68	•	69-70	71-75
87114	3kV	•	01-44	45-46	•	47-54	•	55-64	65-68	69-72	•	•	•
87076	4kV	•	•	•	01-24	25-50	•	51-58	59-62	63-64	•	•	65-70
89044	4kV	•	•	•	01-24	25-46	•	47-50	51-54	55-60	•	61-62	63-68
87070	5kV	•	•	•	•	•	01-24	25-46	47-50	51-54	55-58	59-60	61-62
87077	5kV	•	•	•	•	•	01-40	•	41-58	59-60	•	•	61-68
87081	10kV	•	•	•	•	•	•	•	•	•	01-22	23-26	27-34

## How to Order - The purchase order or contract must specify the following:

1	2	3
The Complete DSCC part number - Drawing Number <i>and</i> Dash Number Example: 87043-47	Whether you want Novacap to perform the Group B Test, or provide a certification of compliance for Group B requirement.	Specify requirements for packaging.

# DSCC Approved Capacitor Assemblies

A range of switch mode leaded capacitor assemblies in three approved DSCC 87106 case codes sizes.

The below referenced DSCC (Defense Supply Center Columbus) dash numbers show our approved range.

Novacap Vendor CAGE code is 65238.

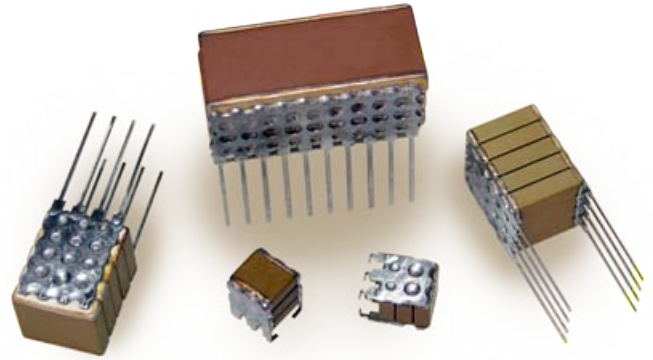

**Dimensions - inches/mm**

Case code	5	4	3	
<b>C</b>	$\pm 0.025$ inches: $\pm 0.635$ mm:	0.250 6.35	0.400 10.16	0.450 11.43
<b>Dmin</b>	inches: mm:	0.224 5.69	0.350 8.89	0.950 24.13
<b>Dmax</b>	inches: mm:	0.275 6.99	0.425 10.80	1.075 27.30
<b>Emax</b>	inches: mm:	0.300 7.62	0.440 11.18	0.500 12.70
<b>Leads per side</b>		3	4	10

For dimensions A and B please refer to DSCC 87106

**Lead Style N**

- Dimension E: Lead length
- Dimension C: Lead spacing
- Dimension D: Body width
- Dimension A: Body height
- Dimension B: Lead height
- Lead thickness:  $0.010$  (0.25)

**Lead Style J**

- Dimension E: Lead length
- Dimension D: Body width
- Dimension A: Body height
- Dimension B: Lead height
- Lead thickness:  $0.070 \pm 0.010$  (1.78  $\pm$  0.25)

Other dimensions shown in drawing:

- Lead pitch:  $0.100$  (2.54)
- Lead diameter:  $0.025$  min /  $0.100$  max (0.63 min / 2.54 max)
- Lead diameter:  $0.020 \pm 0.002$  (0.51  $\pm$  0.05)
- Lead diameter:  $0.055 \pm 0.010$  (1.40  $\pm$  0.25)
- Lead diameter:  $0.250$  min (6.35 min)

**Lead style N - DSCC 87106 Dash Numbers**

Voltage	Case code	5	4	3
50V	Dash#	001-020	021-028	029-040
	Cap value	105-565	825-156	186-476
	Dash#	•	222-223	•
100V	Dash#	055-072	073-082	083-092
	Cap value	684-335	395-825	126-276
	Dash#	•	•	229-230
200V	Dash#	113-126	127-136	137-148
	Cap value	474-155	185-395	475-126
	Dash#	173-190	191-198	199-208
500V	Cap value	154-684	105-185	275-565
	Dash#	•	231-232	233-234
	Cap value	•	824	225

**Lead style J - DSCC 87106 Dash Numbers**

Voltage	Case code	5	4	3
50V	Dash#	241-260	261-270	271-282
	Cap value	105-565	685-156	186-476
	Dash#	301-318	319-328	329-340
100V	Cap value	684-335	395-825	106-276
	Dash#	361-374	375-384	385-396
	Cap value	474-155	185-395	475-126
200V	Dash#	421-438	439-448	449-460
	Cap value	154-684	824-185	225-565

**How to Order - The purchase order or contract must specify the following:**

1	2	3
The Complete DSCC part number - Drawing Number <i>and</i> Dash Number Example: 87106-222	Whether you want Novacap to perform the Group B Test, or provide a certification of compliance for Group B requirement.	Specify requirements for packaging.

# Product Reliability Groups



Novacap's management has defined and documented our Quality Policy.

Quality at Novacap is the enhancement of customer satisfaction by meeting our customer requirements in all our dealings with

*Our Customers  
Our Vendors  
The Environment*

Our system for quality is to attain effective, continuous, measurable improvement through systematic prevention of defects and errors in all activities.

Quality and customer satisfaction are the responsibility of every Novacap employee.

## Certifications and Approvals

Novacap is certified to ISO 9001:2008, Certificate #FM75371.

10 DSCC approvals for radial leaded high voltage capacitors rated 1KV through 10KV. (87043, 87046, 87040, 87047, 87114, 87076, 89044, 87070, 87077, and 87081)

DSCC approval for 87106 stacked leaded switch mode power supply capacitors.

UL, TÜV and CSA approvals for Isolation Surge Protection Capacitors, Class Y<sup>2</sup> and Y<sup>3</sup> in both COG and X7R dielectrics.



**ISO 9001:2008**  
FM 75371



	Standard Commercial Capacitors	HH MIL-PRF-38534 Class H	HB MIL-PRF-55681	HK MIL-PRF-38534 Class K	HS MIL-PRF-123
Standard	■	■			
High Reliability			■	■	■
<b>Typical Termination Options</b>					
P: Silver Palladium	■	■	■	■	■
N: Silver base with Nickel Barrier (100% Matte Tin Plating)	■	■	□	□	□
Y: Silver base with Nickel Barrier (Tin/Lead Plating with min 10% Lead)	■	■	■	■	■
C: FlexiCap™ with Nickel Barrier (100% Matte Tin Plating)	■	■	□	□	□
D: FlexiCap™ with Nickel Barrier (Tin/Lead Plating with min 10% Lead)	■	■	■	■	■
■ Termination available. □ Termination available but generally not requested for Military/Space Grade components. Please discuss with Novacap Sales.					
<b>Documentation</b>					
Certificate of Conformance	S	S	S	S	S
Electrical Test Report (10 piece read and record report)	O	S	O	S	O
Full Data Package	O	O	S	S	S
S = Test conducted as standard. O = Optional test. Please discuss with Novacap Sales.					

	Standard Commercial Capacitors	HH MIL-PRF-38534 Class H	HB MIL-PRF-55681	HK MIL-PRF-38534 Class K	HS MIL-PRF-123
Destructive Physical Analysis (DPA)	S	S	S	S	S
CSAM (C-Mode Scanning Acoustic Microscopy)	O	O	O	O	O
Plating Thickness Verification	S	S	S	S	S
Solderability*	S	S	S	S	S
Electrical Characteristics (DWW, IR, Cap, DF)	S	S	S	S	S
Sample Visual Inspection	S	S	S	S	S
100% Visual Inspection	O	O	O	S	S
Thermal Shock -55°C to +125°C	O	O	O	O	S
100% Burn-In**	O	O	S	S	S
100% Hot IR	O	O	O	O	S
Hot IR sample test (at rated voltage)	O	O	S	S	S
10 Piece Sample Temp Cycling, Constant Acceleration, Burn-In	O	O	O	S	O
Life Sample Test	O	O	O	O	O
Humidity Sample Test	O	O	O	O	O
Resistance to Soldering Heat Sample Test	O	O	O	O	O
Terminal Strength Sample Test	O	O	O	O	O
Group B Testing	N/A	N/A	N/A	N/A	O
Group C Testing	N/A	N/A	O	O	O

**S** = Test conducted as standard.

**O** = Optional test. Please discuss with Novacap Sales.

\* Solderability and plating thickness verification does not apply to palladium/silver terminations.

\*\* Burn-In for MIL-PRF-55681 and MIL-PRF-38534 Class K is 100 hours. Burn-In for MIL-PRF-123 is 168 to 264 hours.

# Lot Test Details



<b>DPA</b>	Destructive Physical Analysis, Device is mounted in an epoxy plug and cross sectioned, with a fine grit sand paper while examining the internal construction of the device per relevant sections of EIA 469 and NOVACAP's internal design criteria.
<b>CSAM</b>	C-Mode Scanning Acoustic Microscopy; A method of non-destructive analysis is of the internal construction of a device per MIL-PRF-123. The optional test is to assure the highest quality of internal microstructure.
<b>Plating Thickness Verification</b>	X-Ray fluorescent (XRF) equipment/instrument is utilized to verify the plating thickness of a device according to NOVACAP's criteria.
<b>Solderability</b>	Determines the ability for solder to wet/adhere to the termination by dipping the component into molten solder according to MIL-STD-202 Method 208.
<b>Electrical Characteristics (DWV, IR, Cap, DF)</b>	DWV: Dielectric Withstanding Voltage, Determines the ability of the dielectric to withstand accelerated voltage without breaking down. IR: Insulation Resistance; The insulation resistance is a measure of the capability of a material To withstand leakage of current under a VDC potential gradient.
<b>Sample Visual Inspection</b>	Is an AQL level inspection, which is based on lot size and consists of a bulk scan under microscope between 7-10X magnification.
<b>100% Visual Inspection</b>	Each side of every part in a lot is subjected to inspection under microscope between 7-10X magnification in accordance with MIL-PRF-123 Appendix B.
<b>Thermal Shock -55°C to +125°C</b>	Devices are subjected to sudden temperature extremes (hot and cold) to determine the physical integrity of the components. All parts receive 20 cycles in accordance with MIL-PRF-123.
<b>100% Burn-In</b>	A method of screening infantile failures by testing at accelerated conditions. Product groups HB and HK follow the guidelines of MIL-PRF-55681. The parts receive a 100% Burn-in at 125°C and a voltage specified in page 27 for 100 hours. Product group HS follows the guidelines of MIL-PRF-123. The parts receive a 100% Burn-in at 125°C and a voltage specified in page 27 for a minimum of 168 and a maximum of 264 hours. The Burn-In may be terminated at any time between the hours of 168 and 264 when failures are less than 0.1% or 1 pieces during the last 48 hours of the test.
<b>100% Hot IR</b>	Tested for IR at rated voltage and elevated temperatures.
<b>Hot IR sample test</b>	A sample that is tested for IR at rated voltage and elevated temperatures.
<b>10 Piece Sample Temp Cycling, Constant Acceleration, Burn-In</b>	The 10 piece sample is tested in accordance with MIL-PRF-38534 TABLE C-III Subgroup 3. The tests include Temperature Cycling per MIL-STD-883 Method 1010 Condition C, Constant Acceleration per MIL-STD-883 Method 2001 with 3,000g's in Y1 direction, Burn-in according to MIL-PRF-55681, and Visual inspection.
<b>Life Sample Test</b>	A test that determines the long-term reliability of a device that is performed at accelerated electrical and environmental conditions. Life test for product groups HH, HB, and HK shall be in accordance with MIL PRF-55681. Life test for product group HS shall be in accordance with MIL-PRF-123.
<b>Humidity Sample Test</b>	Humidity, steady state, low voltage test in accordance with MIL-PRF-202 method 103 condition A with the capacitor requirements of MIL-PRF-55681/MIL-PRF-123. A twelve piece sample is tested with accept on zero failures.
<b>Resistance to Soldering Heat Sample Test</b>	The ability of a device to withstand soldering temperatures. Capacitors shall be tested in accordance with MIL-STD-202 Method 210 with applicable detail of MIL-PRF-55681/MIL-PRF-123.
<b>Terminal Strength Sample Test</b>	It is the strength of the adhesion of the termination to the ceramic body. Capacitors shall be tested in accordance with MIL-STD-202 Method 211 Test Condition A with applicable details of MIL-PRF-123. A six piece sample is tested with accept on zero failures.
<b>Group B Testing</b>	Group B environmental testing for product group HS shall consist of the tests specified in table XII of MIL-PRF-123 and shall be performed on sample units from lots that have been subjected to and have passed group A inspection. Copies of Group B data shall be forwarded to purchaser with parts. Parts may not be shipped until the conclusion of life test.
<b>Group C Testing</b>	Group C environmental testing shall consist of the tests specified in table XI of MIL-PRF-55681 for product groups HB and HK. Testing shall consist of the tests specified in table XIII of MIL-PRF-123 for product group HS. Tests shall be performed on sample units from lots that have been subjected to and have passed group A inspection. Copies of Group C data shall be forwarded to purchaser with parts. Parts may not be shipped until the conclusion of life test.

## Harsh Environments

- Gas and oil well logging
- Geothermal
- Military/Aerospace

Novacap offers a range of high temperature, high reliability, and stable capacitors designed and tested to operate from -55°C to 150°C, 160°C, 200°C and 230°C in both Class I and Class II dielectric product families. Our proprietary dielectric formulations, voltage derating, special design criteria and testing regimen insure stable capacitance at temperature, voltage and frequency. Novacap High Temperature capacitors are available in both SMT and Leaded formats. When even MIL-spec capacitors don't stand up, our products are ideally suited for critical circuitry in extreme conditions.

A novel dielectric, designated H, with maximum +5% capacitance change over the temperature range of 25°C to 230°C offers design advantages where capacitance change over temperature cannot be tolerated.

In many applications such as avionics where temperature variations occur very quickly as altitude is achieved temperature stability becomes critical.

Other applications such as battle field electric power, inverters, DC/DC converters and spacecraft require the temperature/capacitance stability and performance characteristics of this novel dielectric composition. Currently many of these applications use conventional ferroelectric material systems such as X7R, X8R and BX materials. Enhanced electrical performance characteristic of H product will improve performance and may offer the opportunity to down size capacitor requirements.

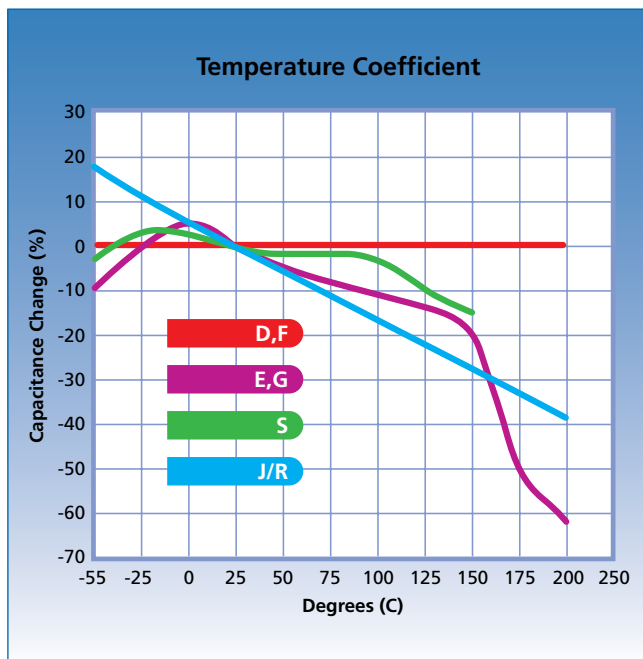
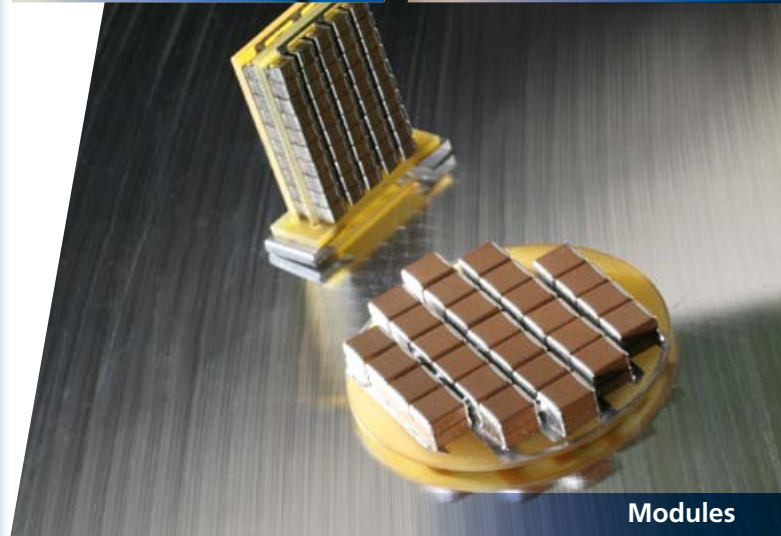
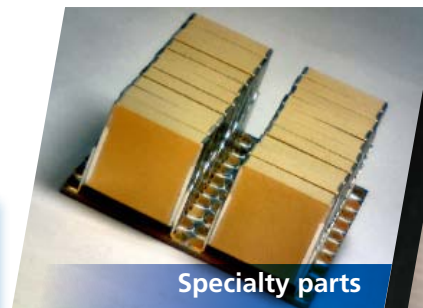



# High Temperature Chip

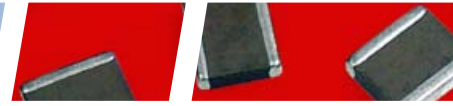

A range of chip capacitors, available in sizes 0805 to 7565, designed to operate from -55°C to 150°C, (Class 2 dielectric) and from -55°C to 200°C (COG & Class II dielectrics). Voltage ratings of 25V to 4kV.

- For dielectric characteristics see pages 4 & 7.
- For dimensions see page 12.
- For termination options see pages 3 & 15.
- For ordering information, inc. tolerances available, see page 15.

**Note:** Maximum capacitance values are shown below as 3 digit code: 2 significant figures followed by the no. of zeros e.g. 183 = 18,000pF.

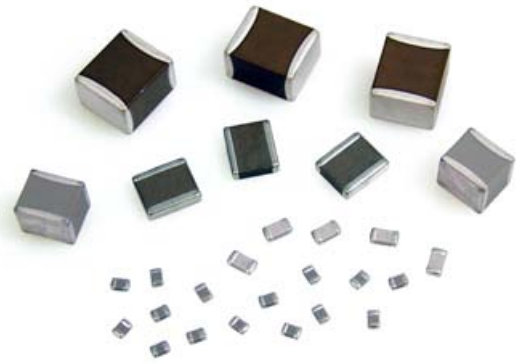

## Maximum capacitance values - 150°C X8R (S) dielectric

Size	0805	1206	1210	1812	1825	2225	4540	7565
Min cap.	121	221	221	221	102	102	102	222
25V	563	184	334	684	125	155	565	156
50V	473	154	274	564	105	125	475	126
100V	333	104	184	394	824	105	395	106
250V	183	333	823	154	474	564	275	695
500V	562	153	393	563	124	154	125	325

## Maximum capacitance values - 160°C COG (F)/Class II (G) and 200°C COG (D)/Class II (E) dielectrics

Size	0805		1206		1210		1515		1808		1812		1825		2225		3530		4540		6560		7565	
Min cap.	OR5	121	1R0	121	5R0	121	5R0	151	120	151	220	151	330	471	470	471	221	102	390	102	560	222	101	222
Tmax inches:	0.054		0.064		0.065		0.130		0.065		0.065		0.080		0.080		0.250		0.300		0.300		0.300	
mm:	1.37		1.63		1.65		3.30		1.65		1.65		2.03		2.03		6.35		7.62		7.62		7.62	
Dielectric	COG	Class II	COG	Class II	COG	Class II	COG	Class II	COG	Class II	COG	Class II	COG	Class II	COG	Class II	COG	Class II	COG	Class II	COG	Class II	COG	Class II
25V	272	823	562	224	123	394	223	824	123	334	223	684	563	155	563	185	104	395	184	565	334	156	394	186
50V	182	473	392	124	822	224	183	684	822	274	153	474	393	105	473	125	823	275	154	475	274	126	334	156
100V	681	183	182	473	332	104	103	274	332	823	822	154	153	474	183	474	563	225	104	335	224	825	274	126
250V	181	472	102	103	222	273	392	683	222	223	562	473	123	124	183	154	333	564	563	125	124	275	154	395
500V	101	102	391	222	821	562	272	183	102	562	222	103	392	273	562	333	123	124	273	334	563	684	683	824
1kV	470	181	101	391	221	821	821	272	221	821	561	152	821	472	102	562	562	273	153	683	333	154	393	224
2kV	•	•	270	•	560	151	181	561	560	•	121	221	181	561	271	681	152	682	332	183	822	393	103	473
3kV	•	•	•	•	•	•	820	•	220	•	560	•	820	•	101	•	561	272	152	682	332	153	392	183
4kV	•	•	•	•	•	•	470	•	120	•	270	•	330	•	470	•	331	122	821	272	182	562	222	822

# High Temperature Radial Lead Epoxy Coated

A range of Radial Leaded Capacitors available in sizes 1515 to 7565 designed to operate from -55°C to 200°C in COG (NP0) & Class II dielectrics with voltage ratings of 25V to 4kV. These capacitors find typical application in harsh environments such as Oil Exploration and Automotive/Avionics engine compartment circuitry. The epoxy coating ensures environmental protection and a rugged configuration for optimum performance. They are also offered without the conformal coating for less harsh environmental applications.

- For dielectric characteristics see pages 4 & 7.
- Capacitance tolerances  $\pm 1\%^*$ ,  $\pm 2\%^*$ ,  $\pm 5\%$ ,  $\pm 10\%$ ,  $\pm 20\%$  (\*COG only)
- For ordering information see page 26.



## Dimensions - inches/mm

Lead Style	LG with black epoxy coating - LO without						
Size	1515	1812	2520	3530	4540	6560	7565
Wmax inches: mm:	0.250 6.35	0.300 7.62	0.370 9.40	0.470 11.90	0.570 14.50	0.770 19.60	0.870 22.10
Hmax inches: mm:	0.250 6.35	0.200 5.08	0.300 7.62	0.400 10.20	0.500 12.70	0.720 18.30	0.770 19.60
Tmax inches: mm:	0.190 4.83	0.160 4.06	0.240 6.10	0.310 7.87	0.360 9.14	0.360 9.14	0.360 9.14
S inches $\pm 0.02$ : mm $\pm 0.508$ :	0.170 4.32	0.200 5.08	0.280 7.10	0.380 9.65	0.480 12.20	0.680 17.30	0.780 19.80

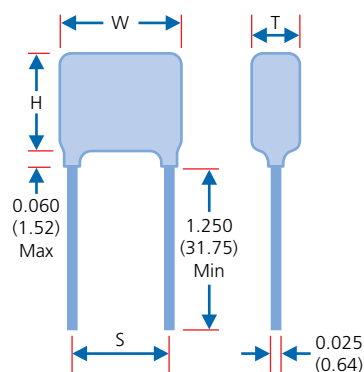

## Maximum capacitance values - 200°C COG (D)/Class II (E) dielectrics

Size	1515		1812		2520		3530		4540		6560		7565	
Min cap.	5R0	151	220	151	390	102	390	102	390	102	560	222	101	222
Dielectric	COG	Class II	COG	Class II	COG	Class II	COG	Class II	COG	Class II	COG	Class II	COG	Class II
25V	223	824	273	105	563	225	104	395	184	565	334	156	394	186
50V	183	684	223	654	563	185	823	275	154	475	274	126	334	156
100V	103	274	103	274	333	125	563	225	104	335	224	825	274	126
250V	392	823	682	104	153	274	333	564	563	125	124	275	154	395
500V	272	183	332	223	562	563	123	124	273	334	563	684	683	824
1kV	821	272	102	332	182	123	562	273	153	683	333	154	393	224
2kV	181	561	221	681	391	222	152	682	332	183	822	393	103	473
3kV	820	221	101	221	181	821	561	272	152	682	332	153	392	183
4kV	470	•	•	•	101	221	331	122	821	272	182	562	222	822

**Note:** Maximum capacitance values are shown above as 3 digit code: 2 significant figures followed by the no. of zeros e.g. 183 = 18,000pF. R denotes decimal e.g. 2R7 = 2.7pF.

# High Temperature Radial Lead Encapsulated

A range of Radial Leaded Capacitors available in sizes 1515 to 7565 designed to operate from -55°C to 200°C in COG (NPO) & Class II dielectrics. Voltage ratings of 25V to 500V. These capacitors find typical application in very harsh environments where isolation and protection of the device is required for optimum reliability. They are also offered without the molded case for less harsh environmental applications. Consult the Sales Office if your specific requirements exceed our catalog maximums (size, cap. value and voltage).

- For dielectric characteristics see pages 4 & 7.
- Capacitance tolerances  $\pm 1\%$ \*,  $\pm 2\%$ \*,  $\pm 5\%$ ,  $\pm 10\%$ ,  $\pm 20\%$  (\*COG only)
- For ordering information see page 26.

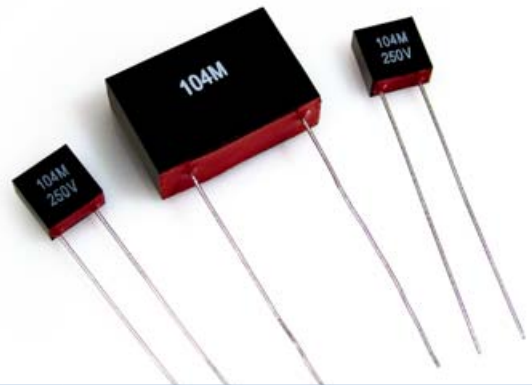

## Dimensions - inches/mm

Lead Style	LC with encapsulation - LO without						
Size	1515	2520	3530	4540	5550	6560	7565
W inches $\pm 0.015$ : mm $\pm 0.381$ :	0.300 7.62	0.400 10.20	0.500 12.70	0.725 18.40	0.795 20.20	0.925 23.50	1.125 28.60
H inches $\pm 0.015$ : mm $\pm 0.381$ :	0.300 7.62	0.400 10.20	0.500 12.70	0.500 12.70	0.745 18.90	0.750 19.00	0.750 19.00
T inches $\pm 0.015$ : mm $\pm 0.381$ :	0.150 3.81	0.200 5.08	0.265 6.73	0.325 8.26	0.370 9.40	0.350 8.89	0.375 9.52
S inches $\pm 0.02$ : mm $\pm 0.508$ :	0.170 4.32	0.280 7.10	0.380 9.65	0.480 12.20	0.580 14.70	0.680 17.30	0.780 19.80

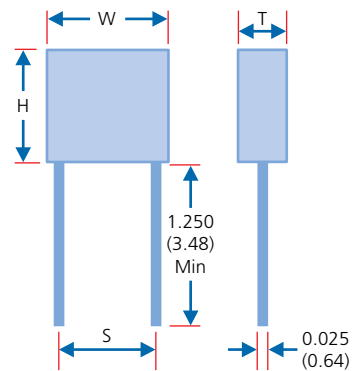

## Maximum capacitance values - 200°C COG (D)/Class II (E) dielectrics

Size	1515		2520		3530		4540		5550		6560		7565	
Min cap.	3R0	221	390	102	390	102	390	102	390	102	560	222	101	222
Dielectric	COG	Class II	COG	Class II	COG	Class II	COG	Class II	COG	Class II	COG	Class II	COG	Class II
25V	183	564	563	225	104	395	184	565	224	106	334	156	394	186
50V	153	394	563	155	823	275	154	475	184	685	274	126	334	156
100V	562	124	273	824	563	185	104	335	154	565	224	825	274	106
250V	392	393	123	184	273	564	563	125	823	225	124	275	154	395
500V	152	822	562	393	123	823	273	224	393	334	563	474	823	684

**Note:** Maximum capacitance values are shown above as 3 digit code: 2 significant figures followed by the no. of zeros e.g. 183 = 18,000pF. R denotes decimal e.g. 2R7 = 2.7pF.

# Certified Safety Capacitors X<sup>2</sup>, Y<sup>3</sup> & X<sup>1</sup>, Y<sup>2</sup>

X<sup>2</sup>, Y<sup>3</sup> (LS style) and X<sup>1</sup>, Y<sup>2</sup> (ES style) Class Compliant\* chip capacitors specifically designed for use in modem, facsimile, telephone and other electronic equipment where lightning or overvoltage surges can occur. Both styles are rated at 250 Vac safety approved with COG (NPO) and X7R dielectrics available (dependant on style).

X<sup>2</sup>, Y<sup>3</sup> (LS style) is certified to EN 60950 and compliant to Standards EN 132400: 1994/A2: 1998/IEC60384-14, Second Edition: 1993/A1:1995.

X<sup>1</sup>, Y<sup>2</sup> (ES style) is certified to IEC60384-14, Second Edition: 1993/A1:1995 and compliant to Standards EN 132400: 1994/A2:1998.

Both styles meet the requirements of EN61000-4-5, IEC1000-4-5 and IEC801-4-5.

## Certification numbers

Safety Classification	X <sup>2</sup> , Y <sup>3</sup>	X <sup>1</sup> , Y <sup>2</sup>
TUV	LS1808N, LS1812N - *T72140287.01 LS1808B - *T72140286.01	ES 1808 - R60012089 ES 2211, ES 2215 - R2072738.01 ES 2225 - R2072738.02
Standards	EN 132400, EN 60950, IEC 60384-14 2nd Edition, Class X <sup>2</sup> Y <sup>3</sup> .	EN 132400, IEC 60384-14 2nd Edition, Class X <sup>1</sup> Y <sup>2</sup>
UL	NWQGQ2.E208336 and NWQGQ8.E208336	

\*LS style is compliant with Robustness of Termination (cl 4.3) test according to IEC 60384-1 amendment 3 cl 4.34 and 4.35 Resistance to Soldering Heat (cl 4.4) tested according to IEC 60384-1 amendment 3 cl. 4.14.2, Impulse Test made with 2.5 KV or 5.0KV as required according to 6.4.2.1 in EN 60950. The creepage distance between live parts of different polarity meets the requirements of IEC 60950.

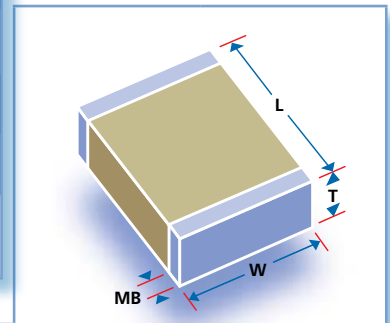

## Dimensions - inches/mm

Safety Classification	X <sup>2</sup> , Y <sup>3</sup>		X <sup>1</sup> , Y <sup>2</sup>			
Size	LS 1808	LS 1812	ES 1808	ES 2211	ES 2215	ES 2225
<b>L</b> inches ±0.015/0.38: mm ±0.015/0.38:	0.180 4.57	0.180 4.57	0.180* 4.57	0.220 5.58	0.220 5.58	0.220 5.58
<b>W</b> inches ±0.02: mm ±0.508:	0.080 2.03	0.125 3.18	0.080** 2.03	0.110 2.79	0.150 3.81	0.250 6.35
<b>MB</b> inches: typical mm:	0.024 0.609	0.024 0.609	0.020 5.08	0.300 0.762	0.300 0.762	0.300 0.762
<b>Creepage</b> inches: min mm:	0.102 2.60	0.102 2.60	0.100 2.50	0.157 3.99	0.157 3.99	0.157 3.99

\*Tolerance is ±0.014/0.35 \*\*Tolerance is ±0.012/0.30

## How to Order - Certified Safety Capacitors

LS	1808	N	122	K	302	N	X080	T	M
<b>STYLE</b> LS = X <sup>2</sup> , Y <sup>3</sup> ES = X <sup>1</sup> , Y <sup>2</sup>	<b>SIZE</b> See Chart	<b>DIELECTRIC</b> N = COG B = X7R	<b>CAPACITANCE</b> Value in Picofarads. Two significant figures, followed by number of zeros: 121 = 120pF	<b>TOLERANCE</b> J = ± 5% K = ± 10% M = ± 20%	<b>VOLTAGE-SURGE</b> Two significant figures, followed by number of zeros: 302 = 3000V (X <sup>2</sup> , Y <sup>3</sup> ) 502 = 5000V (X <sup>1</sup> , Y <sup>2</sup> )	<b>TERMINATION</b> N = Nickel Barrier	<b>THICKNESS OPTION</b> Blank = Standard thickness X = special thickness, specified in inches: X080 = 0.08" X100 = 0.10" X010 = 0.11" X150 = 0.15"	<b>PACKING</b> No suffix = Bulk T = Tape & Reel	<b>MARKING</b> Parts marked: NLS (X <sup>2</sup> , Y <sup>3</sup> ) NY2 (X <sup>1</sup> , Y <sup>2</sup> )

# Certified Safety Capacitors X<sup>2</sup>, Y<sup>3</sup> & X<sup>1</sup>, Y<sup>2</sup>

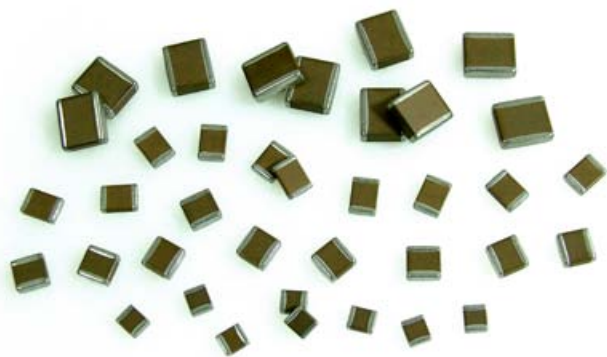

- For dielectric characteristics see page 4 & 7.
- Nickel Barrier terminations.
- Capacitance tolerances available ±5%, ±10%, ±20%

**Note:** Capacitance values are shown below as 3 digit code: 2 significant figures followed by the no. of zeros e.g. 183 = 18,000pF.

## Capacitance values

Safety Classification		X <sup>2</sup> , Y <sup>3</sup>					X <sup>1</sup> , Y <sup>2</sup>				
Size		LS 1808		LS 1812			ES 1808		ES 2211	ES 2215	ES 2225
Tmax	inches: mm:	0.065 1.65	0.080* 2.03	0.065 1.65	0.065 1.65	0.100* 2.54	0.080* 2.03		0.150* 4.00	0.150* 4.00	0.150* 4.00
Dielectric		COG/NPO		X7R	COG/NPO		COG/NPO	X7R	COG/NPO	COG/NPO	COG/NPO
4R7							•				
5R0		•					•	•			
6R8		•					•	•			
8R2		•					•	•			
100		•					•	•			
120		•					•	•			
150		•					•	•			
180		•					•	•			
220		•					•	•			
270		•					•	•			
330		•					•	•			
390		•					•	•			
470		•					•	•			
560		•					•	•			
680		•					•	•			
820		•					•	•			
101		•					•	•			
121		•					•	•			
151		•		•			•	•	•		
181		•		•			•	•	•		
221		•		•			•	•	•		
271		•		•			•	•	•		
331		•		•			•	•	•		
391		•		•			•	•	•		
471		•		•			•	•	•		
561		•		•			•	•	•		
681		•		•			•	•	•		
821			•	•				•			
102			•	•	•			•		•	•
122				•	•						
152				•	•						
182						•					
222						•					

\* Denotes non standard chip thickness.  
Order code needs to have an 'X' inserted together with the dimension in inches -e.g. X080 where dimension is 0.080"

# High Capacitance Chip X7R & X5R

A range of High Capacitance value BME MLC chip capacitors, in stable Class II dielectrics X7R & X5R, with a spread of capacitance values offered up to 100µF. Comparable circuit designs can be achieved at typically a third to a fifth of the capacitance values because of the low ESR characteristics these parts exhibit. As a consequence they are also ideal to replace Tantalum and Low ESR Electrolytic Capacitors without polarity concerns. They find application as power supply bypass capacitors, smoothing capacitors, input/output filters in DC-DC Converters and in digital circuits and LCD modules. Parts are RoHS Compliant and suitable for reflow soldering process.

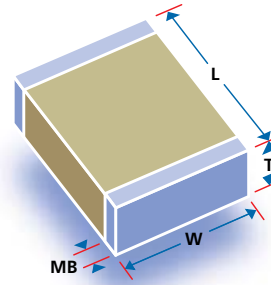

## Comparison with other dielectric capacitors

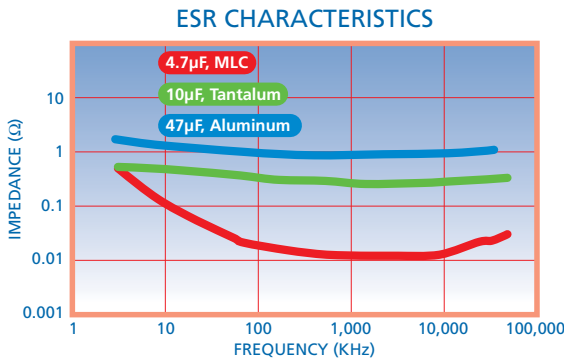
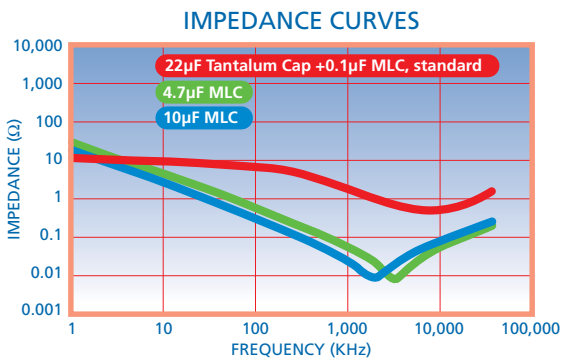

## Dimensions and Tolerances - inches/mm

Size		L	W	MB
0402	inches	0.040 ± 0.004	0.020 ± 0.004	0.010 ± 0.004
	mm	1.02 ± 0.10	0.51 ± 0.10	0.25 ± 0.10
0603	inches	0.063 ± 0.006	0.032 ± 0.006	0.014 ± 0.010
	mm	1.60 ± 0.15	0.81 ± 0.15	0.36 ± 0.25
0805	inches	0.080 ± 0.008	0.050 ± 0.008	0.020 ± 0.010
	mm	2.00 ± 0.20	1.30 ± 0.20	0.51 ± 0.25
1206	inches	0.126 ± 0.008	0.063 ± 0.008	0.020 ± 0.010
	mm	3.20 ± 0.20	1.60 ± 0.20	0.51 ± 0.30
1210	inches	0.126 ± 0.012	0.100 ± 0.012	0.024 ± 0.012
	mm	3.20 ± 0.31	2.50 ± 0.31	0.61 ± 0.31
1812	inches	0.180 ± 0.016	0.125 ± 0.012	0.035 ± 0.020
	mm	4.60 ± 0.41	3.20 ± 0.31	0.90 ± 0.51

Dielectric Characteristics	X7R (BB) Stable	X5R (BW) Stable
Operating temperature range:	-55°C to 125°C	-55°C to 85°C
Temperature coefficient:	±15% ΔC Max.	±15% ΔC Max.
Dissipation factor:	3.5% max except: 0402 ≥ 0.1µF = 5%, 0603 ≥ 0.22µF = 10%, 0805 ≥ 1.0µF = 5%, 0805 ≥ 2.2µF = 10%, 1206 ≥ 2.2µF = 10%, 1210 ≥ 4.7µF = 5%, 1210 ≥ 22µF = 10%	5% max except: 0402 ≥ 1.0µF = 10%, 0603 ≥ 1.0µF = 10%, 0805 ≥ 4.7µF = 10%, 1206 ≥ 4.7µF = 10%, 1210 ≥ 10µF = 10%
Insulation resistance @25°C:	>10GΩ or >100ΩF whichever is less	>10GΩ or >100ΩF whichever is less
Dielectric withstanding voltage:	250%	250%
Aging Rate:	X7R 3.5% typical	X5R 5% typical
Test parameters @ 25°C:	1KHz, 1.0 ±0.2 VRMS	1KHz, 1.0 ±0.2 VRMS 120Hz, 0.5 ±0.1 VRMS for 22µF, 47µF & 100µF

## How to Order - High Capacitance Chip Capacitors

1206	W	476	K	6R3	N	X080	T
<b>SIZE</b> See Chart	<b>DIELECTRIC</b> BB* = X7R BW* = X5R	<b>CAPACITANCE</b> Value in Picofarads. Two significant figures, followed by number of zeros: 476 = 47µF (47,000,000pF)	<b>TOLERANCE</b> K = ± 10% M = ± 20%	<b>VOLTAGE-VDCW</b> Two significant figures, followed by number of zeros. R denotes decimal point: 6R3 = 6.3V 501 = 500V	<b>TERMINATION</b> N = Nickel Barrier (100%tin) Y = Nickel Barrier (90%tin 10% lead) NG = Nickel Barrier Gold Flash	<b>THICKNESS OPTION</b> Blank = Standard thickness X = special thickness, specified in inches: X085 = 0.085"	<b>PACKING</b> No suffix = Bulk T = Tape & Reel
	*Formally B & W codes						

**Note:** BME parts available with added high reliability test. Consult factory.

# High Capacitance Chip X7R & X5R

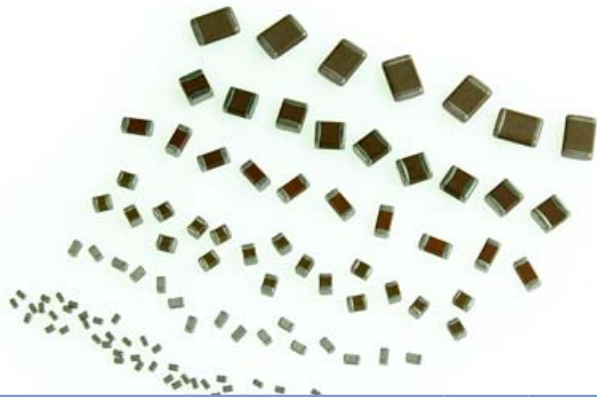

- For dielectric characteristics see page 44.
- Nickel Barrier terminations with tin, tin/lead or gold flash
- Capacitance tolerances available:  $\pm 10\%$ ,  $\pm 20\%$
- Available with high reliability screening. Contact sales office for details

**Note:** Capacitance values are shown below as 3 digit code: 2 significant figures followed by the no. of zeros  
e.g. 183 = 18,000pF.

## Capacitance values

Size	0402		0603		0805		1206		1210				1812	
Tmax	inches:	0.024	0.035		0.054		0.072*		0.085*		0.110*		0.110*	
	mm:	0.61	0.89		1.37		1.83		2.16		2.79		2.79	
Dielectric	X7R	X5R	X7R	X5R	X7R	X5R	X7R	X5R	X7R	X5R	X7R	X5R	X7R	X5R
4V				226†				107†						-
6.3V	224	105 225† 475†		475 106†		226†		476†		476†	476†	107†		-
10V		474	225	475 106†	106†	106	226†	226†		226†		476†		-
16V	153 223 333 473 104	224 474 105	105	225 475	474 105 225 475	475 106	106	106 226†	475† 106†			226†		-
25V	682 103 473	104 224	474 105	224 474 105 225	105 225 475	225 475	225 475 106	475 106	335† 475†	475† 106†	226†			-
35V										225† 475†				-
50V	103	104	224 474	104 474 105	224 474 105	224 474 105	474 105 225 475	475	105		475†	475† 106†		-
100V			104		224		105		105 225				105 225	-

\* Denotes non standard chip thickness. Order code needs to have an 'X' inserted together with the dimension in inches -e.g. X072 where dimension is 0.072".

† Denotes only available in  $\pm 20\%$  capacitance tolerance

# Non Magnetic Chip COG & X7R

This range of MLC chip capacitors that are completely non magnetic. They are designed to operate in non magnetic environments such as Magnetic Resonance Imaging (MRI) and Nuclear Magnetic Resonance (NMR) systems. Copper barrier terminations are available for soldering applications and palladium silver terminations for conductive epoxy. Consult the Sales Office if your specific requirements exceed our catalog maximums (size, cap. value, and voltage).

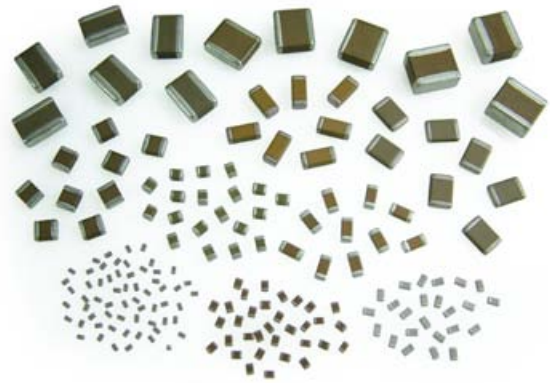

## Capacitance and Voltage Selection

Size	0402		0504		0603		0805		1206		1210		1808		1812		1825		2221		2225	
Min cap.	0R3	121	0R5	121	0R3	121	0R5	121	2R0	121	5R0	121	5R0	151	100	151	150	471	270	471	270	471
Tmax inches: mm:	0.024 0.61		0.044 1.12		0.035 0.89		0.054 1.37		0.064 1.63		0.065 1.65		0.065 1.65		0.065 1.65		0.080 2.03		0.080 2.03		0.080 2.03	
Dielectric	COG	X7R	COG	X7R	COG	X7R	COG	X7R	COG	X7R	COG	X7R	COG	X7R	COG	X7R	COG	X7R	COG	X7R	COG	X7R
16V	470	562	561	393	271	273	122	124	272	334	562	474	562	684	103	125	223	185	183	155	223	225
25V	390	472	471	333	221	223	102	104	272	274	562	474	562	564	103	105	223	155	183	125	223	185
50V	330	472	391	333	181	223	821	104	222	274	472	474	472	394	682	824	223	155	183	125	223	185
100V	330	472	391	333	181	223	821	683	182	184	392	334	332	274	562	564	153	125	123	125	153	155
200V	180	222	221	153	101	103	391	333	102	104	222	184	182	184	392	334	103	824	822	684	123	105
250V	120	152	121	103	680	682	271	273	821	683	152	124	152	124	272	224	822	684	682	564	822	824
300V	•	•	•	•	•	•	181	153	471	473	102	823	102	823	222	154	472	474	472	394	682	474
400V	•	•	•	•	•	•	181	123	391	273	821	563	102	563	222	104	472	334	472	274	682	394
500V	•	•	•	•	•	•	181	103	391	223	821	563	102	563	222	104	472	334	472	274	682	334
600V	•	•	•	•	•	•	151	822	331	183	681	393	821	393	182	683	392	224	392	224	562	274
800V†	•	•	•	•	•	•	151	472	331	103	681	273	821	273	182	473	392	124	392	124	562	154
1kV	•	•	•	•	•	•	820	272	181	682	471	153	471	153	102	273	222	823	222	823	332	104
1.5kV	•	•	•	•	•	•	•	•	101	222	271	472	271	472	561	822	122	273	102	273	152	333
2kV	•	•	•	•	•	•	•	•	680	102	151	222	181	272	391	472	561	123	561	123	821	153
3kV	•	•	•	•	•	•	•	•	•	•	•	•	820	561	181	122	271	472	221	472	331	562
4kV	•	•	•	•	•	•	•	•	•	•	•	•	390	331	101	681	121	152	121	152	181	152
5kV	•	•	•	•	•	•	•	•	•	•	•	•	•	•	•	•	820	821	820	821	121	102

**Note:** Maximum capacitance values are shown above as 3 digit code: 2 significant figures followed by the no. of zeros e.g. 183 = 18,000pF. R denotes decimal e.g. 2R7 = 2.7pF.

- For characteristics of dielectrics M (COG) and C (X7R) see pages 4 & 6.
- For dimensions see page 12.
- For termination options see pages 3 & 15.
- For capacitance tolerances available see page 15.
- For ordering information see page 15.



# Thin Profile Chip

Ultra thin profile chips available in C0G, X7R, Z5U and Y5V dielectrics, and three maximum thicknesses of 0.015", 0.018" and 0.020". These devices find application as decoupling capacitors mounted underneath other circuit elements where space is restricted, and for low profile RFID and "Smart Card" circuitry. Three popular size chips are offered with voltage ratings of 5Vdc to 50Vdc.

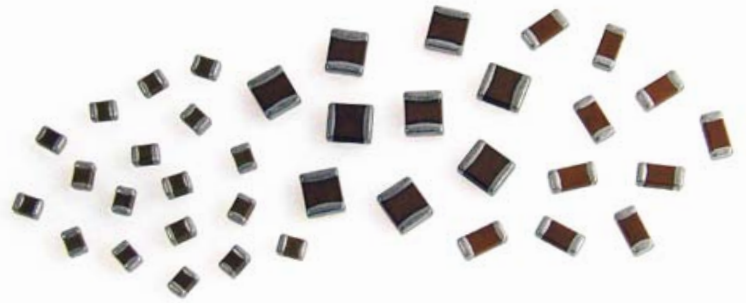

- For dielectric characteristics see pages 4,5 & 6.
- For dimensions see page 12.

## Capacitance values

	Size	0805		1206			1210		
	Tmax inches: mm:	0.015 0.38	0.018 0.46	0.015 0.38	0.018 0.46	0.020 0.51	0.015 0.38	0.018 0.46	0.020 0.51
C0G	5V	102	152	222	332	392	392	682	682
	10V	102	152	222	332	392	392	682	682
	25V	821	122	182	272	272	332	472	562
	50V	561	821	122	182	222	272	392	472
X7R	5V	223	333	473	683	823	823	124	154
	10V	223	333	473	683	683	683	104	124
	25V	153	223	333	563	683	683	104	124
	50V	153	223	333	563	683	683	104	124
Y5V-Z5U	5V	184	274	274	474	564	564	824	105
	10V	184	274	274	474	564	564	824	105
	25V	124	224	224	394	394	474	684	824
	50V	823	124	184	274	334	394	564	684

## How to Order - Thin Profile Capacitors

0805	Y	103	M	250	N	X015	T
<b>SIZE</b> See Chart	<b>DIELECTRIC</b> N = C0G B = X7R Y = Y5V Z = Z5U	<b>CAPACITANCE</b> Value in PicoFarads. Two significant figures, followed by number of zeros: 103 = 10,000pF	<b>TOLERANCE</b> J = ± 5%* K = ± 10%* M = ± 20% Z = +80% -20% P = +100% -0%	<b>VOLTAGE-VDCW</b> Two significant figures, followed by number of zeros: 250 = 25V	<b>TERMINATION</b> N = Nickel Barrier (100% tin) Y = Nickel Barrier (90% tin - 10% lead) P = Palladium Silver	<b>THICKNESS OPTION</b> X = Non standard thickness. Specify in inches: X015 = 0.015" X018 = 0.018" X020 = 0.020"	<b>PACKING</b> No suffix = Bulk T = Tape & Reel*
			*C0G & X7R only				*Please consult the sales office

# Capacitor Assemblies - ST & SM

These ranges of both High Capacitance and High Voltage MLC assemblies are available in COG and X7R dielectrics.

Low ESR and Low ESL are inherent in the design giving the assemblies a high capability up to 1MHz and offer far superior performance than either Aluminum or Tantalum electrolytic capacitors.

They are designed for use in high power or high frequency applications such as switched mode power supplies, DC-DC converters, high capacitance discharge circuits, high temperature filtering/decoupling.

They can be made with up to five same size chips with various lead configurations to safeguard against thermal and mechanical stresses.

The commercial 'ST' series provide the highest capacitance available and are 100% tested for Dielectric Withstanding Voltage, Insulation Resistance, Capacitance, and Dissipation Factor.

In contrast, the High Reliability 'SM' series is designed and tested for military and industrial applications and tested as per of MIL-PRF-49470 (DSCC 87106), Group A.

## Dimensions - inches/mm

### NN or NP (no leads)

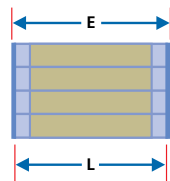
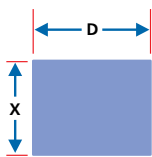

### TJ & TL (tab leads)

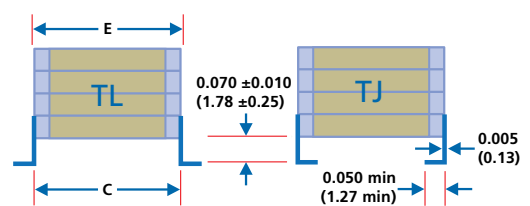
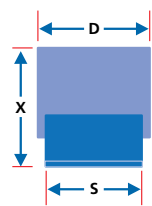

### LN (straight wire leads)

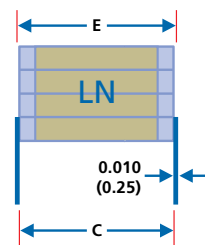
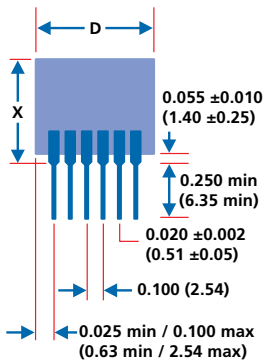

### LJ & LL (bent wire leads)

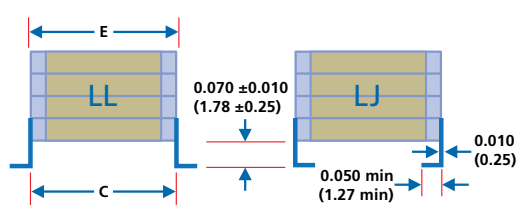
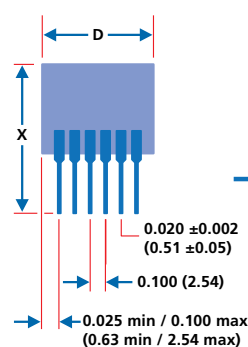

Size	1812	1825	2225	3640	4540	5550	7565
<b>C</b> inches ±0.025/mm ±0.64:	0.210/5.33	0.210/5.33	0.250/6.35	0.400/10.20	0.480/12.20	0.580/14.70	0.780/19.80
<b>D</b> inches ±0.025/mm ±0.64:	0.125/3.18	0.250/6.35	0.250/6.35	0.400/10.20	0.400/10.20	0.500/12.70	0.650*/16.50
<b>E max</b> inches/mm:	0.260/6.60	0.260/6.60	0.300/7.62	0.430/10.90	0.530/13.50	0.630/16.00	0.830/21.10
<b>L nom</b> inches/mm:	0.180/4.57	0.180/4.57	0.220/5.59	0.360/9.14	0.450/11.40	0.550/14.00	0.750/19.10
<b>Leads per side</b>	N/A	3	3	4	4	5	6

\*±0.035/1.89

# Capacitor Assemblies - ST & SM

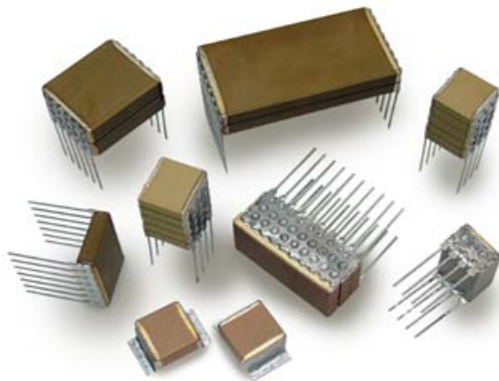

Our complete testing facility is available for any additional military testing requirements.

Options available include thru-hole and surface mount lead styles, to make them suitable for mounting on ceramic substrates or epoxy PCBs.

Consult the Sales Office if your specific requirements exceed our catalog maximums (size, cap. value, and voltage).

## Maximum stack height, X dimension - inches/mm

No. of chips	Chip size	Style NN, NP	Style TJ & TL	Style LN, LJ & LL
1	1812	0.100/2.54	0.180/4.57	N/A
	1825	0.100/2.54	0.180/4.57	0.180/4.57
	2225	0.120/3.05	0.200/5.08	0.200/5.08
	>2225	N/A	0.200/5.08	0.200/5.08
2	1812	0.200/5.08	0.280/7.11	N/A
	1825	0.200/5.08	0.280/7.11	0.280/7.11
	2225	0.240/6.10	0.320/8.13	0.320/8.13
	>2225	N/A	0.320/8.13	0.320/8.13
3	812	0.300/7.62	0.380/9.65	N/A
	1825	0.300/7.62	0.380/9.65	0.380/9.65
	2225	0.360/9.14	0.440/11.2	0.440/11.20
	>2225	N/A	0.440/11.2	0.440/11.20
4	1812	0.400/10.20	0.480/12.2	N/A
	1825	0.400/10.20	0.480/12.2	0.480/12.20
	2225	0.480/12.20	0.560/14.2	0.560/14.20
	>2225	N/A	0.560/14.2	0.560/14.20
5	1812	0.520/13.20	0.600/15.2	N/A
	1825	0.520/13.20	0.600/15.2	0.600/15.2
	2225	0.635/16.10	0.715/18.2	0.715/18.2
	>2225	N/A	0.715/18.2	0.715/18.2

## How to Order - ST & SM Capacitor Assemblies

ST	3640	B	474	M	101	LJ	X	W	-5	R
<b>STYLE</b> ST = Commercial SM = High Reliability	<b>SIZE</b> See Chart	<b>DIELECTRIC</b> N = COG B = X7R	<b>CAPACITANCE</b> Value in Picofarads. Two significant figures, followed by number of zeros: 825 = 8,200,000pF (8.2µF)	<b>TOLERANCE</b> F = ±1%* G = ±2%* H = ±3%* J = ±5% K = ±10% M = ±20% Z = +80 -20% P = +100 -0%	<b>VOLTAGE-VDCW</b> Two significant figures, followed by number of zeros: 101 = 100V	<b>LEAD STYLE</b> LN = Straight* LL = L Lead* LJ = J Lead* TL = L Tab TJ = J tab NN = Nickel* NP = Pd/Ag	<b>THICKNESS OPTION</b> Specify standoff dimension if less than max.	<b>PACKING</b> W = Waffle T = Tape & Reel*	<b>No. Chips</b> 1 to 5	<b>RoHS</b> ≥250V RoHS
				*COG only		*Not 1812		*Consult the sales office		









# Capacitor Assemblies - 'Cap-Rack' Arrays

The Cap-Rack (US Patent 6,058,004) is an assembly of individual chip capacitors, bonded with high temperature epoxy. A Cap-Rack can be made up of a pair, to as many as eight same size chips - 0603, 0805, 1005, 1206, 1210, 1808, 1812, 1825, 2221 and 2225 - into one single component providing extended freedom for PCB space utilization. Footprint dimensions can also vary to further optimize board space usage. The patented design allows the chips to behave as individual components, not as a single large ceramic mass, and therefore reduces harmful thermal stress during assembly. Typical applications are in Multi-line designs, Mobile phones, Automotive, Computers, Network Devices and Medical products.

Electrical advantages include reduction in "cross talk", to insignificant levels, by elimination of capacitance coupling between adjacent capacitors; the ability to combine resistors and inductors within the Cap-Rack, as well as mixing and matching capacitance values and dielectrics.

Mechanical advantages include reduced board area; easier to handle; reduced placement cost; reduces component stress and decreased cycle time. Cap-Rack can also be used with traditional pick and place equipment.

Consult the sales office for High Reliability versions and custom designs, particularly for high voltage applications.

- For dielectric characteristics see page 15.
- For dimensions of individual chips see page 12.
- P & AW dimensions are dependant on the chips utilized in the array.
- Cap Arrays require drawings to specify length and width of array and chip size used. Please contact the sales office.

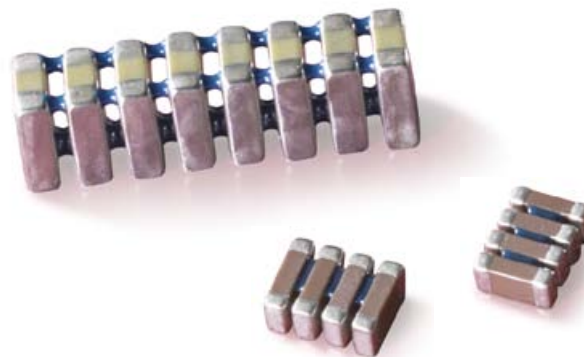

Dimensions - inches/mm

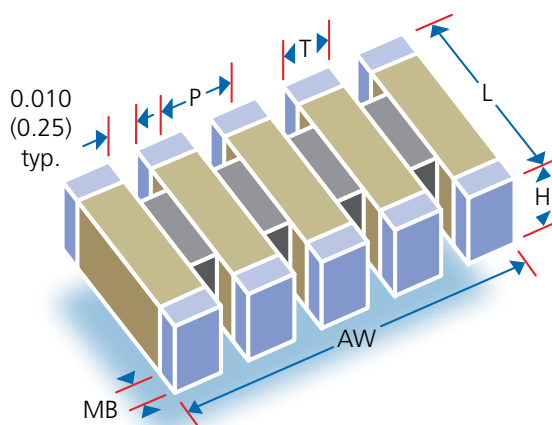

Size	0603	0805	1005	1206	1210	1808	1812	1825	2221	2225
Max number of Caps	6	6	6	6	6	6	8	8	8	8

For capacitance values and voltage offerings for the case sizes shown above please refer to the appropriate dielectric (COG, X7R, Y5V), High Voltage or High Reliability catalog pages.

## How to Order - 'Cap-Rack' Arrays

CR	1206	N	562	K	101	N	H	T	- 4
<b>STYLE</b>	<b>SIZE</b>	<b>DIELECTRIC</b>	<b>CAPACITANCE</b>	<b>TOLERANCE</b>	<b>VOLTAGE VDCW</b>	<b>TERMINATION</b>	<b>HI-REL OPTION</b>	<b>PACKING</b>	<b>No. of chips</b>
Cap-Rack	Size of individual chips that make up the array	N = COG B = X7R Y = Y5V	Value in Picofarads. Two significant figures, followed by number of zeros: 562 = 5600pF	B = 0.10pF* C = 0.25pF* D = 0.50pF* F = ± 1.0%* G = ± 2.0%* H = ± 3.0%* J = ± 5% K = ± 10% M = ± 20% Z = +80% -20% P = +100% -0%  *COG only	Two significant figures, followed by number of zeros: 101 = 100V	N = Nickel Barrier (100% tin) P = Palladium Silver Y = Nickel Barrier (90% tin/ 10% lead)	Ref: MIL-PRF-55681 & MIL-PRF-123	T = Tape & Reel W = Waffle Pack	



# Your Premier Source for Specialty Products

Novacap is recognized as a leading supplier of specialty multilayer ceramic capacitors, differentiated by offering a wide range of high-voltage, high-reliability, high-temperature and high-energy components for specialized applications. Application specific custom chips and modules are available, operating from 1.5V to >20KV and sized from 0201 to >7560 throughout a range of material options. Modular units in series/parallel arrangements are offered.

Novacap Specialty Components takes it one step further. Our catalog is only the starting point. Our unique dielectric systems coupled with a "Can Do" attitude and a multi-disciplined engineering staff can create and manufacture capacitors and modules impossible to find off the shelf. Have an unusual package size? We can do that. Have a non-standard capacitance/voltage requirement? We can do that. Need to take to the extremes of temperature and shock/vibration? We can do that too!

Novacap excels at application specific ceramic capacitor solutions for unique applications. We possess a full machine shop that affords the customer quick development times and lower NRE charges. We have extensive tooling and screens for a wide variety of sizes other than EIA and what is listed in this catalog. Novacap's R&D and Engineering Departments have extensive industry experience to provide a solution for your application. Please consult the factory with your specific requirements.

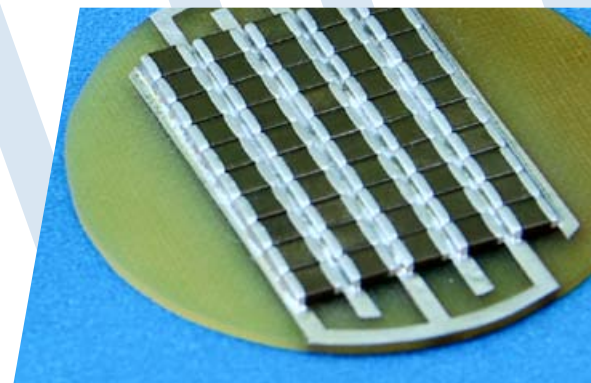
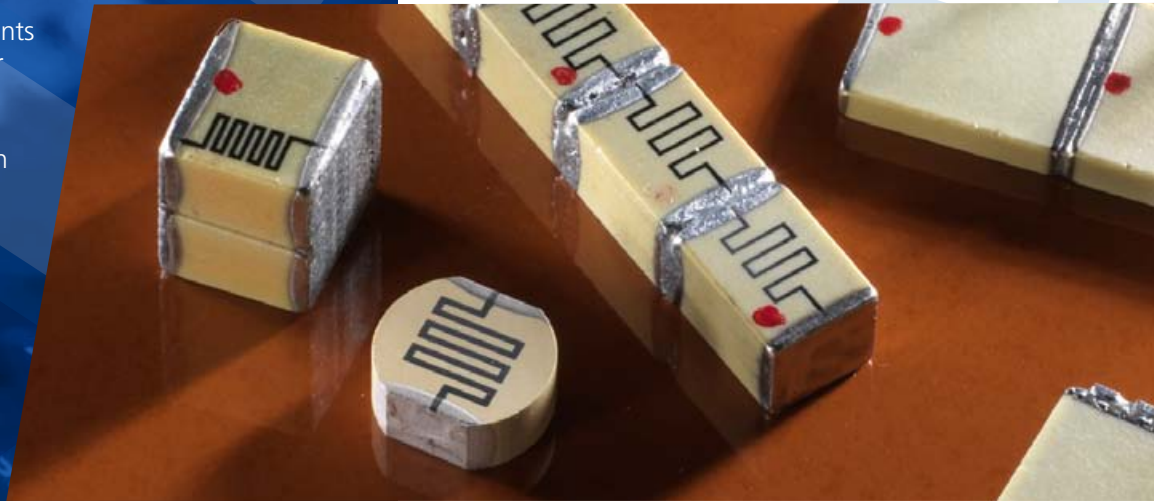
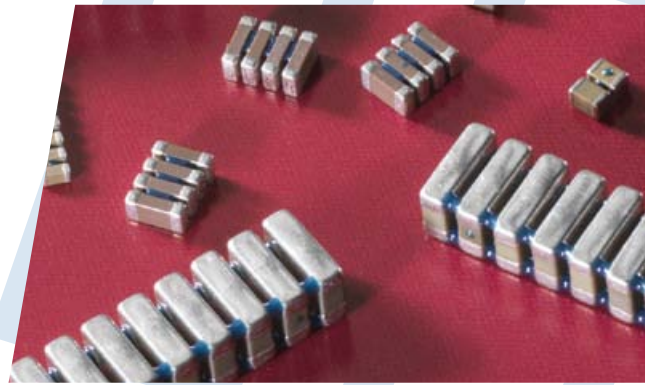

# Specialty Products

## Detonator & Pulse Energy

- In sizes 1825, 2225, 3040, 3640, 6560
- Designed for oil field exploration and perforation

These high temperature, high energy, capacitors are manufactured with a dielectric formulation designed for reliable operation under single or multiple pulse firing applications. Energy density exceeds that of conventional Class 1 materials and offers excellent short duration pulse delivery at temperatures to 200°C. Discharge pulse width which is typically less than 100 nanoseconds will vary with load conditions which are influenced by inductive and resistive load components.

All parts are 100% tested to Novacap High Reliability Pulse Screening tests and are evaluated at temperature extremes up to 200°C consistent with munitions and oil field exploration/seismic detonation conditions.

As an added safety feature, these pulse discharge capacitors can be supplied with integral bleed resistors at various resistance values. With exceptionally low ESR and low signal distortion, additional applications at high temperature include power supply filtering, energy storage and coupling/decoupling. When operated at temperatures less than 200°C, higher capacitance values are available.

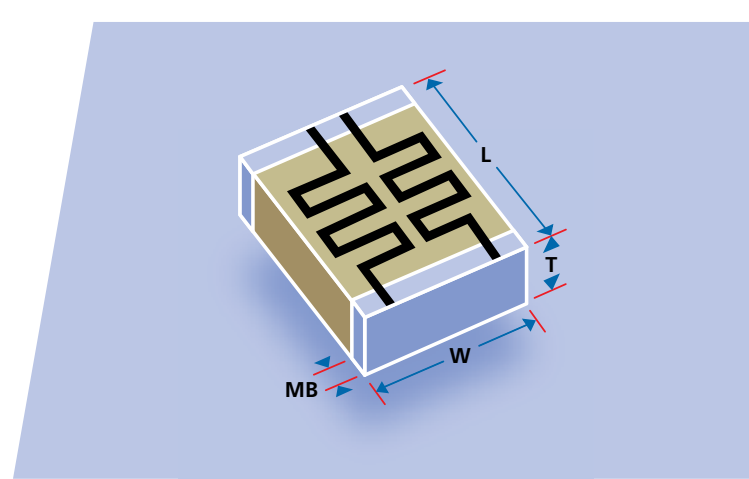

### Dimensions - inches/mm

Size	1825	2225	3040	3640	6560
<b>Length L</b>	0.180/4.57 ±0.012/0.31	0.220/5.59 ±0.015/0.38	0.300/7.62 ±0.015/0.38	0.360/9.14 ±0.018/0.46	0.750/19.10 ±0.038/0.97
<b>Width W</b>	0.250/6.35 ±0.015/0.38	0.250/6.35 ±0.015/0.38	0.400/10.20 ±0.015/0.38	0.400/10.20 ±0.020/0.51	0.650/16.50 ±0.033/0.84
<b>Tmax inches - mm:</b>	0.150/3.81	0.150/3.81	0.250/6.35	0.200/5.08	0.300/7.62

### Pulsed Power - Capacitance and Voltage Selection

Size	1825	2225	3040	3640	6560
<b>1kV</b>	473	683	174	204	594
<b>1.5kV</b>	223	393	124	144	404

**Note:** 1) Maximum capacitance values are shown above as 3 digit code: 2 significant figures followed by the no. of zeros e.g. 473 = 47,000pF  
 2) Capacitance values at 25°C, 1vrms & 1kHz. Additional case sizes & voltages available. Listed capacitance values and performance characteristics are for reference only.

# Specialty Products

## Detonator & Pulse Energy

Other sizes, voltages and capacitance ratings are available in single, series and series/parallel arrangement for custom applications.

500 Megohm safety bleed resistor are standard but other values are available.

Please consult the sales office to best determine part size needed to meet your application requirements.

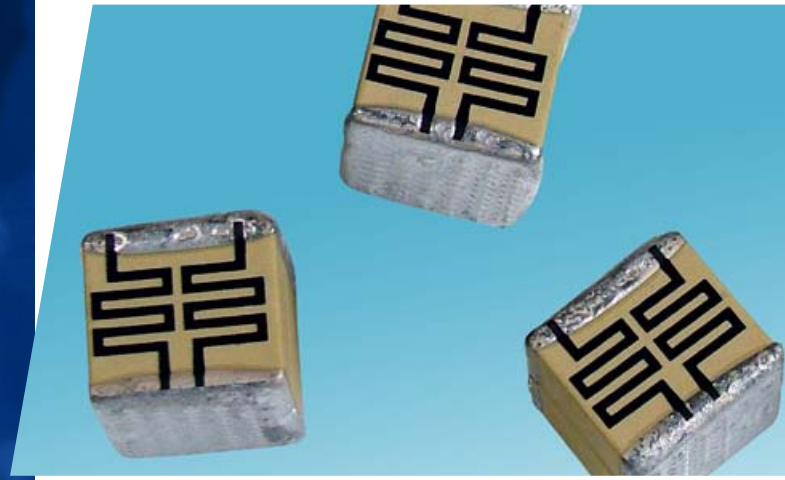

### Dielectric Characteristics - Pulse Energy (R)

Operating temperature range:	-55°C to 200°C
Temperature coefficient:	-2200 ±500 ppm/°C
Dissipation factor @ 25°C:	0.1% Max.
Insulation resistance @25°C: >100GΩ or >1000ΩF whichever is less @200°C: >1GΩ or >10ΩF whichever is less	
Dielectric withstanding voltage:	120%
Ageing rate:	0% per decade
Test parameters:	1KHz, 1.0 ±0.2 VRMS, 25°C

### Temperature-Capacitance Coefficient

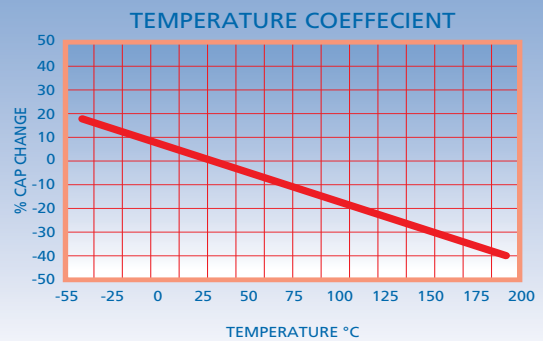

### Voltage-Capacitance Coefficient

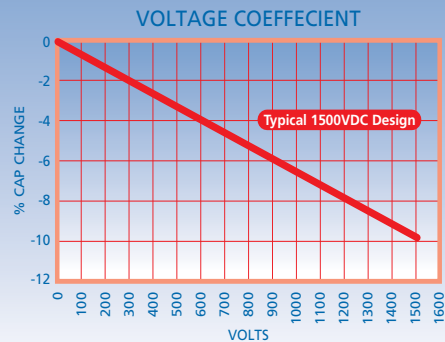

### How to Order - Detonator & Pulse Energy

RC	3640	R	124	K	102	P	X	T
<b>STYLE</b> RC = Bleed Resistor (optional)	<b>SIZE</b> See chart	<b>DIELECTRIC</b> R = R2D	<b>CAPACITANCE</b> Value in Picofarads. Two significant figures, followed by number of zeros: 124 = 120,000pF	<b>TOLERANCE</b> J = ± 5.0% K = ± 10% M = ± 20% Z = +80-20% P = +100-0%	<b>VOLTAGE VDCW</b> Two significant figures, followed by number of zeros: 102 = 1000V	<b>TERMINATION</b> K = Palladium Silver for Lead Free Solder P = Palladium Silver	<b>THICKNESS</b> Size 1825 & 2225 require an X in the part number.	<b>PACKING</b> T = Reeled

# Specialty Products

Custom Designs



## High Voltage Encapsulated Assemblies

Series-parallel assemblies encapsulated for harsh environments.

## Specialty Feed Thru Capacitors

Feed Thru/High Current units for pacemaker/defibrillator applications. These units provide signal conduits through openings while suppressing EMI and RFI interference. Manufactured to customer SCD.  
(Patent numbers 5,825,608 & 6,058,004)

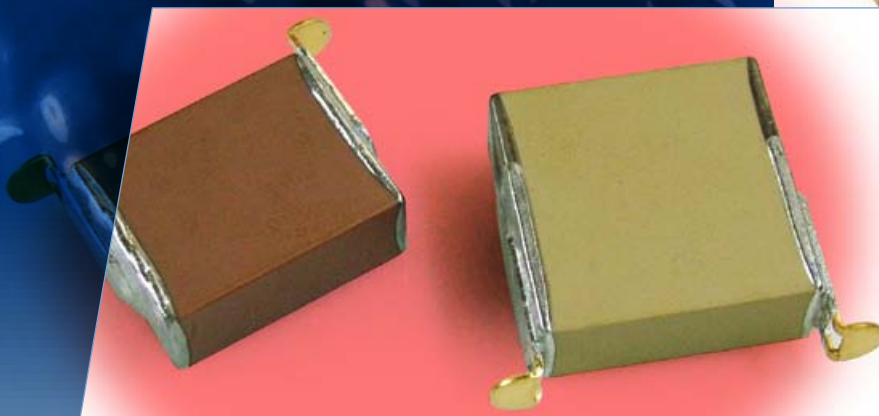

## Vertical Mount Capacitor

A vertical surface mount of a single large capacitor using specially designed and developed leads to allow for board space savings.

# Specialty Products

Custom Designs

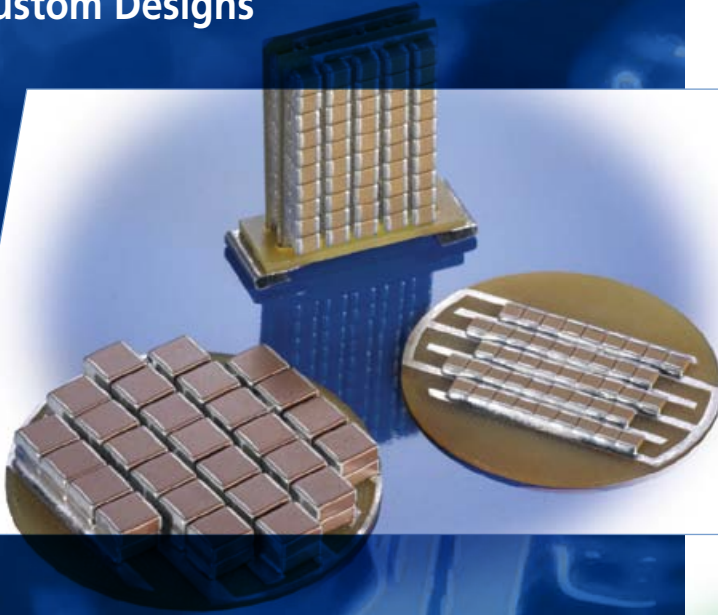

## High Energy Modules

Specifically designed to offer high capacitance value in modular form for single component installation.

## Free Form Capacitors

The Free Form capacitor allows any size geometry and shape for utilization in custom fit applications.

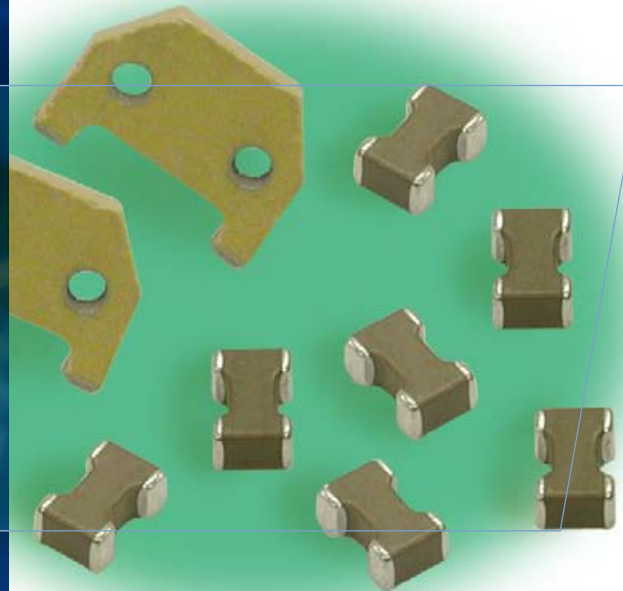

## Vertical Capacitor Assemblies

Novacap is capable of stacking capacitors on the side for applications of limited height.

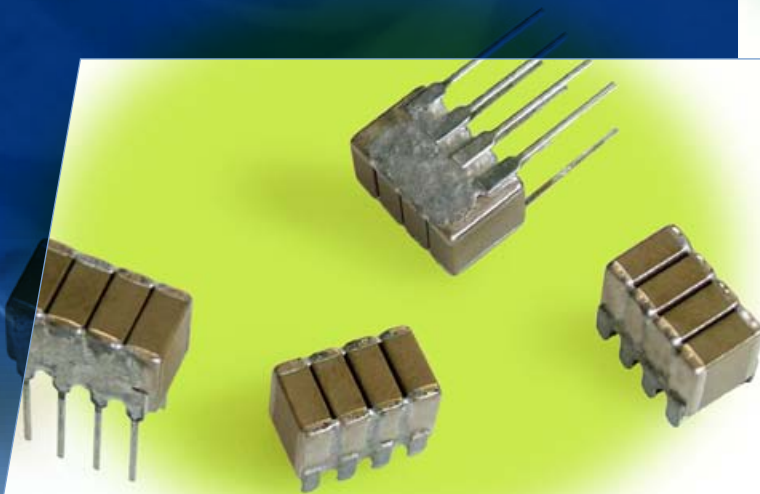



Pulse Capacitors



Munitions



Missiles



Aerospace

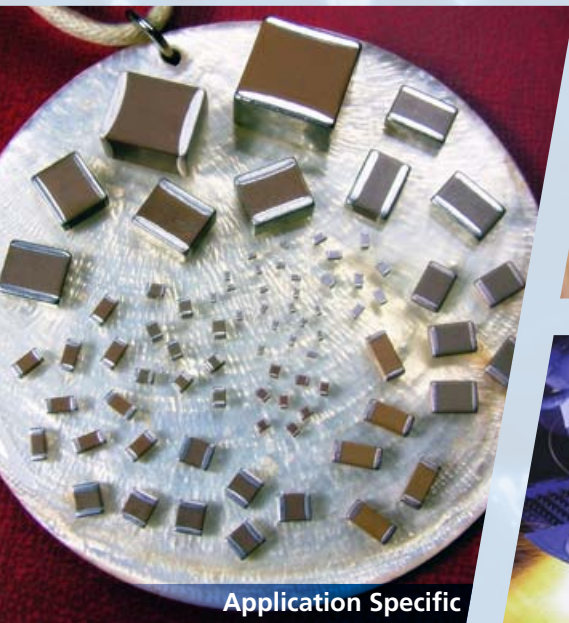

Application Specific

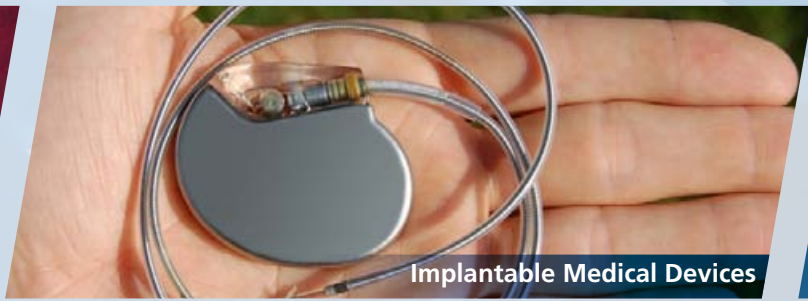

Implantable Medical Devices



Industrial



Specialty Products



Automotive

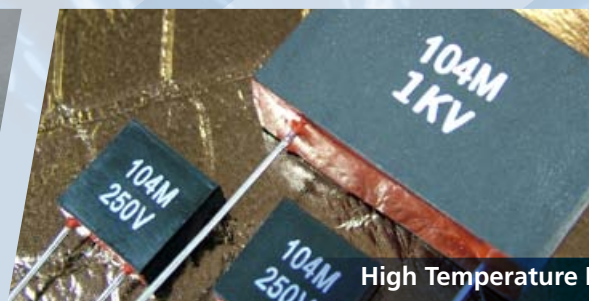

High Temperature

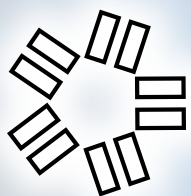

**NOVACAP**



Commercial Products

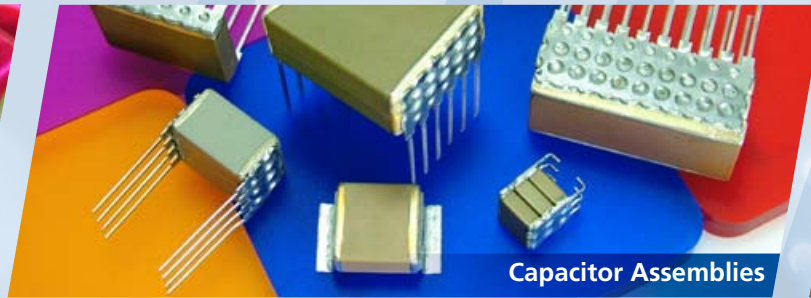

Capacitor Assemblies



Anti-IED



Oil Exploration



MRI



Telecom



Military



Products



High Reliability Products

Multilayer Ceramics for aerospace, automotive, medical, detonation, military, power conversion, tele/Datacom, oil/gas/geothermal exploration and harvesting



 Knowles designs, manufactures and sells special electronic components and systems. Our products are used in military, space, telecom infrastructure, medical and industrial applications where function and reliability are crucial.



Dielectric Laboratories, Inc  
2777 Route 20 East, Cazenovia, NY 13035 USA

 Phone: +1 315 655 8710  
Fax: +1 315 655 0445  
Email: sales@dilabs.com



Novacap  
25111 Anza Drive, Valencia, CA 91355 USA

 Phone: +1 661 295 5920  
Fax: +1 661 295 5928  
Email: info@novacap.com



Syfer Technology Limited  
Old Stoke Road, Arminghall, Norwich, NR14 8SQ UK

 Phone: +44 1603 723300  
Fax: +44 1603 723301  
Email: sales@syfer.co.uk



Voltronics Corporation  
2250 Northwood Drive, Salisbury, MD 21801 USA

 Phone: +1 410 749 2424  
Fax: +1 443 260 2263  
Email: info@voltronicscorp.com