

# LM3509 High Efficiency Boost for White LED's and/or OLED Displays with Dual Current Sinks and I<sup>2</sup>C Compatible Brightness Control

Check for Samples: [LM3509](#)

## FEATURES

- Integrated OLED Display Power Supply and LED Driver
- Drives up to 10 LED's at 30mA
- Drives up to 5 LED's at 20mA and Delivers up to 21V at 40mA
- Over 90% Efficient
- 32 Exponential Dimming Steps
- 0.15% Accurate Current Matching Between Strings
- Internal Soft-Start Limits Inrush Current
- True Shutdown Isolation for LED's
- Wide 2.7V to 5.5V Input Voltage Range
- 21V Over-Voltage Protection
- 1.27MHz Fixed Frequency Operation
- Low Profile 10-Pin WSON Package (3mm x 3mm x 0.8mm)
- General Purpose I/O
- Active Low Hardware Reset

## APPLICATIONS

- Dual Display LCD Backlighting for Portable Applications
- Large Format LCD Backlighting
- OLED Panel Power Supply

## DESCRIPTION

The LM3509 current mode boost converter offers two separate outputs. The first output (MAIN) is a constant current sink for driving series white LED's. The second output (SUB/FB) is configurable as a constant current sink for series white LED bias, or as a feedback pin to set a constant output voltage for powering OLED panels.

## Typical Application Circuits

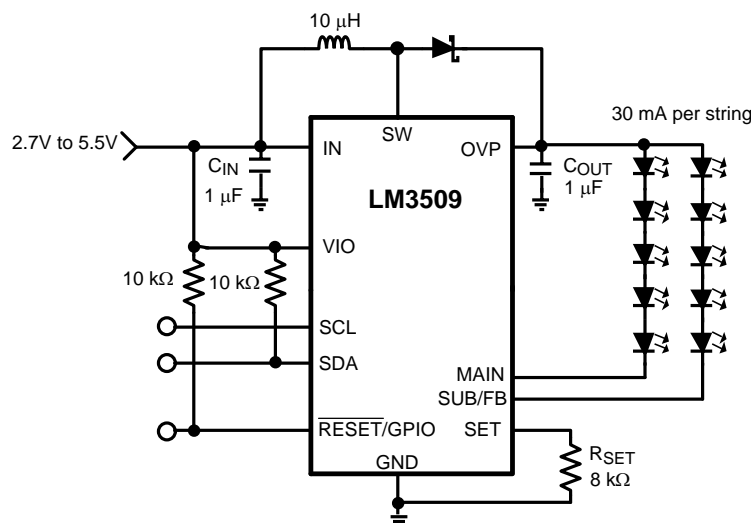

Dual White LED Bias Supply



Please be aware that an important notice concerning availability, standard warranty, and use in critical applications of Texas Instruments semiconductor products and disclaimers thereto appears at the end of this data sheet.

All trademarks are the property of their respective owners.

## DESCRIPTION (CONTINUED)

When configured as a dual output white LED bias supply, the LM3509 adaptively regulates the supply voltage of the LED strings to maximize efficiency and insure the current sinks remain in regulation. The maximum current per output is set via a single external low power resistor. An I<sup>2</sup>C compatible interface allows for independent adjustment of the LED current in either output from 0 to max current in 32 exponential steps. When configured as a white LED + OLED bias supply the LM3509 can independently and simultaneously drive a string of up to 5 white LED's and deliver a constant output voltage of up to 21V for OLED panels.

Output over-voltage protection shuts down the device if V<sub>OUT</sub> rises above 21V allowing for the use of small sized low voltage output capacitors. The LM3509 is offered in a small 10-pin thermally- enhanced WSON package and operates over the -40°C to +85°C temperature range.

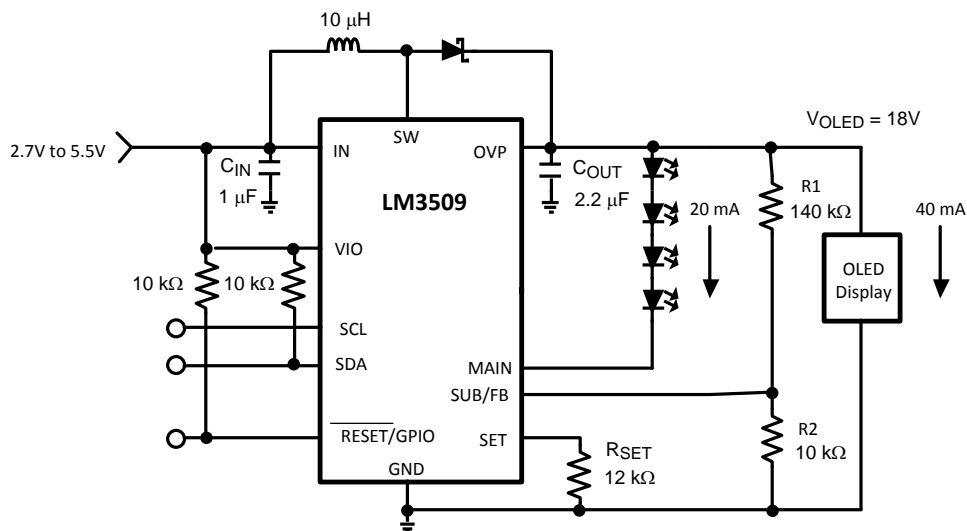

OLED Panel Power Supply

## Connection Diagram

### Top View

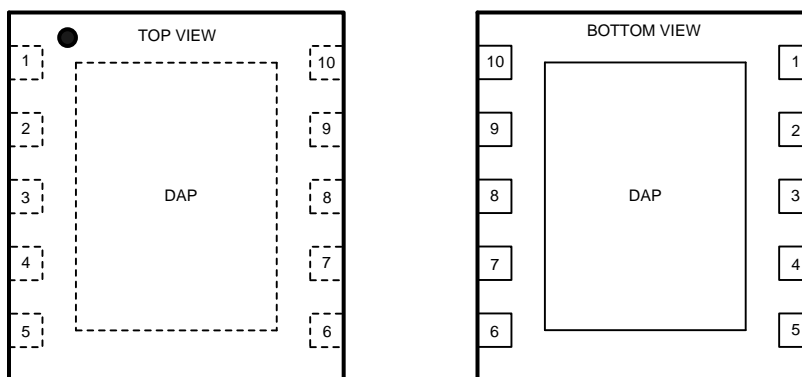

Figure 1. 10-Pin WSON (3mm × 3mm × 0.8mm)

### PIN DESCRIPTIONS

Pin	Name	Function
1	MAIN	Main Current Sink Input.
2	SUB/FB	Secondary Current Sink Input or 1.25V Feedback Connection for Constant Voltage Output.
3	SET	LED Current Setting Connection. Connect a resistor from SET to GND to set the maximum LED current into MAIN or SUB/FB (when in LED mode), where $I_{LED\_MAX} = 192 \times 1.244V/R_{SET}$ .
4	VIO	Logic Voltage Level Input
5	RESET/GPIO	Active Low Hardware Reset and Programmable General Purpose I/O.
6	SW	Drain Connection for Internal NMOS Switch
7	OVP	Over-Voltage Protection Sense Connection. Connect OVP to the positive terminal of the output capacitor.
8	IN	Input Voltage Connection. Connect IN to the input supply, and bypass to GND with a 1µF ceramic capacitor.

### PIN DESCRIPTIONS (continued)

Pin	Name	Function
9	SDA	Serial Data Input/Output
10	SCL	Serial Clock Input
DAP	GND	Ground



These devices have limited built-in ESD protection. The leads should be shorted together or the device placed in conductive foam during storage or handling to prevent electrostatic damage to the MOS gates.

### Absolute Maximum Ratings<sup>(1)(2)(3)</sup>

$V_{IN}$	-0.3V to 6V
$V_{SW}$ , $V_{OVP}$	-0.3V to 25V
$V_{SUB/FB}$ , $V_{MAIN}$	-0.3V to 23V
$V_{SCL}$ , $V_{SDA}$ , $V_{RESET/GPIO}$ , $V_{IO}$ , $V_{SET}$	-0.3V to 6V
Continuous Power Dissipation	Internally Limited
Junction Temperature ( $T_{J-MAX}$ )	+150°C
Storage Temperature Range	-65°C to +150°C
Maximum Lead Temperature (Soldering, 10s) <sup>(4)</sup>	+300°C
ESD Rating <sup>(5)</sup> Human Body Model	2.5kV

- (1) Absolute maximum ratings are limits beyond which damages to the device may occur. Operating Ratings are conditions for which the device is intended to be functional, but device parameter specifications may not be ensured. For ensured specifications and test conditions, see the Electrical Characteristics.
- (2) If Military/Aerospace specified devices are required, please contact the Texas Instrument Sales Office/ Distributors for availability and specifications.
- (3) All voltages are with respect to the potential at the GND pin.
- (4) For detailed soldering specifications and information, please refer to Application Note 1187: Leadless Lead frame Package (AN-1187) (Literature Number [SNOA401](#)).
- (5) The human body model is a 100pF capacitor discharged through 1.5kΩ resistor into each pin. (MIL-STD-883 3015.7).

### Operating Ratings<sup>(1)(2)</sup>

$V_{IN}$	2.7V to 5.5V
$V_{SW}$ , $V_{OVP}$	0V to 23V
$V_{SUB/FB}$ , $V_{MAIN}$	0V to 21V
Junction Temperature Range ( $T_J$ ) <sup>(3)</sup>	-40°C to +110°C
Ambient Temperature Range ( $T_A$ ) <sup>(4)</sup>	-40°C to +85°C

- (1) Absolute maximum ratings are limits beyond which damages to the device may occur. Operating Ratings are conditions for which the device is intended to be functional, but device parameter specifications may not be ensured. For ensured specifications and test conditions, see the Electrical Characteristics.
- (2) All voltages are with respect to the potential at the GND pin.
- (3) Internal thermal shutdown circuitry protects the device from permanent damage. Thermal shutdown engages at  $T_J=150^\circ\text{C}$  (typ.) and disengages at  $T_J=140^\circ\text{C}$  (typ.).
- (4) In applications where high power dissipation and/or poor package thermal resistance is present, the maximum ambient temperature may have to be derated. Maximum ambient temperature ( $T_{A-MAX}$ ) is dependent on the maximum operating junction temperature ( $T_{J-MAX-OP} = +105^\circ\text{C}$ ), the maximum power dissipation of the device in the application ( $P_{D-MAX}$ ), and the junction-to ambient thermal resistance of the part/package in the application ( $\theta_{JA}$ ), as given by the following equation:  $T_{A-MAX} = T_{J-MAX-OP} - (\theta_{JA} \times P_{D-MAX})$ .

### Thermal Properties

Junction to Ambient Thermal Resistance ( $\theta_{JA}$ ) <sup>(1)</sup>	54°C/W
---	--------

- (1) Junction-to-ambient thermal resistance ( $\theta_{JA}$ ) is taken from a thermal modeling result, performed under the conditions and guidelines set forth in the JEDEC standard JESD51-7. The test board is a 4-layer FR-4 board measuring 114mm x 76mm x 1.6mm with a 2x1 array of thermal vias. The ground plane on the board is 113mm x 75mm. Thickness of copper layers are 71.5μm/35μm/35μm/71.5μm (2oz/1oz/1oz/2oz). Ambient temperature in simulation is 22°C, still air. Power dissipation is 1W. The value of  $\theta_{JA}$  of this product in the WSON package could fall in a range as wide as 50°C/W to 150°C/W (if not wider), depending on board material, layout, and environmental conditions. In applications where high maximum power dissipation exists special care must be paid to thermal dissipation issues. For more information on these topics, please refer to Application Note 1187: Leadless Leadframe Package (LLP) (Literature Number [SNOA401](#)).

## Electrical Characteristics

Specifications in standard type face are for  $T_A = 25^\circ\text{C}$  and those in **boldface type** apply over the Operating Temperature Range of  $T_A = -40^\circ\text{C}$  to  $+85^\circ\text{C}$ . Unless otherwise specified  $V_{IN} = 3.6\text{V}$ ,  $V_{IO} = 1.8\text{V}$ ,  $V_{\text{RESET}/\text{GPIO}} = V_{IN}$ ,  $V_{\text{SUB}/\text{FB}} = V_{\text{MAIN}} = 0.5\text{V}$ ,  $R_{\text{SET}} = 12.0\text{k}\Omega$ ,  $\text{OLED} = '0'$ ,  $\text{ENM} = \text{ENS} = '1'$ ,  $\text{BSUB} = \text{BMAIN} = \text{Full Scale}$ .<sup>(1) (2)</sup>

Symbol	Parameter	Conditions	Min	Typ	Max	Units
$I_{\text{LED}}$	Output Current Regulation MAIN or SUB/FB Enabled	$\text{UNI} = '0'$ , or $'1'$	<b>18.6</b>	20	<b>21.8</b>	
	Maximum Current Per Current Sink	$R_{\text{SET}} = 8.0\text{k}\Omega$		30		mA
$I_{\text{LED-MATCH}}$	$I_{\text{MAIN}}$ to $I_{\text{SUB}/\text{FB}}$ Current Matching	$\text{UNI} = '1'$ <sup>(3)</sup>		0.15	<b>1</b>	%
$V_{\text{SET}}$	SET Pin Voltage	$3.0\text{V} < V_{\text{IN}} < 5\text{V}$		1.244		V
$I_{\text{LED}}/I_{\text{SET}}$	$I_{\text{LED}}$ Current to $I_{\text{SET}}$ Current Ratio			192		
$V_{\text{REG\_CS}}$	Regulated Current Sink Headroom Voltage			500		mV
$V_{\text{REG\_OLED}}$	$V_{\text{SUB}/\text{FB}}$ Regulation Voltage in OLED Mode	$3.0\text{V} < V_{\text{IN}} < 5.5\text{V}$ , $\text{OLED} = '1'$	<b>1.172</b>	1.21	<b>1.239</b>	V
$V_{\text{HR}}$	Current Sink Minimum Headroom Voltage	$I_{\text{LED}} = 95\%$ of nominal		300		mV
$R_{\text{DSON}}$	NMOS Switch On Resistance	$I_{\text{SW}} = 100\text{mA}$		0.58		$\Omega$
$I_{\text{CL}}$	NMOS Switch Current Limit	$V_{\text{IN}} = 3.0\text{V}$	<b>650</b>	770	<b>875</b>	mA
$V_{\text{OVP}}$	Output Over-Voltage Protection	ON Threshold	<b>21.2</b>	22	<b>22.9</b>	V
		OFF Threshold	<b>19.7</b>	20.6	<b>21.2</b>	
$f_{\text{SW}}$	Switching Frequency		<b>1.0</b>	1.27	<b>1.4</b>	MHz
$D_{\text{MAX}}$	Maximum Duty Cycle			90		%
$D_{\text{MIN}}$	Minimum Duty Cycle			10		%
$I_{\text{Q}}$	Quiescent Current, Device Not Switching	$V_{\text{MAIN}}$ and $V_{\text{SUB}/\text{FB}} >$ $V_{\text{REG\_CS}}$ , $\text{BSUB} = \text{BMAIN} =$ $0 \times 00$		400	<b>440</b>	$\mu\text{A}$
		$V_{\text{SUB}/\text{FB}} > V_{\text{REG\_OLED}}$ , $\text{OLED} = '1'$ , $\text{ENM} = \text{ENS} = '0'$		250	<b>305</b>	
$I_{\text{SHDN}}$	Shutdown Current	$\text{ENM} = \text{ENS} = \text{OLED} = '0'$		3.6	<b>5</b>	$\mu\text{A}$
<b>RESET/GPIO Pin Voltage Specifications</b>						
$V_{\text{IL}}$	Input Logic Low	$2.7\text{V} < V_{\text{IN}} < 5.5\text{V}$ , $\text{MODE bit} = 0$			<b>0.5</b>	V
$V_{\text{IH}}$	Input Logic High	$2.7\text{V} < V_{\text{IN}} < 5.5\text{V}$ , $\text{MODE bit} = 0$	<b>1.1</b>			V
$V_{\text{OL}}$	Output Logic Low	$I_{\text{LOAD}} = 3\text{mA}$ , $\text{MODE bit} = 1$			<b>400</b>	mV
<b>I<sup>2</sup>C Compatible Voltage Specifications (SCL, SDA, VIO)</b>						
$V_{\text{IO}}$	Serial Bus Voltage Level	$2.7\text{V} < V_{\text{IN}} < 5.5\text{V}$ <sup>(4)</sup>	<b>1.4</b>		$V_{\text{IN}}$	V
$V_{\text{IL}}$	Input Logic Low	$2.7\text{V} < V_{\text{IN}} < 5.5\text{V}$			<b><math>0.36 \times V_{\text{IO}}</math></b>	V
$V_{\text{IH}}$	Input Logic High	$2.7\text{V} < V_{\text{IN}} < 5.5\text{V}$	<b><math>0.7 \times V_{\text{IO}}</math></b>		$V_{\text{IO}}$	V
$V_{\text{OL}}$	Output Logic Low	$I_{\text{LOAD}} = 3\text{mA}$			<b>400</b>	mV
<b>I<sup>2</sup>C Compatible Timing Specifications (SCL, SDA, VIO, see Figure 2)<sup>(5)(4)</sup></b>						
$t_1$	SCL Clock Period		<b>2.5</b>			$\mu\text{s}$
$t_2$	Data In Setup Time to SCL High		<b>100</b>			ns

(1) All voltages are with respect to the potential at the GND pin.

(2) Min and Max limits are specified by design, test, or statistical analysis. Typical (Typ) numbers are not specified, but represent the most likely norm.

(3) The matching specification between MAIN and SUB is calculated as  $100 \times ((I_{\text{MAIN}} \text{ or } I_{\text{SUB}}) - I_{\text{AVE}}) / I_{\text{AVE}}$ . This simplifies out to be  $100 \times (I_{\text{MAIN}} - I_{\text{SUB}}) / (I_{\text{MAIN}} + I_{\text{SUB}})$ .

(4) SCL and SDA signals are referenced to VIO and GND for minimum VIO voltage testing.

(5) SCL and SDA must be glitch-free in order for proper brightness control to be realized.

## Electrical Characteristics (continued)

Specifications in standard type face are for  $T_A = 25^\circ\text{C}$  and those in **boldface type** apply over the Operating Temperature Range of  $T_A = -40^\circ\text{C}$  to  $+85^\circ\text{C}$ . Unless otherwise specified  $V_{IN} = 3.6\text{V}$ ,  $V_{IO} = 1.8\text{V}$ ,  $V_{\text{RESET}/\text{GPIO}} = V_{IN}$ ,  $V_{\text{SUB}/\text{FB}} = V_{\text{MAIN}} = 0.5\text{V}$ ,  $R_{\text{SET}} = 12.0\text{k}\Omega$ ,  $\text{OLED} = '0'$ ,  $\text{ENM} = \text{ENS} = '1'$ ,  $\text{BSUB} = \text{BMAIN} = \text{Full Scale}$ .<sup>(1) (2)</sup>

Symbol	Parameter	Conditions	Min	Typ	Max	Units
$t_3$	Data Out Stable After SCL Low		<b>0</b>			ns
$t_4$	SDA Low Setup Time to SCL Low (Start)		<b>100</b>			ns
$t_5$	SDA High Hold Time After SCL High (Stop)		<b>100</b>			ns

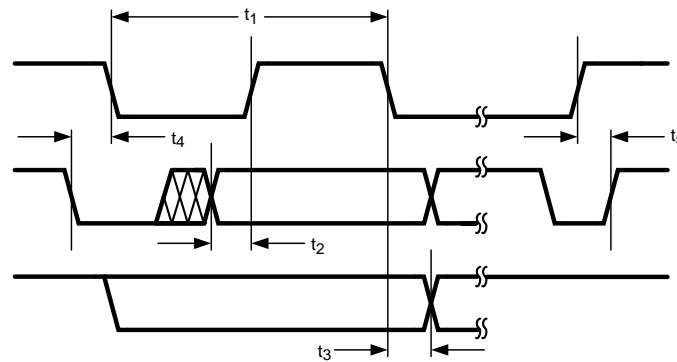

Figure 2. I<sup>2</sup>C Timing

### Typical Performance Characteristics

$V_{IN} = 3.6V$ , LEDs are OSRAM (LW M67C),  $C_{OUT} = 1\mu F$  (LED Mode),  $C_{OUT} = 2.2\mu F$  (OLED Mode),  $C_{IN} = 1\mu F$ ,  $L =$  TDK VLF4012AT-100MR79, ( $R_L = 0.3\Omega$ ),  $R_{SET} = 8.06k\Omega$ ,  $UNI = '1'$ ,  $I_{LED} = I_{SUB} + I_{MAIN}$ ,  $T_A = +25^\circ C$  unless otherwise specified.

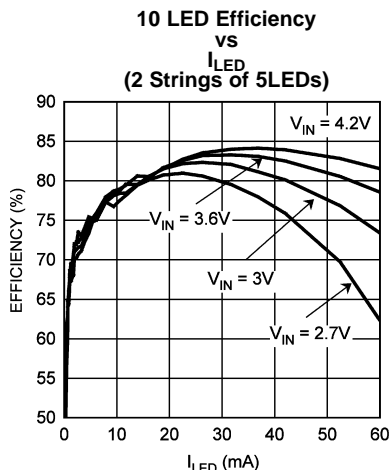

Figure 3.

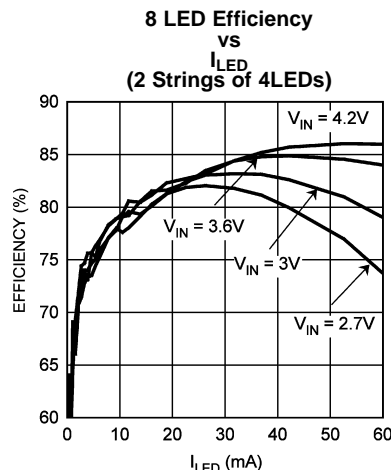

Figure 4.

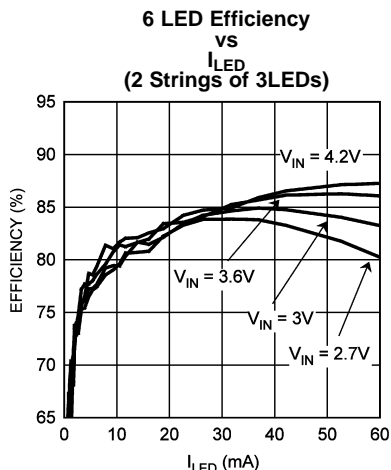

Figure 5.

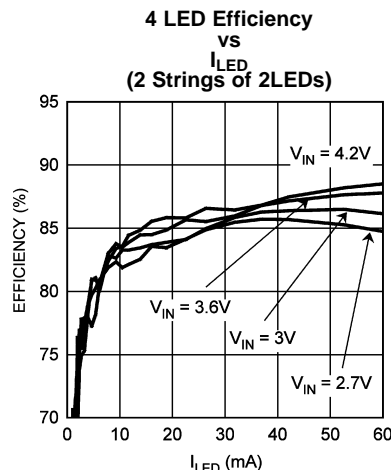

Figure 6.

**LED Efficiency vs  $V_{IN}$**   
( $L =$  TDK VLF3012AT-100MR49,  $R_L = 0.36\Omega$ ,  $I_{LED} = 40mA$ )

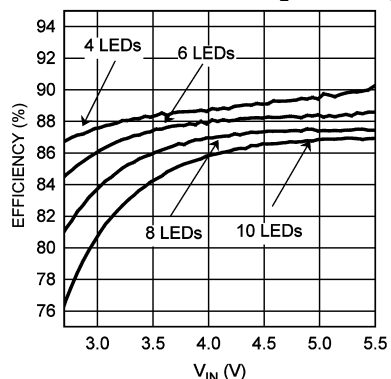

Figure 7.

**LED Efficiency vs  $V_{IN}$**   
( $L =$  TDK VLF5014AT-100MR92,  $R_L = 0.2\Omega$ ,  $I_{LED} = 60mA$ )

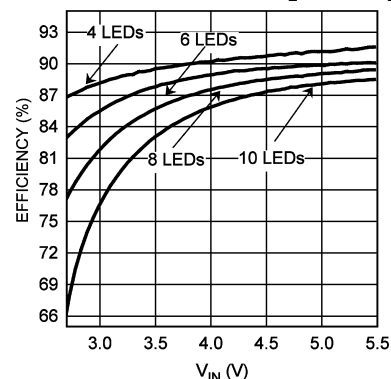

Figure 8.

**Typical Performance Characteristics (continued)**

$V_{IN} = 3.6V$ , LEDs are OSRAM (LW M67C),  $C_{OUT} = 1\mu F$  (LED Mode),  $C_{OUT} = 2.2\mu F$  (OLED Mode),  $C_{IN} = 1\mu F$ ,  $L = TDK$  VLF4012AT-100MR79, ( $R_L = 0.3\Omega$ ),  $R_{SET} = 8.06k\Omega$ ,  $UNI = '1'$ ,  $I_{LED} = I_{SUB} + I_{MAIN}$ ,  $T_A = +25^\circ C$  unless otherwise specified.

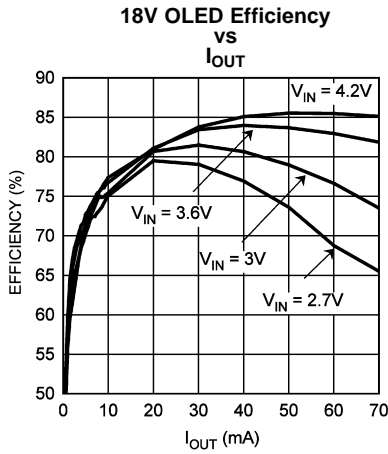

Figure 9.

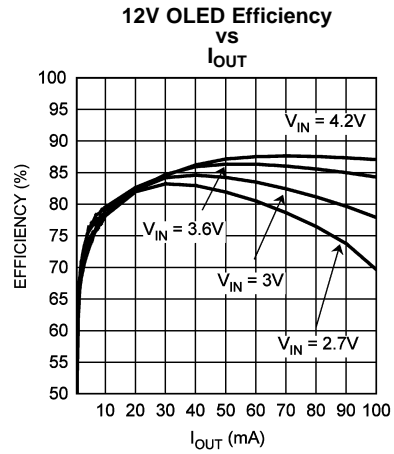

Figure 10.

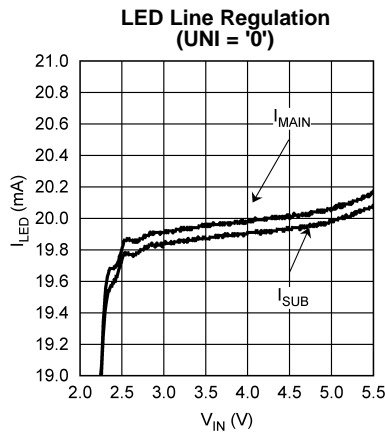

Figure 11.

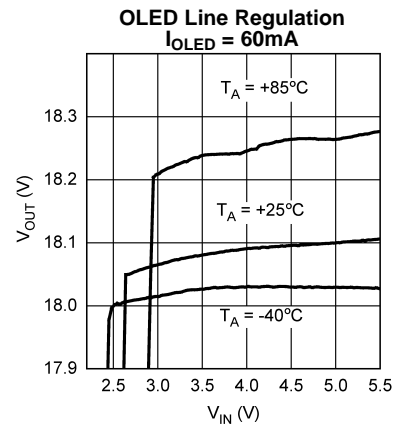

Figure 12.

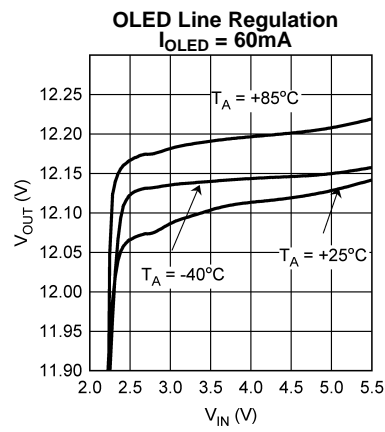

Figure 13.

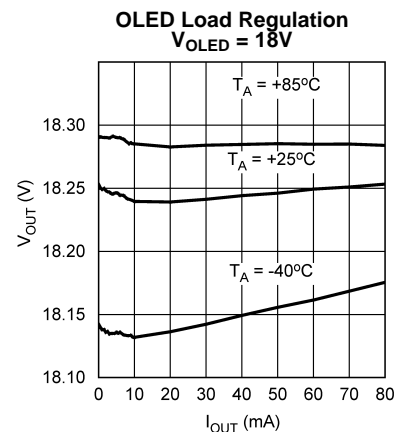

Figure 14.



**Typical Performance Characteristics (continued)**

$V_{IN} = 3.6V$ , LEDs are OSRAM (LW M67C),  $C_{OUT} = 1\mu F$  (LED Mode),  $C_{OUT} = 2.2\mu F$  (OLED Mode),  $C_{IN} = 1\mu F$ ,  $L = TDK$  VLF4012AT-100MR79, ( $R_L = 0.3\Omega$ ),  $R_{SET} = 8.06k\Omega$ ,  $UNI = '1'$ ,  $I_{LED} = I_{SUB} + I_{MAIN}$ ,  $T_A = +25^\circ C$  unless otherwise specified.

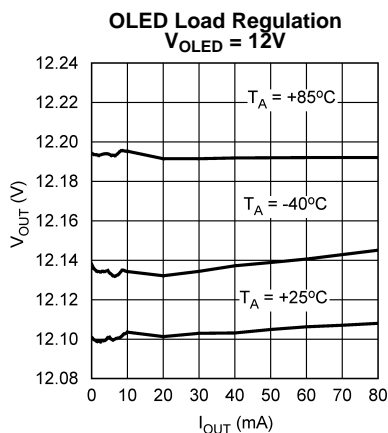

Figure 15.

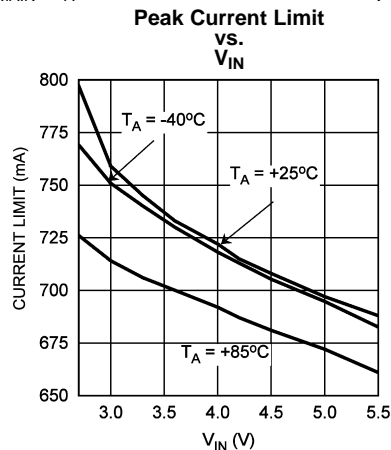

Figure 16.

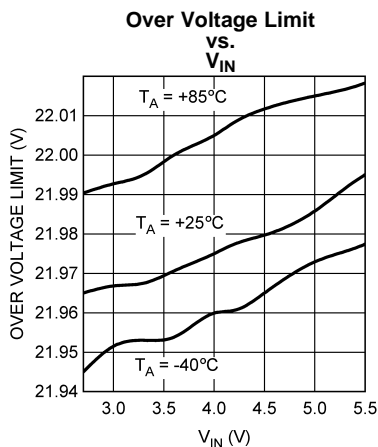

Figure 17.

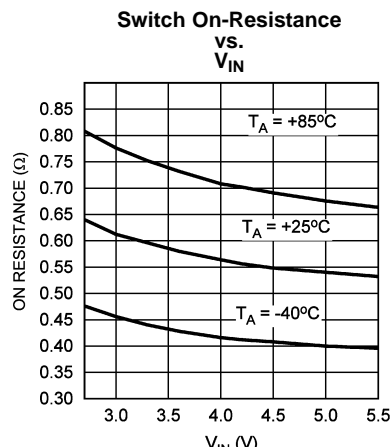

Figure 18.

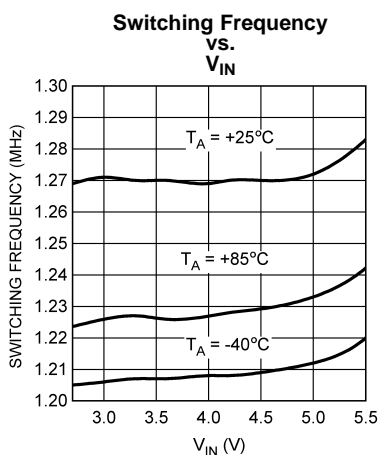

Figure 19.

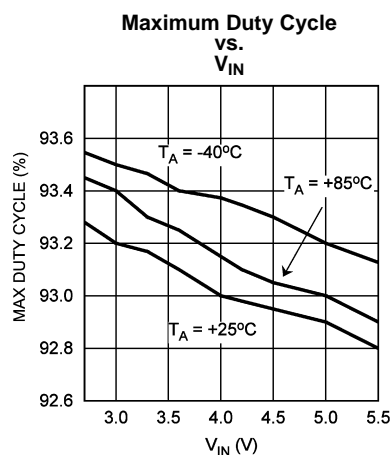

Figure 20.

**Typical Performance Characteristics (continued)**

$V_{IN} = 3.6V$ , LEDs are OSRAM (LW M67C),  $C_{OUT} = 1\mu F$  (LED Mode),  $C_{OUT} = 2.2\mu F$  (OLED Mode),  $C_{IN} = 1\mu F$ ,  $L = TDK$  VLF4012AT-100MR79, ( $R_L = 0.3\Omega$ ),  $R_{SET} = 8.06k\Omega$ ,  $UNI = '1'$ ,  $I_{LED} = I_{SUB} + I_{MAIN}$ ,  $T_A = +25^\circ C$  unless otherwise specified.

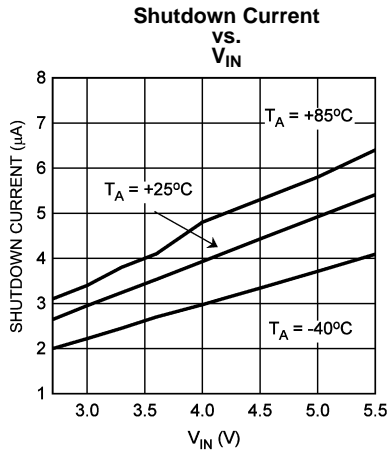

Figure 21.

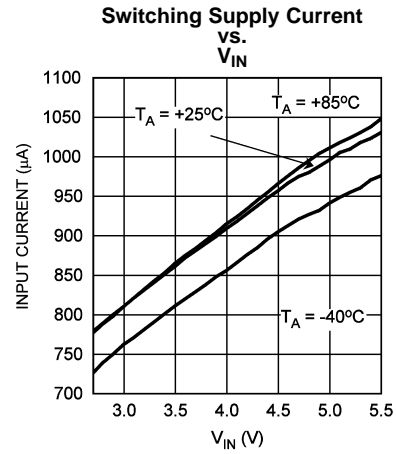

Figure 22.

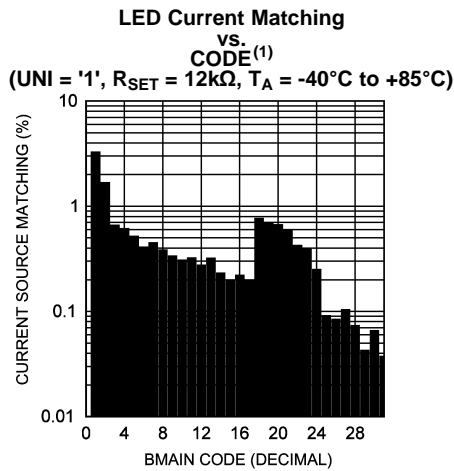

Figure 23.

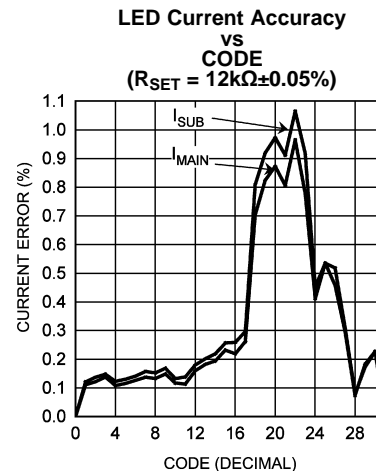

Figure 24.

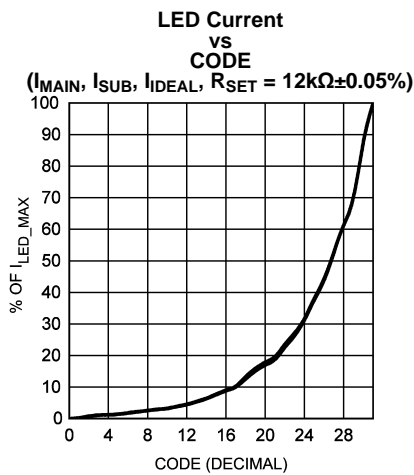

Figure 25.

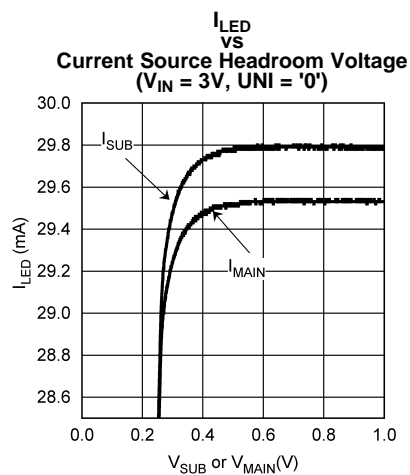

Figure 26.

(1) The matching specification between MAIN and SUB is calculated as  $100 \times ((I_{MAIN} \text{ or } I_{SUB}) - I_{AVE}) / I_{AVE}$ . This simplifies out to be  $100 \times (I_{MAIN} - I_{SUB}) / (I_{MAIN} + I_{SUB})$ .

Typical Performance Characteristics (continued)

$V_{IN} = 3.6V$ , LEDs are OSRAM (LW M67C),  $C_{OUT} = 1\mu F$  (LED Mode),  $C_{OUT} = 2.2\mu F$  (OLED Mode),  $C_{IN} = 1\mu F$ ,  $L = TDK$  VLF4012AT-100MR79, ( $R_L = 0.3\Omega$ ),  $R_{SET} = 8.06k\Omega$ ,  $UNI = '1'$ ,  $I_{LED} = I_{SUB} + I_{MAIN}$ ,  $T_A = +25^\circ C$  unless otherwise specified.

Start-Up Waveform (LED Mode)  
(2 x 5 LEDs, 30mA per string)

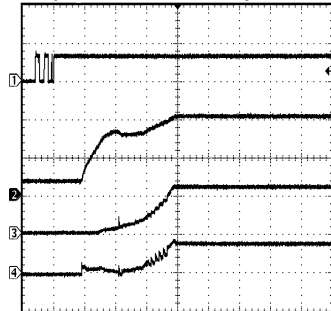

Channel 1: SDA (5V/div)  
Channel 2:  $V_{OUT}$  (10V/div)  
Channel 3:  $I_{LED}$  (50mA/div)  
Channel 4:  $I_{IN}$  (500mA/div)  
Time Base: 400 $\mu s$ /div

Figure 27.

Start-Up Waveform (OLED Mode)  
( $V_{OUT} = 18V$ ,  $I_{OUT} = 60mA$ )

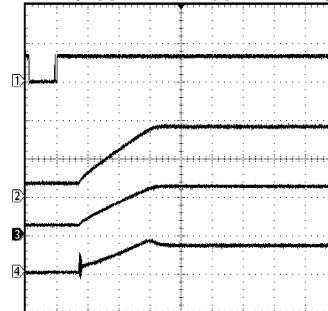

Channel 1: SDA (5V/div)  
Channel 2:  $V_{OUT}$  (10V/div)  
Channel 3:  $I_{OUT}$  (50mA/div)  
Channel 4:  $I_{IN}$  (500mA/div)  
Time Base: 400 $\mu s$ /div

Figure 28.

Load Step (OLED Mode)  
( $V_{OUT} = 18V$ ,  $C_{OUT} = 2.2\mu F$ )

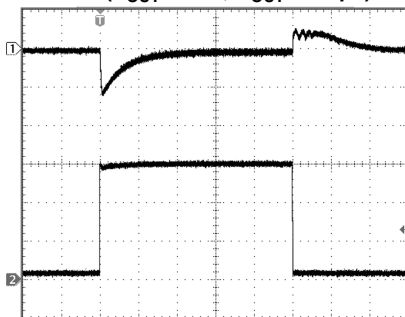

Channel 1:  $V_{OUT}$  (AC Coupled, 500mV/div)  
Channel 2:  $I_{OUT}$  (20mA/div)  
Time Base: 200 $\mu s$ /div

Figure 29.

Line Step (LED Mode)  
(2 x 5 LEDs, 30mA per String,  $C_{OUT} = 1\mu F$ )

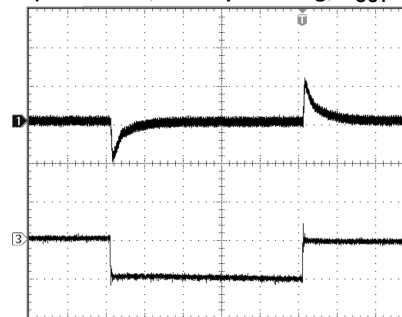

Channel 1:  $V_{OUT}$  (AC Coupled, 500mV/div)  
Channel 2:  $V_{IN}$  (AC Coupled, 500mV/div)  
Time Base: 200 $\mu s$ /div

Figure 30.

Transition From OLED to OLED + 1 x 4 LED  
( $V_{OUT} = 18V$ ,  $I_{OUT} = 40mA$ ,  $I_{LED} = 20mA$ ,  $C_{OUT} = 2.2\mu F$ )

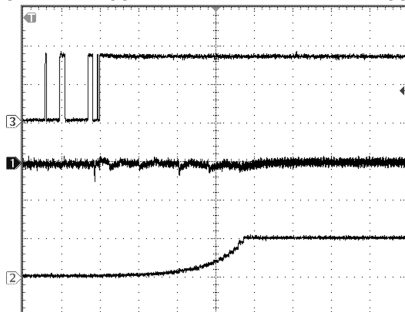

Channel 3: SDA (2V/div)  
Channel 1:  $V_{OUT}$  (AC Coupled, 200mV/div)  
Channel 2:  $I_{MAIN}$  (20mA/div)  
Time Base: 400 $\mu s$ /div

Figure 31.

RESET Functionality

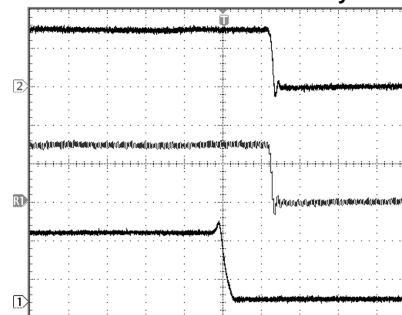

Channel 2:  $I_{SUB}$  (20mA/div)  
Channel R1:  $I_{MAIN}$  (20mA/div)  
Channel 1: RESET (2V/div)  
Time Base: 200ns/div

Figure 32.

**Typical Performance Characteristics (continued)**

$V_{IN} = 3.6V$ , LEDs are OSRAM (LW M67C),  $C_{OUT} = 1\mu F$  (LED Mode),  $C_{OUT} = 2.2\mu F$  (OLED Mode),  $C_{IN} = 1\mu F$ ,  $L = TDK$  VLF4012AT-100MR79, ( $R_L = 0.3\Omega$ ),  $R_{SET} = 8.06k\Omega$ ,  $UNI = '1'$ ,  $I_{LED} = I_{SUB} + I_{MAIN}$ ,  $T_A = +25^\circ C$  unless otherwise specified.

**GPIO Functionality**  
(GPIO Configured as OUTPUT,  $f_{SCL} = 200kHz$ )

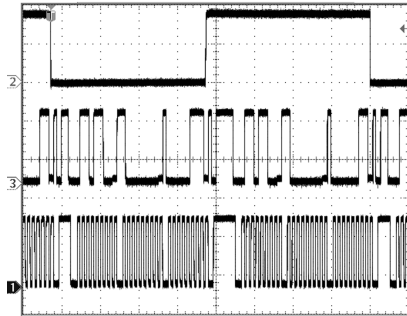

Channel 2: GPIO (2V/div)  
Channel 3: SDA (2V/div)  
Channel 1: SCL (2V/div)  
Time Base: 40µs/div

Figure 33.

**Ramp Rate Functionality**  
(RMP1, RMP0 = '00')

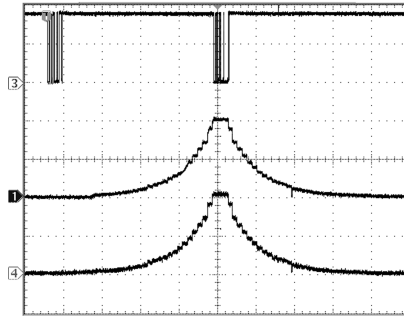

Channel 3: SDA (2V/div)  
Channel 1:  $I_{MAIN}$  (10mA/div)  
Channel 4:  $I_{SUB}$  (10mA/div)  
Time Base: 40µs/div

Figure 34.

**Ramp Rate Functionality**  
(RMP1, RMP0 = '01')

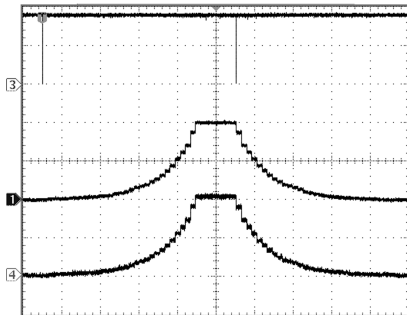

Channel 3: SDA (2V/div)  
Channel 1:  $I_{MAIN}$  (10mA/div)  
Channel 4:  $I_{SUB}$  (10mA/div)  
Time Base: 100ms/div

Figure 35.

**Ramp Rate Functionality**  
(RMP1, RMP0 = '10')

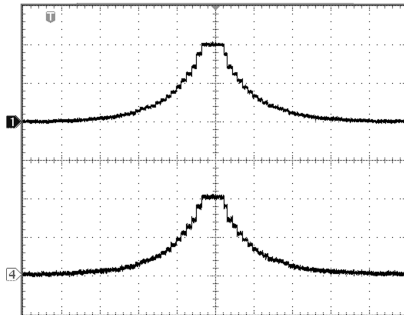

Channel 1:  $I_{MAIN}$  (10mA/div)  
Channel 4:  $I_{SUB}$  (10mA/div)  
Time Base: 200ms/div

Figure 36.

**Ramp Rate Functionality**  
(RMP1, RMP0 = '11')

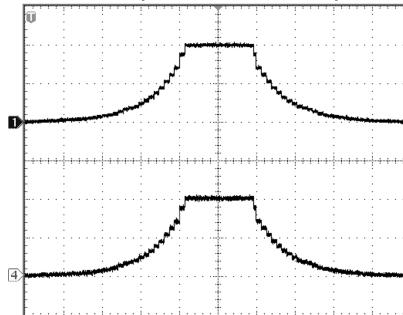

Channel 1:  $I_{MAIN}$  (10mA/div)  
Channel 4:  $I_{SUB}$  (10mA/div)  
Time Base: 400ms/div

Figure 37.

**BLOCK DIAGRAM**

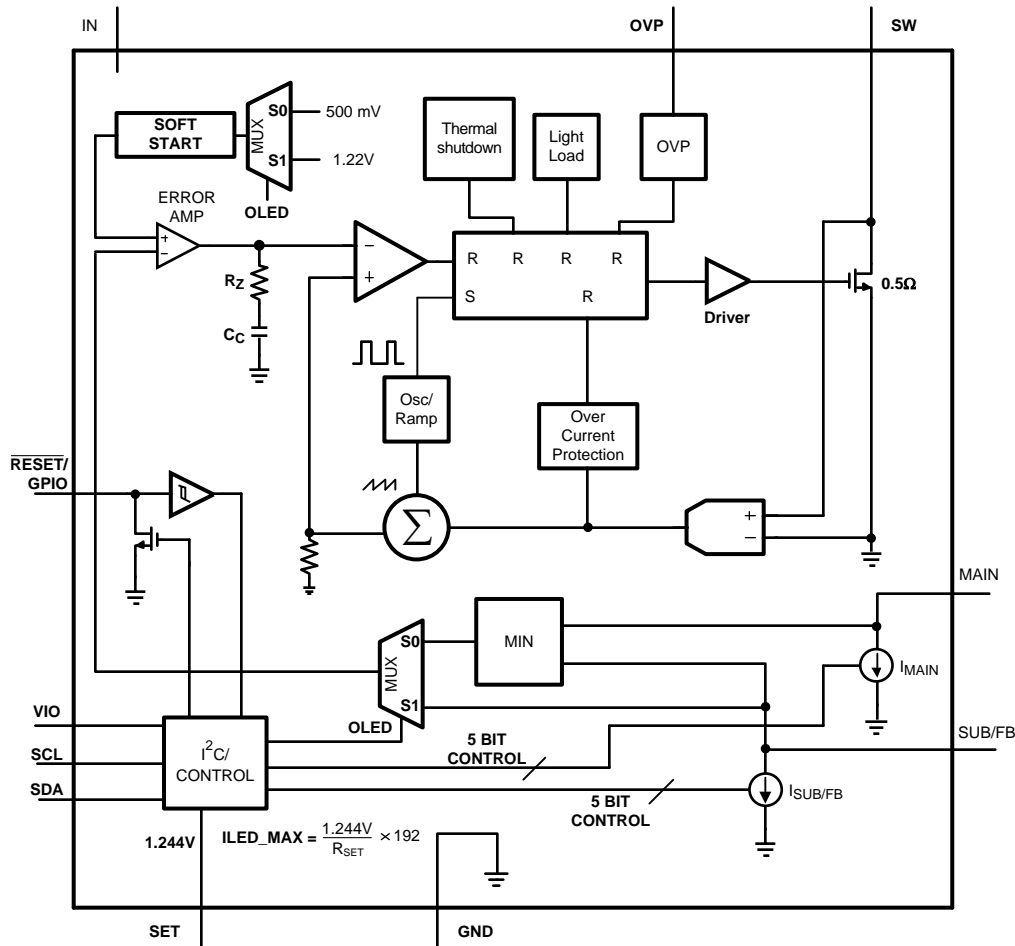

**Figure 38. LM3509 Block Diagram**

**OPERATION DESCRIPTION**

The LM3509 Current Mode PWM boost converter operates from a 2.7V to 5.5V input and provides two regulated outputs for White LED and OLED display biasing. The first output, MAIN, provides a constant current of up to 30mA to bias up to 5 series white LED's. The second output, SUB/FB, can be configured as a current source for up to 5 series white LED's at 30mA, or as a feedback voltage pin to regulate a constant output voltage of up to 21V. When both MAIN and SUB/FB are configured for white LED bias the current for each LED string is controlled independently or in unison via an I<sup>2</sup>C compatible interface. When MAIN is configured for white LED bias and SUB/FB is configured as a feedback voltage pin, the current into MAIN is controlled via the I<sup>2</sup>C compatible interface and SUB/FB becomes the middle tap of a resistive divider used to regulate the output voltage of the boost converter.

The core of the LM3509 is a Current Mode Boost converter. Operation is as follows. At the start of each switching cycle the internal oscillator sets the PWM converter. The converter turns the NMOS switch on, allowing the inductor current to ramp while the output capacitor supplies power to the white LED's and/or OLED panel. The error signal at the output of the error amplifier is compared against the sensed inductor current. When the sensed inductor current equals the error signal, or when the maximum duty cycle is reached, the NMOS switch turns off causing the external Schottky diode to pick up the inductor current. This allows the inductor current to ramp down causing its stored energy to charge the output capacitor and supply power to the load. At the end of the clock period the PWM controller is again set and the process repeats itself.

## Adaptive Regulation

When biasing dual white led strings (White LED mode) the LM3509 maximizes efficiency by adaptively regulating the output voltage. In this configuration the 500mV reference is connected to the non-inverting input of the error amplifier via mux S2 (see [Figure 38](#)). The lowest of either  $V_{MAIN}$  or  $V_{SUB/FB}$  is then applied to the inverting input of the error amplifier via mux S1. This ensures that  $V_{MAIN}$  and  $V_{SUB/FB}$  are at least 500mV, thus providing enough voltage headroom at the input to the current sinks for proper current regulation.

In the instance when there are unequal numbers of LEDs or unequal currents from string to string, the string with the highest voltage will be the regulation point.

## Unison/Non-Unison Mode

Within White LED mode there are two separate modes of operation, Unison and Non-Unison. Non-Unison mode provides for independent current regulation, while Unison mode gives up independent regulation for more accurate matching between LED strings. When in Non-Unison mode the LED currents  $I_{MAIN}$  and  $I_{SUB/FB}$  are independently controlled via registers BMAIN and BSUB respectively (see [Brightness Registers \(BMAIN and BSUB\)](#) section). When in Unison mode BSUB is disabled and both  $I_{MAIN}$  and  $I_{SUB/FB}$  are controlled via BMAIN only.

## Start-Up

The LM3509 features an internal soft-start, preventing large inrush currents during start-up that can cause excessive voltage ripple on the input. For the typical application circuits when the device is brought out of shutdown the average input current ramps from zero to 450mA in 1.2ms. See Start Up Plots in the [Typical Performance Characteristics](#).

## OLED Mode

When the LM3509 is configured for a single White LED bias + OLED display bias (OLED mode), the non-inverting input of the error amplifier is connected to the internal 1.21V reference via MUX S2. MUX S1 switches SUB/FB to the inverting input of the error amplifier while disconnecting the internal current sink at SUB/FB. The voltage at MAIN is not regulated in OLED mode so when the application requires white LED + OLED panel biasing, ensure that at least 300mV of headroom is maintained at MAIN to guarantee proper regulation of  $I_{MAIN}$ . (see the [Typical Performance Characteristics](#) for a plot of  $I_{LED}$  vs Current Source Headroom Voltage)

## Peak Current Limit

The LM3509's boost converter has a peak current limit for the internal power switch of 770mA typical (650mA minimum). When the peak switch current reaches the current limit the duty cycle is terminated resulting in a limit on the maximum output current and thus the maximum output power the LM3509 can deliver. Calculate the maximum LED current as a function of  $V_{IN}$ ,  $V_{OUT}$ , L and  $I_{PEAK}$  as:

$$I_{OUT\_MAX} = \frac{(I_{PEAK} - \Delta I_L) \times \eta \times V_{IN}}{V_{OUT}}$$

$$\text{where } \Delta I_L = \frac{V_{IN} \times (V_{OUT} - V_{IN})}{2 \times f_{SW} \times L \times V_{OUT}}$$

(1)

$f_{SW} = 1.27\text{MHz}$ . Typical values for efficiency and  $I_{PEAK}$  can be found in the efficiency and  $I_{PEAK}$  curves in the [Typical Performance Characteristics](#).

## Over Voltage Protection

The LM3509's output voltage ( $V_{OUT}$ ) is limited on the high end by the Output Over-Voltage Protection Threshold ( $V_{OVP}$ ) of 21.2V. In White LED mode during output open circuit conditions the output voltage will rise to the over voltage protection threshold ( $V_{OVP} = 21.2\text{V min}$ ). When this happens the controller will stop switching causing  $V_{OUT}$  to droop. When the output voltage drops below 19.7V (min) the device will resume switching. If the device remains in an over voltage condition the LM3509 will repeat the cycle causing the output to cycle between the high and low OVP thresholds. See waveform for OVP condition in the [Typical Performance Characteristics](#).

## Output Current Accuracy and Current Matching

The LM3509 provides both precise current accuracy (% error from ideal value) and accurate current matching between the MAIN and SUB/FB current sinks. Two modes of operation affect the current matching between  $I_{MAIN}$  and  $I_{SUB/FB}$ . The first mode (Non-Unison mode) is set by writing a 0 to bit 2 of the General Purpose register (UNI bit). Non-Unison mode allows for independent programming of  $I_{MAIN}$  and  $I_{SUB/FB}$  via registers BMAIN and BSUB respectively. In this mode typical matching between current sinks is 1%.

Writing a 1 to UNI configures the device for Unison mode. In Unison mode, BSUB is disabled and  $I_{MAIN}$  and  $I_{SUB/FB}$  are both controlled via register BMAIN. In this mode typical matching is 0.15%.

## Light Load Operation

The LM3509 boost converter operates in three modes; continuous conduction, discontinuous conduction, and skip mode operation. Under heavy loads when the inductor current does not reach zero before the end of the switching period the device switches at a constant frequency. As the output current decreases and the inductor current reaches zero before the end of the switching cycle, the device operates in discontinuous conduction. At very light loads the LM3509 will enter skip mode operation causing the switching period to lengthen and the device to only switch as required to maintain regulation at the output.

## Active Low Reset/General Purpose I/O ( $\overline{RESET}/GPIO$ )

The  $\overline{RESET}/GPIO$  serves as an active low reset input or as a general-purpose logic input/output. Upon power-up of the device  $\overline{RESET}/GPIO$  defaults to the active low reset mode. The functionality of  $\overline{RESET}/GPIO$  is set via the GPIO register and is detailed in Table 6. When configured as an active low reset input, (Bit 0 = 0), pulling  $\overline{RESET}/GPIO$  low automatically programs all registers of the LM3509 with 0x00. Their state cannot be changed until  $\overline{RESET}/GPIO$  is pulled high. The General Purpose I/O (GPIO) register is used to enable the GPIO function of the  $\overline{RESET}/GPIO$  pin. The GPIO register is an 8-bit register with only the 3 LSB's active. The 5 MSB's are not used. When configured as an output,  $\overline{RESET}/GPIO$  is open drain and requires an external pull-up resistor.

## Thermal Shutdown

The LM3509 offers a thermal shutdown protection. When the die temperature reaches +140°C the device will shutdown and not turn on again until the die temperature falls below +120°C.

## I<sup>2</sup>C Compatible Interface

The LM3509 is controlled via an I<sup>2</sup>C compatible interface. START and STOP conditions classify the beginning and the end of the I<sup>2</sup>C session. A START condition is defined as SDA transitioning from HIGH to LOW while SCL is HIGH. A STOP condition is defined as SDA transitioning from LOW to HIGH while SCL is HIGH. The I<sup>2</sup>C master always generates START and STOP conditions. The I<sup>2</sup>C bus is considered busy after a START condition and free after a STOP condition. During data transmission, the I<sup>2</sup>C master can generate repeated START conditions. A START and a repeated START conditions are equivalent function-wise. The data on SDA must be stable during the HIGH period of the clock signal (SCL). In other words, the state of SDA can only be changed when SCL is LOW.

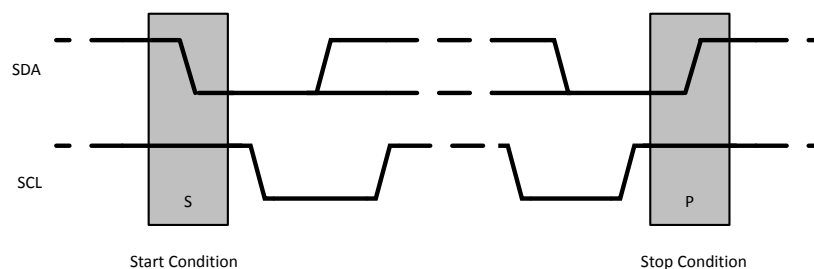
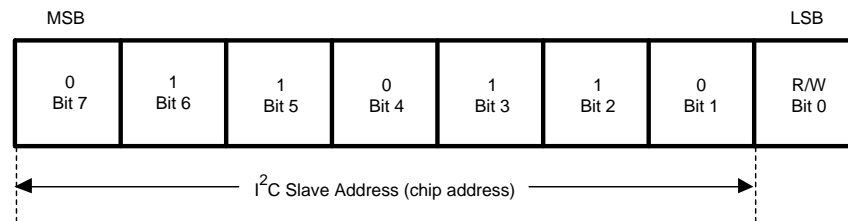

Figure 39. Start and Stop Sequences

## I<sup>2</sup>C Compatible Address

The chip address for the LM3509 is 0110110 (36h). After the START condition, the I<sup>2</sup>C master sends the 7-bit chip address followed by a read or write bit (R/W). R/W = 0 indicates a WRITE and R/W = 1 indicates a READ. The second byte following the chip address selects the register address to which the data will be written. The third byte contains the data for the selected register.



**Figure 40. Chip Address**

## Transferring Data

Every byte on the SDA line must be eight bits long, with the most significant bit (MSB) transferred first. Each byte of data must be followed by an acknowledge bit (ACK). The acknowledge related clock pulse (9th clock pulse) is generated by the master. The master releases SDA (HIGH) during the 9th clock pulse. The LM3509 pulls down SDA during the 9th clock pulse, signifying an acknowledge. An acknowledge is generated after each byte has been received. [Figure 41](#) is an example of a write sequence to the General Purpose register of the LM3509.

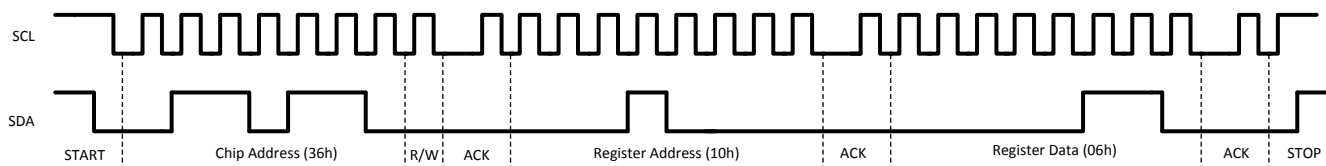

**Figure 41. Write Sequence to the LM3509**

## Register Descriptions

There are 4, 8 bit registers within the LM3509 as detailed in [Table 1](#).

**Table 1. LM3509 Register Descriptions**

Register Name	Hex Address	Power -On-Value
General Purpose (GP)	10	0xC0
Brightness Main (BMAIN)	A0	0xE0
Brightness Sub (BSUB)	B0	0xE0
General Purpose I/O (GPIO)	80	0XF8

## General Purpose Register (GP)

The General Purpose register has four functions. It controls the on/off state of MAIN and SUB/FB, it selects between Unison or Non-Unison mode, provides for control over the rate of change of the LED current (see [Brightness Rate of Change Description](#)), and selects between White LED and OLED mode. [Figure 42](#) and [Table 2](#) describes each bit available within the General Purpose Register.

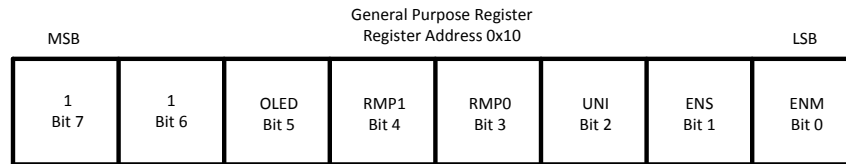

**Figure 42. General Purpose Register Description**
**Table 2. General Purpose Register Bit Function**

Bit	Name	Function	Power-On-Value
0	ENM	Enable MAIN. Writing a 1 to this bit enables the main current sink (MAIN). Writing a 0 to this bit disables the main current sink and forces MAIN high impedance.	0
1	ENS	Enable SUB/FB. Writing a 1 to this bit enables the secondary current sink (SUB/FB). Writing a 0 to this bit disables the secondary current sink and forces SUB/FB high impedance.	0
2	UNI	Unison Mode Select. Writing a 1 to this bit disables the BSUB register and causes the contents of BMAIN to set the current in both the MAIN and SUB/FB current sinks. Writing a 0 to this bit allows the current into MAIN and SUB/FB to be independently controlled via the BMAIN and BSUB registers respectively.	0
3	RMP0	Brightness Rate of Change. Bits RMP0 and RMP1 set the rate of change of the LED current into MAIN and SUB/FB in response to changes in the contents of registers BMAIN and BSUB (see <a href="#">Brightness Rate of Change Description</a> ).	0
4	RMP1		0
5	OLED	OLED = 0 places the LM3509 in White LED mode. In this mode both the MAIN and SUB/FB current sinks are active. The boost converter ensures there is at least 500mV at $V_{MAIN}$ and $V_{SUB/FB}$ . OLED = 1 places the LM3509 in OLED mode. In this mode the boost converter regulates $V_{SUB/FB}$ to 1.25V. $V_{MAIN}$ is unregulated and must be > 400mV for the MAIN current sink to maintain current regulation.	0
6	Don't Care	These are non-functional read only bits. They will always read back as a 1.	1
7			

**Table 3. Operational Truth Table**

UNI	OLED	ENM	ENS	Result
X	0	0	0	LM3509 Disabled
1	0	1	X	MAIN and SUB/FB current sinks enabled. Current levels set by contents of BMAIN.
1	0	0	X	MAIN and SUB/FB Disabled
0	0	0	1	SUB/FB current sink enabled. Current level set by BSUB.
0	0	1	0	MAIN current sink enabled. Current level set by BMAIN.
0	0	1	1	MAIN and SUB/FB current sinks enabled. Current levels set by contents of BMAIN and BSUB respectively.
X	1	1	X	SUB/FB current sink disabled (SUB/FB configured as a feedback pin). MAIN current sink enabled current level set by BMAIN.
X	1	0	X	SUB/FB current sink disabled (SUB/FB configured as a feedback pin). MAIN current sink disabled.

\* ENM ,ENS, or OLED high enables analog circuitry.

### Brightness Registers (BMAIN and BSUB)

With the UNI bit (General Purpose register) set to 0 (Non-Unison mode) both brightness registers (BMAIN and BSUB) independently control the LED currents  $I_{MAIN}$  and  $I_{SUB/FB}$  respectively. BMAIN and BSUB are both 8 bit, but with only the 5 LSB's controlling the current. The three MSB's are don't cares. The LED current control is designed to approximate an exponentially increasing response of the LED current vs increasing code in either BMAIN or BSUB (see [Figure 45](#)). Program  $I_{LED\_MAX}$  by connecting a resistor (RSET) from SET to GND, where:

$$I_{LED\_MAX} = 192 \times \frac{1.244V}{R_{SET}} \quad (2)$$

With the UNI bit (General Purpose register) set to 1 (Unison mode), BSUB is disabled and BMAIN sets both  $I_{MAIN}$  and  $I_{SUB/FB}$ . This prevents the independent control of  $I_{MAIN}$  and  $I_{SUB/FB}$ , however matching between current sinks goes from typically 1% (with UNI = 0) to typically 0.15% (with UNI = 1). Figure 43 and Figure 44 show the register descriptions for the Brightness MAIN and Brightness SUB registers. Table 4 and Figure 45 show  $I_{MAIN}$  and/or  $I_{SUB/FB}$  vs. brightness data as a percentage of  $I_{LED\_MAX}$ .

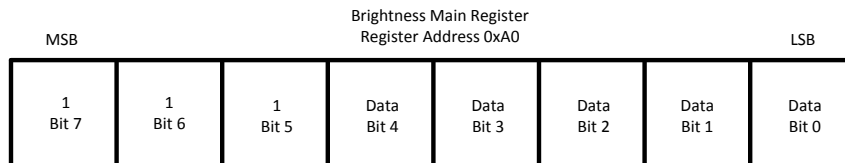

**Figure 43. Brightness MAIN Register Description**

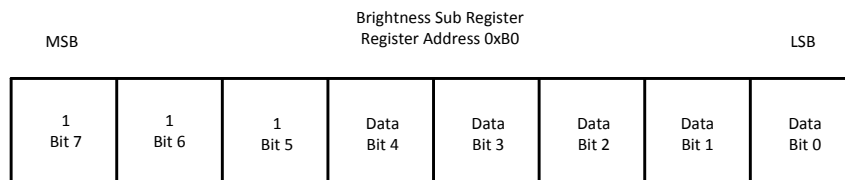

**Figure 44. Brightness SUB Register Description**

**Table 4.  $I_{LED}$  vs. Brightness Register Data**

BMAIN or BSUB Brightness Data	% of ILED_MAX	BMAIN or BSUB Brightness Data	% of ILED_MAX
00000	0.000%	10000	8.750%
00001	0.125%	10001	10.000%
00010	0.625%	10010	12.500%
00011	1.000%	10011	15.000%
00100	1.125%	10100	16.875%
00101	1.313%	10101	18.750%
00110	1.688%	10110	22.500%
00111	2.063%	10111	26.250%
01000	2.438%	11000	31.250%
01001	2.813%	11001	37.500%
01010	3.125%	11010	43.750%
01011	3.750%	11011	52.500%
01100	4.375%	11100	61.250%
01101	5.250%	11101	70.000%
01110	6.250%	11110	87.500%
01111	7.500%	11111	100.000%

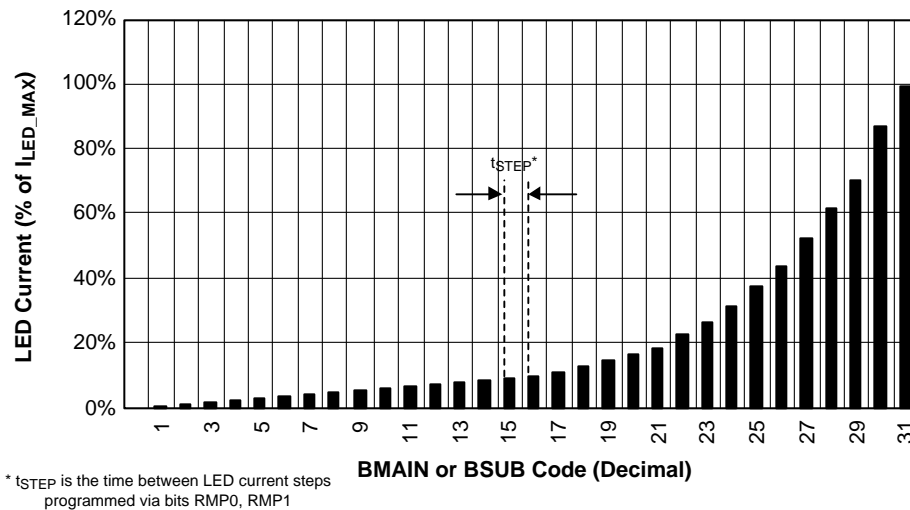

Figure 45. I<sub>MAIN</sub> or I<sub>SUB</sub> vs BMAIN or BSUB Data

### Brightness Rate of Change Description

RMP0 and RMP1 control the rate of change of the LED current I<sub>MAIN</sub> and I<sub>SUB/FB</sub> in response to changes in BMAIN and /or BSUB. There are 4 user programmable LED current rates of change settings for the LM3509 (see Table 5).

Table 5. Rate of Change Bits

RMP0	RMP1	Change Rate (t <sub>STEP</sub> )
0	0	51µs/step
0	1	13ms/step
1	0	26ms/step
1	1	52ms/step

For example, if R<sub>SET</sub> = 12kΩ then I<sub>LED\_MAX</sub> = 20mA. With the contents of BMAIN set to 0x1F (I<sub>MAIN</sub> = 20mA), suppose the contents of BMAIN are changed to 0x00 resulting in (I<sub>MAIN</sub> = 0mA). With RMP0 = 1 and RMP1 = 1 (52ms/step), I<sub>MAIN</sub> will change from 20mA to 0mA in 31 steps with 52ms elapsing between steps, excluding the step from 0x1F to 0x1E, resulting in a full scale current change in 1560ms. The total time to transition from one brightness code to another is:

$$t_{\text{transition}} = (|\text{InitialCode} - \text{FinalCode}| - 1) \times t_{\text{STEP}} \tag{3}$$

The following 3 additional examples detail possible scenarios when using the brightness register in conjunction with the rate of change bits and the enable bits.

#### Example 1:

Step 1: Write to BMAIN a value corresponding to I<sub>MAIN</sub> = 20mA.

Step 2: Write 1 to ENM (turning on MAIN)

Step 3: I<sub>MAIN</sub> ramps to 20mA with a rate set by RMP0 and RMP1. (RMP0 and RMP1 bits set the duration spent at one brightness code before incrementing to the next).

Step 4: ENM is set to 0 before 20mA is reached, thus the LED current fades off at a rate given by RMP0 and RMP1 without I<sub>MAIN</sub> going up to 20mA.

**Example 2:**

Step 1: ENM is 1, and BMAIN has been programmed with code 0x01. This results in a small current into MAIN.

Step 2: BMAIN is programmed with 0x1F (full scale current). This causes  $I_{MAIN}$  to ramp toward full-scale at the rate selected by RMP0 and RMP1.

Step 3: Before  $I_{MAIN}$  reaches full-scale BMAIN is programmed with 0x09.  $I_{MAIN}$  will continue to ramp to full scale.

Step 4: When  $I_{MAIN}$  has reached full-scale value it will ramp down to the current corresponding to 0x09 at a rate set by RMP0 and RMP1.

**Example 3:**

Step 1: Write to BMAIN a value corresponding to  $I_{MAIN} = 20\text{mA}$ .

Step 2: Write a 1 to both RMP0 and RMP1.

Step 3: Write 1 to ENM (turning on MAIN).

Step 4:  $I_{MAIN}$  ramps toward 20mA with a rate set by RMP0 and RMP1. (RMP0 and RMP1 bits set the duration spent at one brightness code before incrementing to the next).

Step 5: After 1.04s  $I_{MAIN}$  has ramped to 16.875% of  $I_{LED\_MAX}$  ( $0.16875 \times 20\text{mA} = 3.375\text{mA}$ ). Simultaneously, RMP0 and RMP1 are both programmed with 0.

Step 6:  $I_{MAIN}$  continues ramping from 3.375mA to 20mA, but at a new ramp rate of 51 $\mu\text{s}/\text{step}$ .

**Table 6. GPIO Register Function**

Bits 7 – 3	Data (Bit 2)	Mode (Bit 1)	Enable GPIO (Bit 0)	Function
X	X	X	0	$\overline{\text{RESET}}$ /GPIO is configured as an active low reset input. This is the default power on state.
X	Logic Input	0	1	$\overline{\text{RESET}}$ /GPIO is configured as a logic input. The logic level applied to $\overline{\text{RESET}}$ /GPIO can be read via bit 2 of the GPIO register.
X	Logic Output	1	1	$\overline{\text{RESET}}$ /GPIO is configured as a logic output. A 0 in bit 2 forces $\overline{\text{RESET}}$ /GPIO low. A 1 in bit 2 forces $\overline{\text{RESET}}$ /GPIO high impedance.

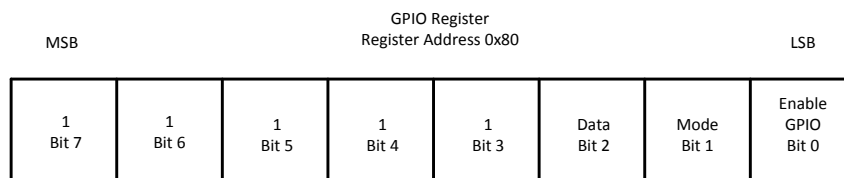
**Figure 46. GPIO Register Description****Shutdown and Output Isolation**

The LM3509 provides a true shutdown for either MAIN or SUB/FB when configured as a White LED bias supply. Write a 0 to ENM (bit 1) of the General Purpose register to turn off the MAIN current sink and force MAIN high impedance. Write a 0 to ENS (bit 2) of the General Purpose register to turn off the SUB/FB current sink and force SUB/FB high impedance. Writing a 1 to ENM or ENS turns on the MAIN and SUB/FB current sinks respectively. When in shutdown the leakage current into MAIN or SUB/FB is typically 3.6 $\mu\text{A}$ . See [Typical Performance Characteristics](#) Plots for start-up responses of the LM3509 using the ENM and ENS bits in White LED and OLED modes.

**Application Information****LED Current Setting/Maximum LED Current**

Connect a resistor ( $R_{SET}$ ) from SET to GND to program the maximum LED current ( $I_{LED\_MAX}$ ) into MAIN or SUB/FB. The  $R_{SET}$  to  $I_{LED\_MAX}$  relationship is:

$$I_{LED\_MAX} = 192 \times \frac{1.244V}{R_{SET}} \quad (4)$$

where SET provides the constant 1.244V output.

### Output Voltage Setting (OLED Mode)

Connect Feedback resistors from the converters output to SUB/FB to GND to set the output voltage in OLED mode (see R1 and R2 in the [Typical Application Circuits](#) (OLED Panel Power Supply). First select R2 < 100kΩ then calculate R1 such that:

$$R1 = R2 \left( \frac{V_{OUT}}{1.21V} - 1 \right) \quad (5)$$

In OLED mode the MAIN current sink continues to regulate the current through MAIN, however,  $V_{MAIN}$  is no longer regulated. To avoid dropout and ensure proper current regulation the application must ensure that  $V_{MAIN} > 0.3V$ .

### Input Capacitor Selection

Choosing the correct size and type of input capacitor helps minimize the input voltage ripple caused by the switching of the LM3509's boost converter. For continuous inductor current operation the input voltage ripple is composed of 2 primary components, the capacitor discharge ( $\Delta V_Q$ ) and the capacitor's equivalent series resistance ( $\Delta V_{ESR}$ ). These ripple components are found by:

$$\Delta V_Q = \frac{\Delta I_L \times D}{2 \times f_{SW} \times C_{IN}}$$

and

$$\Delta V_{ESR} = 2 \times \Delta I_L \times R_{ESR}$$

$$\text{where } \Delta I_L = \frac{V_{IN} \times (V_{OUT} - V_{IN})}{2 \times f_{SW} \times L \times V_{OUT}} \quad (6)$$

In the typical application circuit a 1μF ceramic input capacitor works well. Since the ESR in ceramic capacitors is typically less than 5mΩ and the capacitance value is usually small, the input voltage ripple is primarily due to the capacitive discharge. With larger value capacitors such as tantalum or aluminum electrolytic the ESR can be greater than 0.5Ω. In this case the input ripple will primarily be due to the ESR.

### Output Capacitor Selection

The LM3509's output capacitor supplies the LED current during the boost converters on time. When the switch turns off the inductor energy is discharged through the diode supplying power to the LED's and restoring charge to the output capacitor. This causes a sag in the output voltage during the on time and a rise in the output voltage during the off time. The output capacitor is therefore chosen to limit the output ripple to an acceptable level depending on LED or OLED panel current requirements and input/output voltage differentials. For proper operation ceramic output capacitors ranging from 1μF to 2.2μF are required.

As with the input capacitor, the output voltage ripple is composed of two parts, the ripple due to capacitor discharge ( $\Delta V_Q$ ) and the ripple due to the capacitors ESR ( $\Delta V_{ESR}$ ). For continuous conduction mode, the ripple components are found by:

$$\Delta V_Q = \frac{I_{LED} \times (V_{OUT} - V_{IN})}{f_{SW} \times V_{OUT} \times C_{OUT}} \quad \text{and}$$

$$\Delta V_{ESR} = R_{ESR} \times \left( \frac{I_{LED} \times V_{OUT}}{V_{IN}} + \Delta I_L \right)$$

where 
$$\Delta I_L = \frac{V_{IN} \times (V_{OUT} - V_{IN})}{2 \times f_{SW} \times L \times V_{OUT}}$$

(7)

Table 7 lists different manufacturers for various capacitors and their case sizes that are suitable for use with the LM3509. When configured as a dual output LED driver a 1µF output capacitor is adequate. In OLED mode for output voltages above 12V a 2.2µF output capacitor is required.

**Table 7. Recommended Output Capacitors**

Manufacturer	Part Number	Value	Case Size	Voltage Rating
TDK	C1608X5R1E105M	1µF	0603	25V
Murata	GRM39X5R105K25D539	1µF	0603	25V
TDK	C2012X5R1E225M	2.2µF	0805	25V
Murata	GRM219R61E225KA12	2.2µF	0805	25V

### Inductor Selection

The LM3509 is designed for use with a 10µH inductor, however 22µH are suitable providing the output capacitor is increased 2x's. When selecting the inductor ensure that the saturation current rating ( $I_{SAT}$ ) for the chosen inductor is high enough and the inductor is large enough such that at the maximum LED current the peak inductor current is less than the LM3509's peak switch current limit. This is done by choosing:

$$I_{SAT} > \frac{I_{LED}}{\eta} \times \frac{V_{OUT}}{V_{IN}} + \Delta I_L \quad \text{where}$$

$$\Delta I_L = \frac{V_{IN} \times (V_{OUT} - V_{IN})}{2 \times f_{SW} \times L \times V_{OUT}}, \text{ and}$$

$$L > \frac{V_{IN} \times (V_{OUT} - V_{IN})}{2 \times f_{SW} \times V_{OUT} \times \left( I_{PEAK} - \frac{I_{LED\_MAX} \times V_{OUT}}{\eta \times V_{IN}} \right)}$$
(8)

Values for  $I_{PEAK}$  can be found in the plot of peak current limit vs.  $V_{IN}$  in the [Typical Performance Characteristics](#) graphs. Table 8 shows possible inductors, as well as their corresponding case size and their saturation current ratings.

**Table 8. Recommended Inductors**

Manufacturer	Part Number	Value	Dimensions	$I_{SAT}$	DC Resistance
TDK	VLF3012AT-100MR49	10µH	2.6mm×2.8mm×1mm	490mA	0.36Ω
TDK	VLF4012AT-100MR79	10µH	3.5mm×3.7mm×1.2mm	800mA	0.3Ω
TOKO	A997AS-100M	10µH	3.8mm×3.8mm×1.8mm	580mA	0.18Ω

### Diode Selection

The output diode must have a reverse breakdown voltage greater than the maximum output voltage. The diodes average current rating should be high enough to handle the LM3509's output current. Additionally, the diodes peak current rating must be high enough to handle the peak inductor current. Schottky diodes are recommended due to their lower forward voltage drop (0.3V to 0.5V) compared to (0.6V to 0.8V) for PN junction diodes. If a PN junction diode is used, ensure it is the ultra-fast type ( $t_{rr} < 50\text{ns}$ ) to prevent excessive loss in the rectifier. For Schottky diodes the B05030WS (or equivalent) work well for most designs. See [Table 9](#) for a list of other Schottky Diodes with similar performance.

**Table 9. Recommended Schottky Diodes**

Manufacturer	Part Number	Package	Reverse Breakdown Voltage	Average Current Rating
Diodes Inc.	B05030WS	SOD-323	30V	0.5A
Philips	BAT760	SOD-323	23V	1A
ON Semiconductor	NSR0320MW2T	SOD-323	30V	1A

### Output Current Range (OLED Mode)

The maximum output current the LM3509 can deliver in OLED mode is limited by 4 factors (assuming continuous conduction); the peak current limit of 770mA (typical), the inductor value, the input voltage, and the output voltage. Calculate the maximum output current ( $I_{OUT\_MAX}$ ) using the following equation:

$$I_{OUT\_MAX} = \frac{(I_{PEAK} - \Delta I_L) \times \eta \times V_{IN}}{V_{OUT}}$$

where

$$\Delta I_L = \frac{V_{IN} \times (V_{OUT} - V_{IN})}{2 \times f_{SW} \times L \times V_{OUT}}$$

(9)

For the typical application circuit with  $V_{OUT} = 18\text{V}$  and assuming 70% efficiency, the maximum output current at  $V_{IN} = 2.7\text{V}$  will be approximately 70mA. At 4.2V due to the shorter on times and lower average input currents the maximum output current (at 70% efficiency) jumps to approximately 105mA. [Figure 47](#) shows a plot of  $I_{OUT\_MAX}$  vs.  $V_{IN}$  using the above equation, assuming 80% efficiency. In reality factors such as current limit and efficiency will vary over  $V_{IN}$ , temperature, and component selection. This can cause the actual  $I_{OUT\_MAX}$  to be higher or lower.

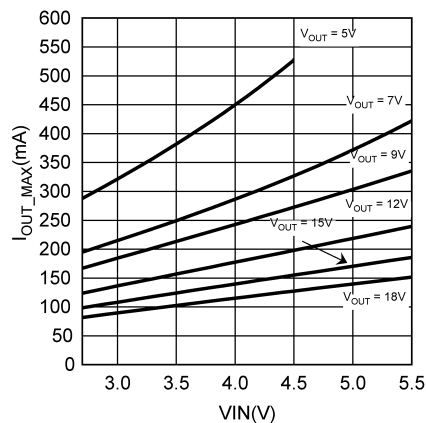

**Figure 47. Typical Maximum Output Current in OLED Mode**

### Output Voltage Range (OLED Mode)

The LM3509's output voltage is constrained by 2 factors. On the low end it is limited by the minimum duty cycle of 10% (assuming continuous conduction) and on the high end it is limited by the over voltage protection threshold ( $V_{OVP}$ ) of 22V (typical). In order to maintain stability when operating at different output voltages the output capacitor and inductor must be changed. Refer to [Table 10](#) for different  $V_{OUT}$ ,  $C_{OUT}$ , and L combinations.

**Table 10. Component Values for Output Voltage Selection**

$V_{OUT}$	$C_{OUT}$	L	$V_{IN}$ Range
18V	2.2 $\mu$ F	10 $\mu$ H	2.7V to 5.5V
15V	2.2 $\mu$ F	10 $\mu$ H	2.7V to 5.5V
12V	4.7 $\mu$ F	10 $\mu$ H	2.7V to 5.5V
9V	10 $\mu$ F	10 $\mu$ H	2.7V to 5.5V
7V	10 $\mu$ F	4.7 $\mu$ H	2.7V to 5.5V
5V	22 $\mu$ F	4.7 $\mu$ H	2.7V to 4.5V

### Layout Considerations

The WSON is a leadless package with very good thermal properties. This package has an exposed DAP (die attach pad) at the underside center of the package measuring 1.6mm x 2.0mm. The main advantage of this exposed DAP is to offer low thermal resistance when soldered to the thermal ground pad on the PCB. For good PCB layout a 1:1 ratio between the package and the PCB thermal land is recommended. To further enhance thermal conductivity, the PCB thermal ground pad may include vias to a 2nd layer ground plane. For more detailed instructions on mounting WSON packages, please refer to Texas Instrument Application Note AN-1187 (Literature Number [SNOA401](#)).

The high switching frequencies and large peak currents make the PCB layout a critical part of the design. The proceeding steps must be followed to ensure stable operation and proper current source regulation.

1. Divide ground into two planes, one for the return terminals of  $C_{OUT}$ ,  $C_{IN}$  and the I<sup>2</sup>C Bus, the other for the return terminals of  $R_{SET}$  and the feedback network. Connect both planes to the exposed PAD, but nowhere else.
2. Connect the inductor and the anode of D1 as close together as possible and place this connection as close as possible to the SW pin. This reduces the inductance and resistance of the switching node which minimizes ringing and excess voltage drops. This will improve efficiency and decrease noise that can get injected into the current sources.
3. Connect the return terminals of the input capacitor and the output capacitor as close as possible to the exposed PAD and through low impedance traces.
4. Bypass IN with at least a 1 $\mu$ F ceramic capacitor. Connect the positive terminal of this capacitor as close as possible to IN.
5. Connect  $C_{OUT}$  as close as possible to the cathode of D1. This reduces the inductance and resistance of the output bypass node which minimizes ringing and the excess voltage drops. This will improving efficiency and decrease noise that can get injected into the current sources.
6. Route the traces for  $R_{SET}$  and the feedback divider away from the SW node to minimize noise injection.
7. Do not connect any external capacitance to the SET pin.



---

**REVISION HISTORY**

<b>Changes from Revision C (May 2013) to Revision D</b>	<b>Page</b>
<hr/> <ul style="list-style-type: none"><li>• Changed layout of National Data Sheet to TI format .....</li></ul>	<hr/> <a href="#">24</a>

**PACKAGING INFORMATION**

Orderable Device	Status (1)	Package Type	Package Drawing	Pins	Package Qty	Eco Plan (2)	Lead finish/ Ball material (6)	MSL Peak Temp (3)	Op Temp (°C)	Device Marking (4/5)	Samples
LM3509SD/NOPB	ACTIVE	WSON	DSC	10	1000	RoHS & Green	SN	Level-3-260C-168 HR	-40 to 85	L3509	<a href="#">Samples</a>
LM3509SDE/NOPB	ACTIVE	WSON	DSC	10	250	RoHS & Green	SN	Level-3-260C-168 HR	-40 to 85	L3509	<a href="#">Samples</a>
LM3509SDX/NOPB	ACTIVE	WSON	DSC	10	4500	RoHS & Green	SN	Level-3-260C-168 HR	-40 to 85	L3509	<a href="#">Samples</a>

(1) The marketing status values are defined as follows:

**ACTIVE:** Product device recommended for new designs.

**LIFEBUY:** TI has announced that the device will be discontinued, and a lifetime-buy period is in effect.

**NRND:** Not recommended for new designs. Device is in production to support existing customers, but TI does not recommend using this part in a new design.

**PREVIEW:** Device has been announced but is not in production. Samples may or may not be available.

**OBSELETE:** TI has discontinued the production of the device.

(2) **RoHS:** TI defines "RoHS" to mean semiconductor products that are compliant with the current EU RoHS requirements for all 10 RoHS substances, including the requirement that RoHS substance do not exceed 0.1% by weight in homogeneous materials. Where designed to be soldered at high temperatures, "RoHS" products are suitable for use in specified lead-free processes. TI may reference these types of products as "Pb-Free".

**RoHS Exempt:** TI defines "RoHS Exempt" to mean products that contain lead but are compliant with EU RoHS pursuant to a specific EU RoHS exemption.

**Green:** TI defines "Green" to mean the content of Chlorine (Cl) and Bromine (Br) based flame retardants meet JS709B low halogen requirements of <=1000ppm threshold. Antimony trioxide based flame retardants must also meet the <=1000ppm threshold requirement.

(3) MSL, Peak Temp. - The Moisture Sensitivity Level rating according to the JEDEC industry standard classifications, and peak solder temperature.

(4) There may be additional marking, which relates to the logo, the lot trace code information, or the environmental category on the device.

(5) Multiple Device Markings will be inside parentheses. Only one Device Marking contained in parentheses and separated by a "~" will appear on a device. If a line is indented then it is a continuation of the previous line and the two combined represent the entire Device Marking for that device.

(6) Lead finish/Ball material - Orderable Devices may have multiple material finish options. Finish options are separated by a vertical ruled line. Lead finish/Ball material values may wrap to two lines if the finish value exceeds the maximum column width.

**Important Information and Disclaimer:**The information provided on this page represents TI's knowledge and belief as of the date that it is provided. TI bases its knowledge and belief on information provided by third parties, and makes no representation or warranty as to the accuracy of such information. Efforts are underway to better integrate information from third parties. TI has taken and continues to take reasonable steps to provide representative and accurate information but may not have conducted destructive testing or chemical analysis on incoming materials and chemicals. TI and TI suppliers consider certain information to be proprietary, and thus CAS numbers and other limited information may not be available for release.

In no event shall TI's liability arising out of such information exceed the total purchase price of the TI part(s) at issue in this document sold by TI to Customer on an annual basis.

**TAPE AND REEL INFORMATION**

**QUADRANT ASSIGNMENTS FOR PIN 1 ORIENTATION IN TAPE**

\*All dimensions are nominal

Device	Package Type	Package Drawing	Pins	SPQ	Reel Diameter (mm)	Reel Width W1 (mm)	A0 (mm)	B0 (mm)	K0 (mm)	P1 (mm)	W (mm)	Pin1 Quadrant
LM3509SD/NOPB	WSON	DSC	10	1000	178.0	12.4	3.3	3.3	1.0	8.0	12.0	Q1
LM3509SDE/NOPB	WSON	DSC	10	250	178.0	12.4	3.3	3.3	1.0	8.0	12.0	Q1
LM3509SDX/NOPB	WSON	DSC	10	4500	330.0	12.4	3.3	3.3	1.0	8.0	12.0	Q1

**TAPE AND REEL BOX DIMENSIONS**



\*All dimensions are nominal

Device	Package Type	Package Drawing	Pins	SPQ	Length (mm)	Width (mm)	Height (mm)
LM3509SD/NOPB	WSON	DSC	10	1000	208.0	191.0	35.0
LM3509SDE/NOPB	WSON	DSC	10	250	208.0	191.0	35.0
LM3509SDX/NOPB	WSON	DSC	10	4500	356.0	356.0	35.0

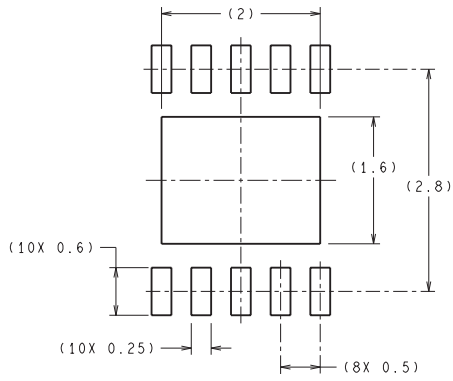
DSC0010A

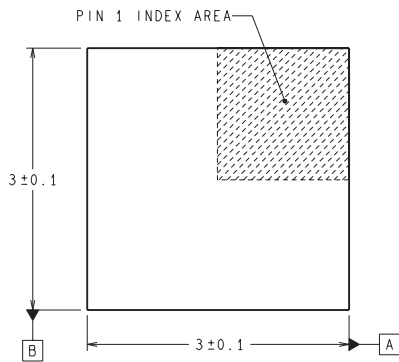

RECOMMENDED LAND PATTERN



DIMENSIONS ARE IN MILLIMETERS  
DIMENSIONS IN ( ) FOR REFERENCE ONLY

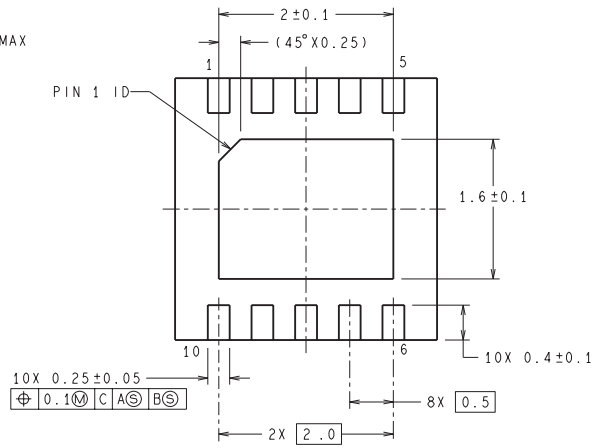
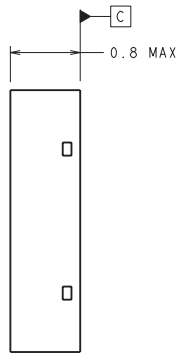
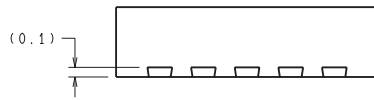

SDA10A (Rev A)

## IMPORTANT NOTICE AND DISCLAIMER

TI PROVIDES TECHNICAL AND RELIABILITY DATA (INCLUDING DATA SHEETS), DESIGN RESOURCES (INCLUDING REFERENCE DESIGNS), APPLICATION OR OTHER DESIGN ADVICE, WEB TOOLS, SAFETY INFORMATION, AND OTHER RESOURCES "AS IS" AND WITH ALL FAULTS, AND DISCLAIMS ALL WARRANTIES, EXPRESS AND IMPLIED, INCLUDING WITHOUT LIMITATION ANY IMPLIED WARRANTIES OF MERCHANTABILITY, FITNESS FOR A PARTICULAR PURPOSE OR NON-INFRINGEMENT OF THIRD PARTY INTELLECTUAL PROPERTY RIGHTS.

These resources are intended for skilled developers designing with TI products. You are solely responsible for (1) selecting the appropriate TI products for your application, (2) designing, validating and testing your application, and (3) ensuring your application meets applicable standards, and any other safety, security, regulatory or other requirements.

These resources are subject to change without notice. TI grants you permission to use these resources only for development of an application that uses the TI products described in the resource. Other reproduction and display of these resources is prohibited. No license is granted to any other TI intellectual property right or to any third party intellectual property right. TI disclaims responsibility for, and you will fully indemnify TI and its representatives against, any claims, damages, costs, losses, and liabilities arising out of your use of these resources.

TI's products are provided subject to [TI's Terms of Sale](#) or other applicable terms available either on [ti.com](http://ti.com) or provided in conjunction with such TI products. TI's provision of these resources does not expand or otherwise alter TI's applicable warranties or warranty disclaimers for TI products.

TI objects to and rejects any additional or different terms you may have proposed.

Mailing Address: Texas Instruments, Post Office Box 655303, Dallas, Texas 75265  
Copyright © 2022, Texas Instruments Incorporated